

Solar Powering Your Community Workshop: North Charleston, SC



Powered by

SunShot

U.S. Department of Energy

May 15, 2015

- Casey Logan, **SCANA**
- Eddie Plowden, **Berkeley Co. Electric Cooperative**
- Brian Burdly, **Santee Cooper**
- David Morley, **American Planning Association, Solar Outreach Partnership**
- Sky Stanfield and Erica McConnell, **Keyes, Fox & Weidman, Solar Outreach Partnership**
- Shawn Stickle, **SC Fire Marshall**
- Ray Reckelhoff, **SC Fire Academy**

Here Comes the Sunshine.



Solar Workshop for Municipal Employees
May 14, 2015
SCANA Headquarters - Cayce, SC



What is renewable energy?

- Energy resources that are naturally replenishing and virtually inexhaustible.
- Many sources are intermittent (non-dispatchable).
- Includes **solar, wind, biomass, hydro, geothermal, recycling resources, hydrogen, tidal and wave resources, and combined heat and power (CHP) from renewables**

Renewable Energy at SCE&G

- **Biomass**
55 MW (Kapstone)
- **Solar**
4 MW existing (~300 customers).
- **Hydro**
221 MW (Saluda, Neal Shoals, Parr, Stevens Creek)
- **Wind**
SCE&G Innovation Center - Wind Turbine Drive Train Testing facility at
Clemson University Research Institute



SCE&G Solar Customer Locations

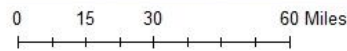
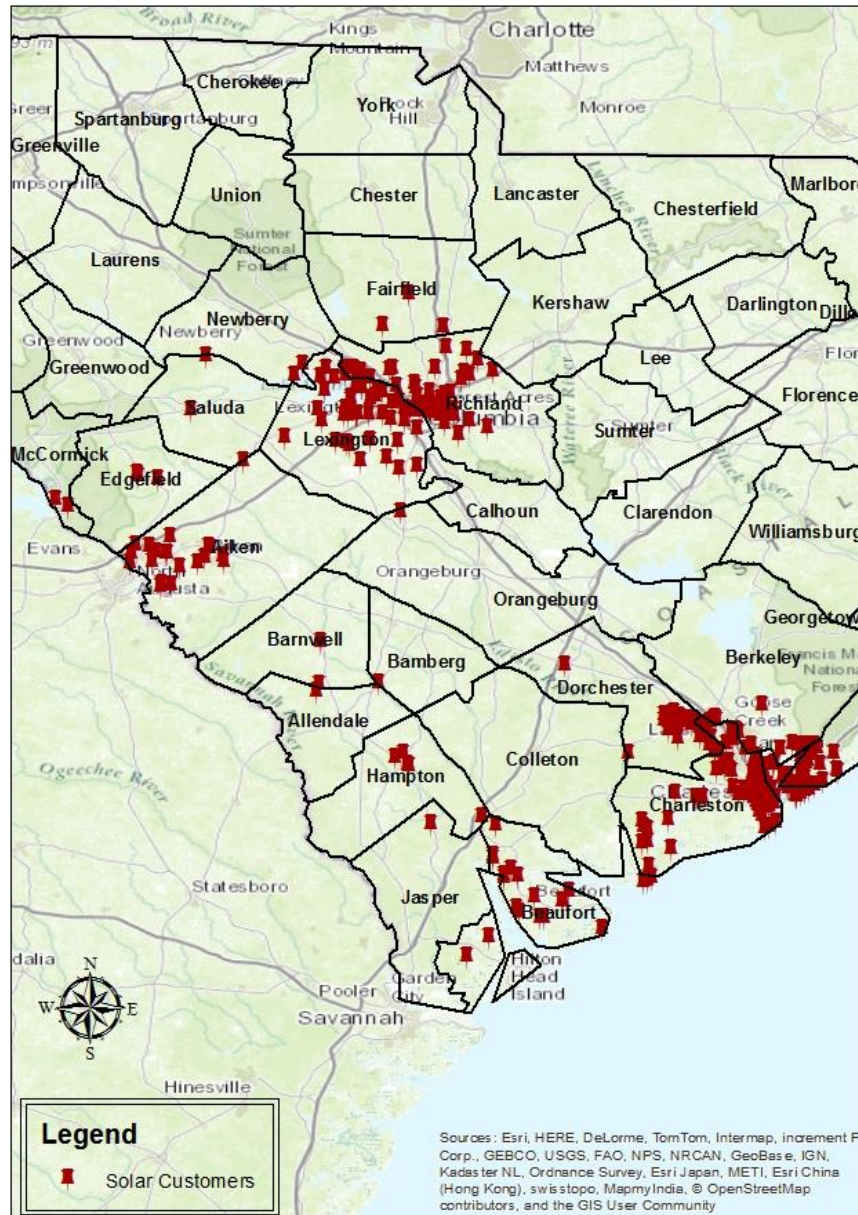

Why Focus On Solar?

- Increasing customer interest.
- Cost of solar has decreased by more than 60%+ since 2008.
- Solar is scalable.



Select Solar Sizing and Costs

- **Residential**
 - \$3.50/watt, or approx. \$14,000 for a 4 kW system
- **Small Commercial**
 - \$2.75/watt, or \$55,000 for a 20 kW system
- **Utility-Scale (Solar Farm)**
 - \$2.00/watt, or \$2 million per MW

Note: Costs are subject to market changes, potential financing expenses and specifications for each installation such as existing roofs or new construction.



VALUE of the GRID

SCE&G System Load and 4kW Solar Max Output

Summer Day

Rooftop solar customers
use the grid...

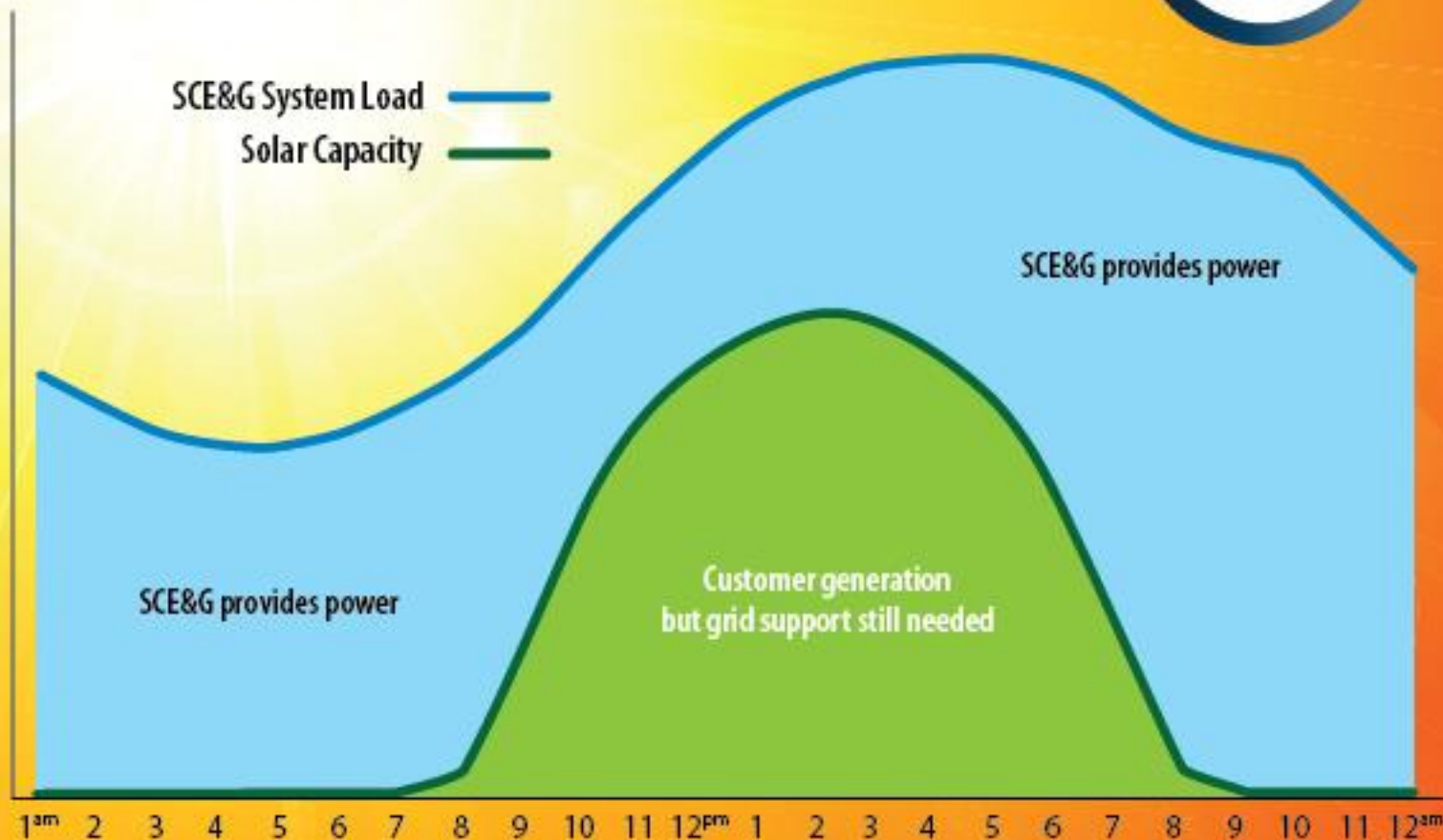

Note: The peak for solar generation and the peak for usage on our system do not coincide.

S.C. Distributed Energy Resource Program Act 236

Directs Investor Owned Utilities by 12/31/2020:

- To develop customer incentives to promote the establishment of renewables
- Meet goals of 42 MW utility-scale farms, and 42 MW customer-scale installations

Cumulative Solar Participants

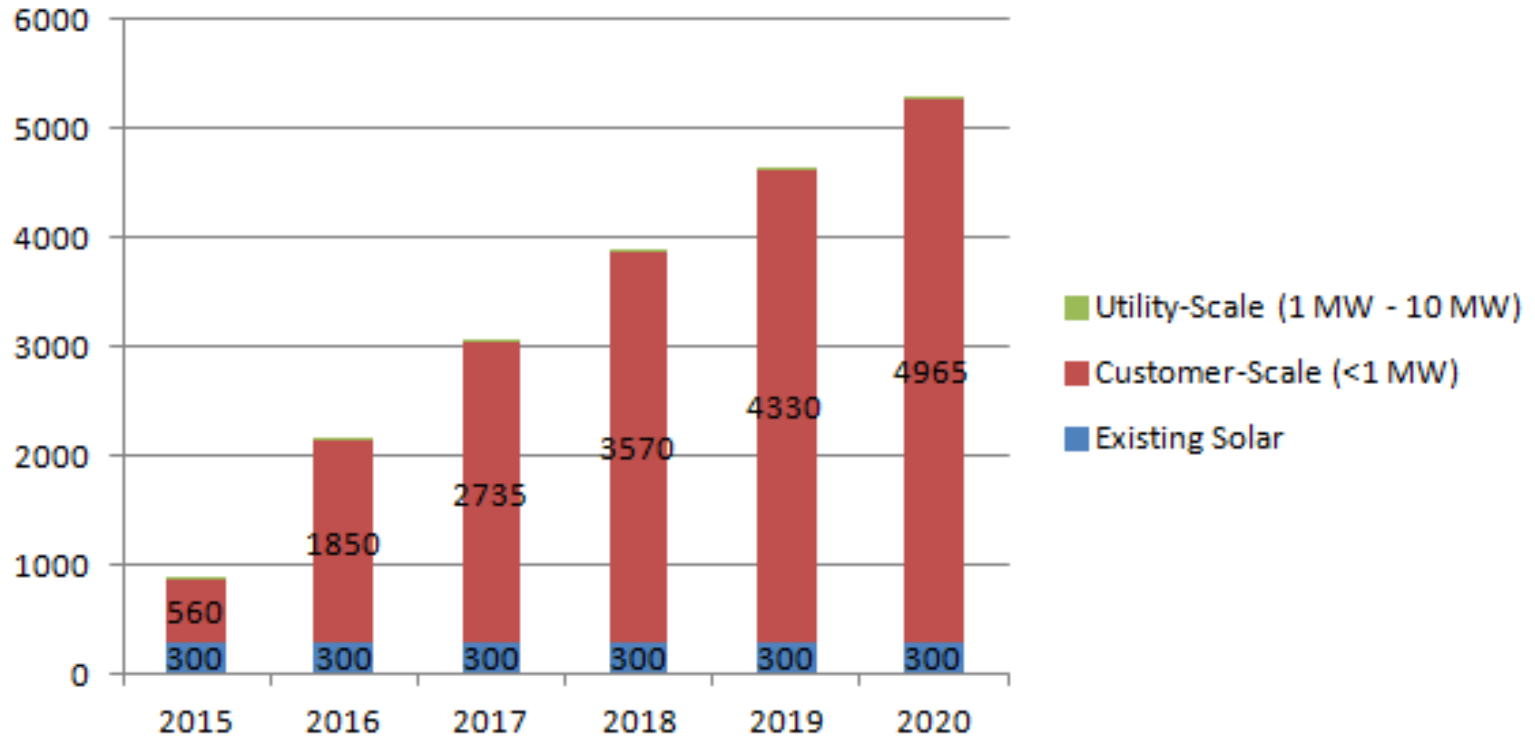

Cumulative Solar MW

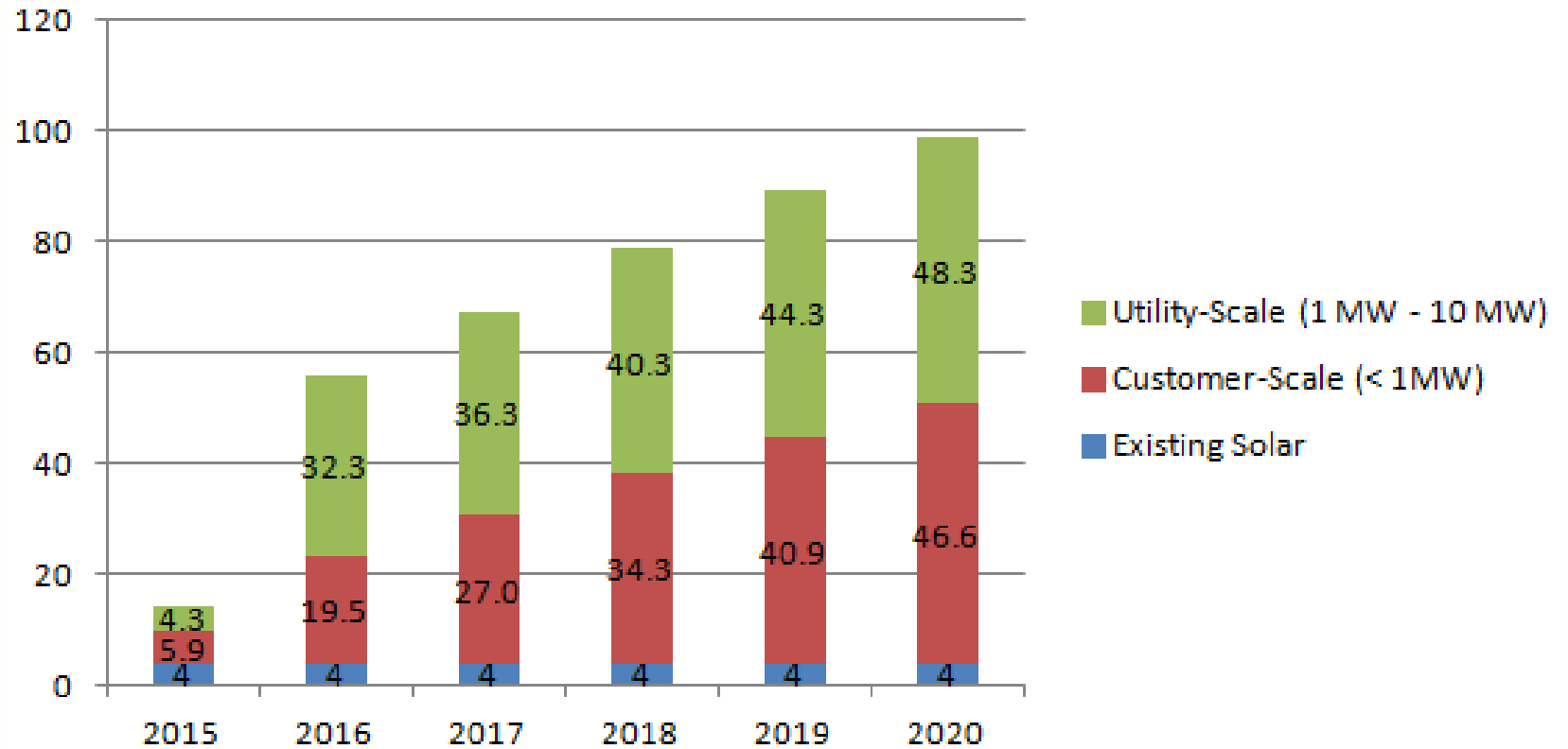

Thank You

Casey Logan
Renewable Products/Services and Energy Demand Management
cjlogan@scana.com



Solar 101



 Powered by
SunShot
U.S. Department of Energy

SunShot Solar Outreach Partnership



The SunShot Solar Outreach Partnership (SolarOPs) is a U.S. Department of Energy (DOE) program designed to increase the use and integration of solar energy in communities across the United States.

<http://solaroutreach.org>

Complimentary Services



Technical
Resources



Regional
Workshops



One to One
Assistance



Strategy
Session

Focus Areas

- Streamlining and standardizing **permitting and interconnection processes**
- Improving **planning and zoning codes/regulations** for solar electric technologies
- Increasing access to **solar financing options**

There Are Multiple Solar Technologies

Passive Solar Design

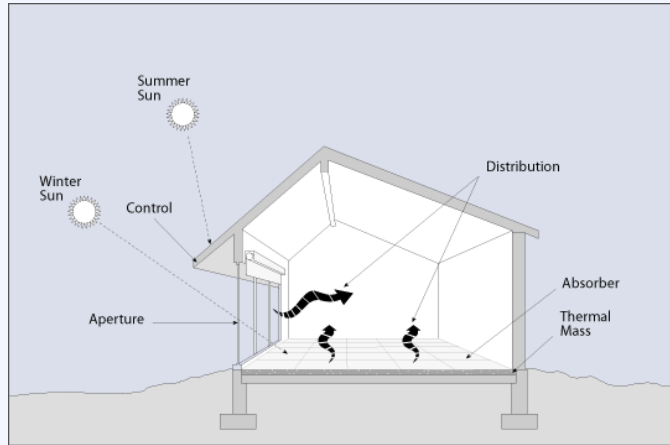

Solar Photovoltaic (PV) Systems

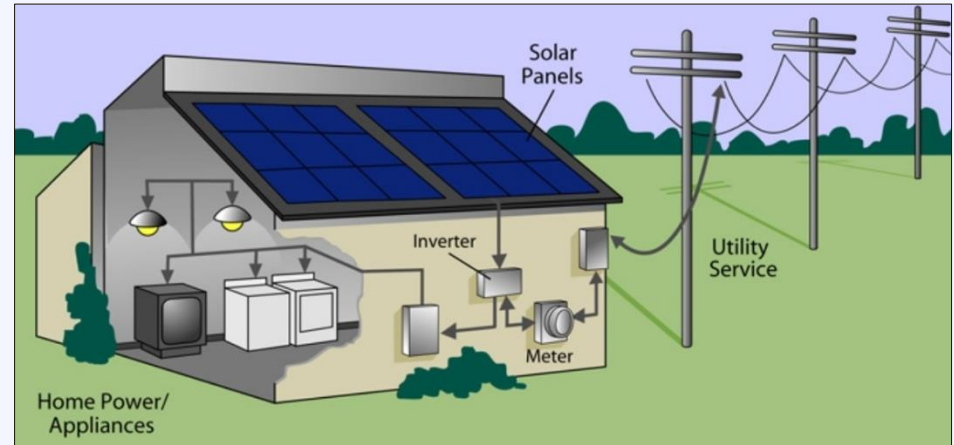

Solar Thermal Systems

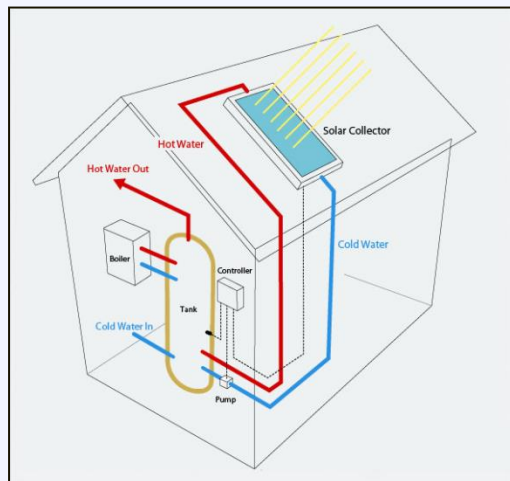

Concentrating Solar Power

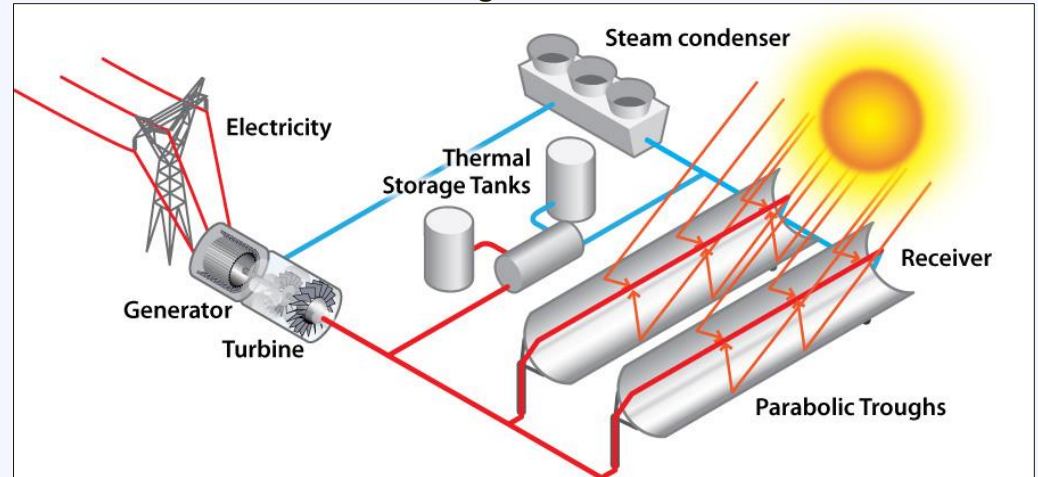

Some Basic Terminology

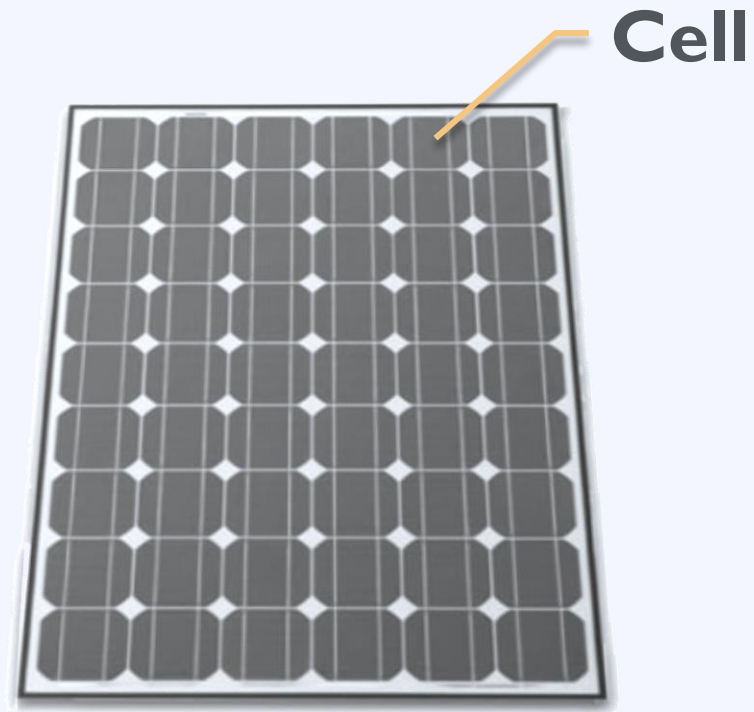

Panel / Module

Some Basic Terminology

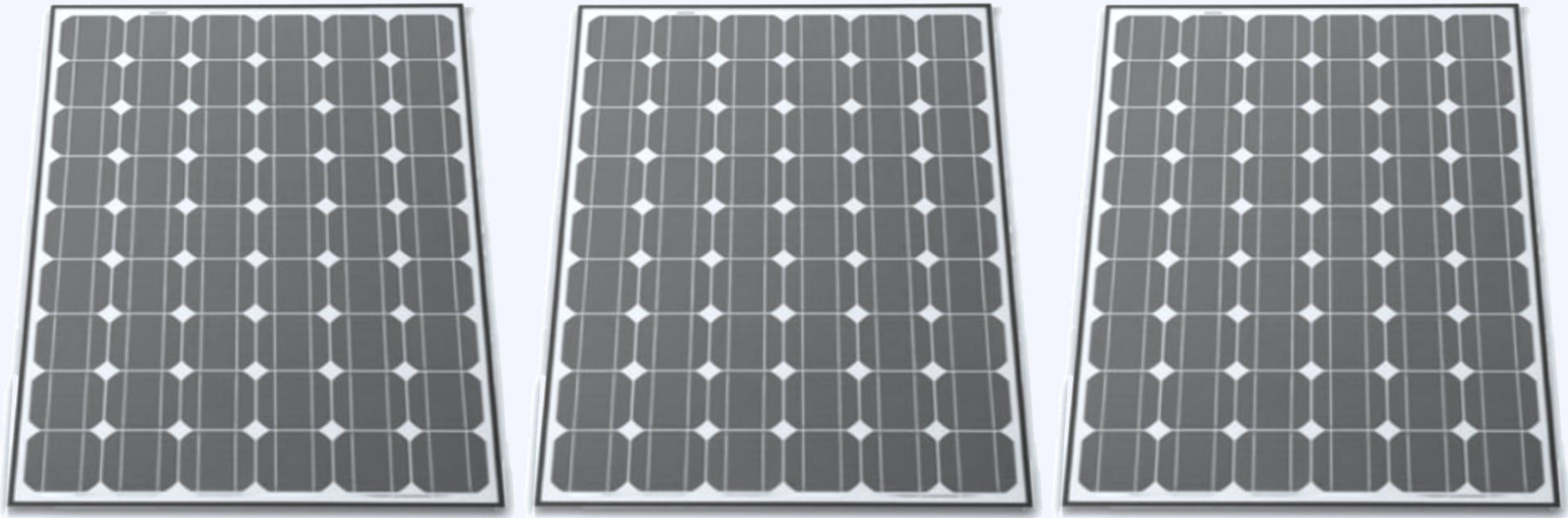

Array

Some Basic Terminology



Building-Mounted (Rooftop) Systems

Some Basic Terminology



Ground-Mounted (Freestanding) Systems

Some Basic Terminology



Building-Integrated Systems

Some Basic Terminology

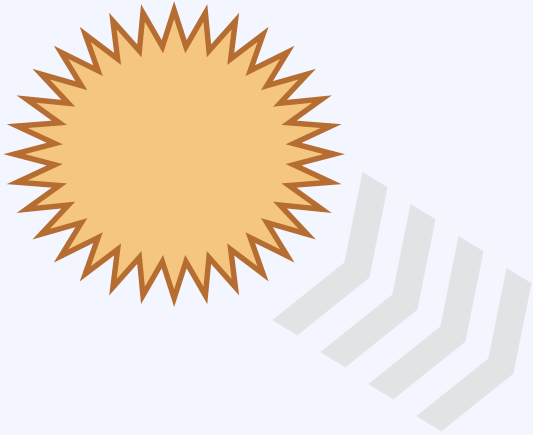

Irradiance

*Kilowatt-
hours/square meter
(kWh/m²)*

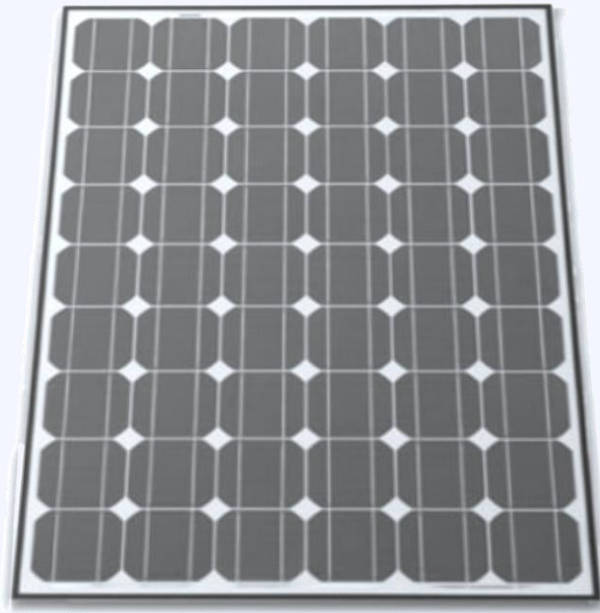

Capacity / Power

kilowatt (kW)

Production

Kilowatt-hour (kWh)

Some Basic Terminology



Residence
5 kW



Factory
1 MW+



Office
50 – 500 kW



Utility
2 MW+

Some Basic Terminology



Net metering allows customers to export power to the grid during times of excess generation, and receive credits that can be applied to later electricity usage

Some Basic Terminology

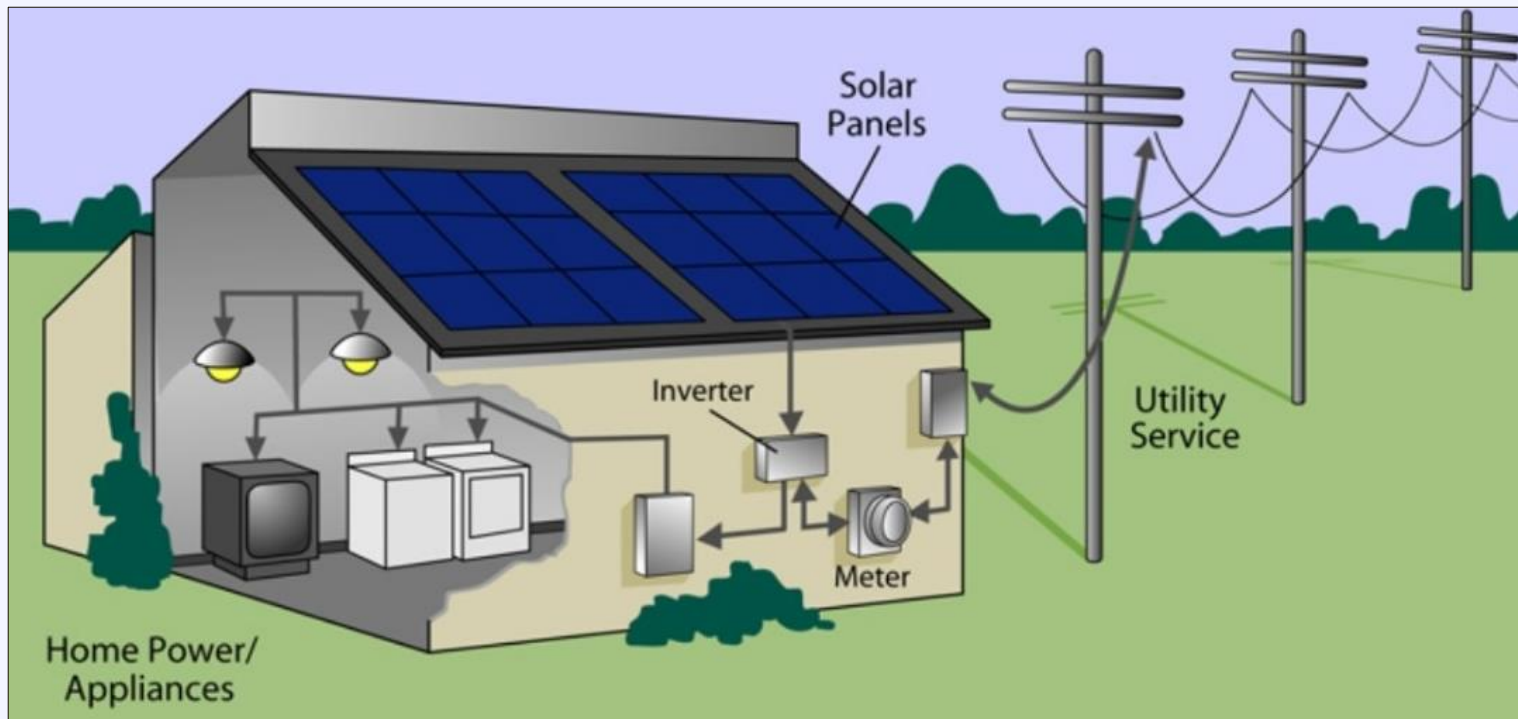

Interconnection refers to the process of tying a PV system into the local utility's grid.

Planning and Zoning for Solar Energy



Overview

- **Planning for Solar Energy Use**
 - Establishing a community vision
 - Prioritizing locations
 - Adding vision and priorities to local plans
- **Zoning for Solar Energy Use**
 - Defining solar uses
 - Establishing clear use permissions
 - Adopting appropriate standards
 - Adopting complimentary development regulations

Key APA Resources

- Planning for Solar Energy (PAS 575):

www.planning.org/store/product/?ProductCode=BOOK_P575

- Solar Planning and Zoning Data Search:

www.planning.org/solar/data/

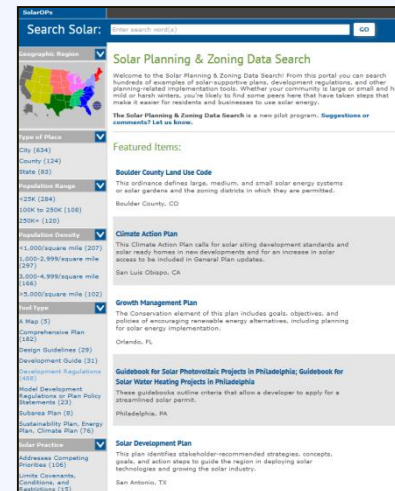
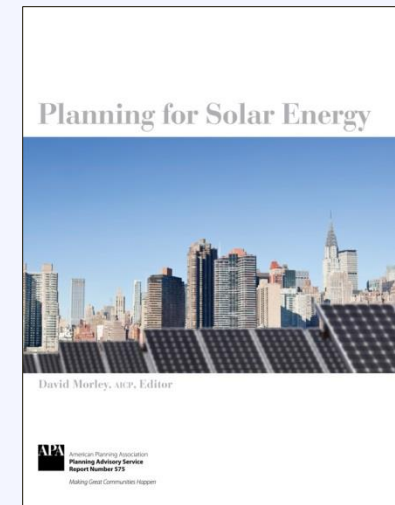



Planning for Solar Energy Use: Establishing a Community Vision

Consider How Solar Energy Use Relates to a Long-Term Vision for Growth or Change



A Planning Perspective on Solar Energy Use

Solar Irradiance Is a Local Resource.

- It can be used to produce heat or electricity.
- But using it may affect the use or conservation of other resources.

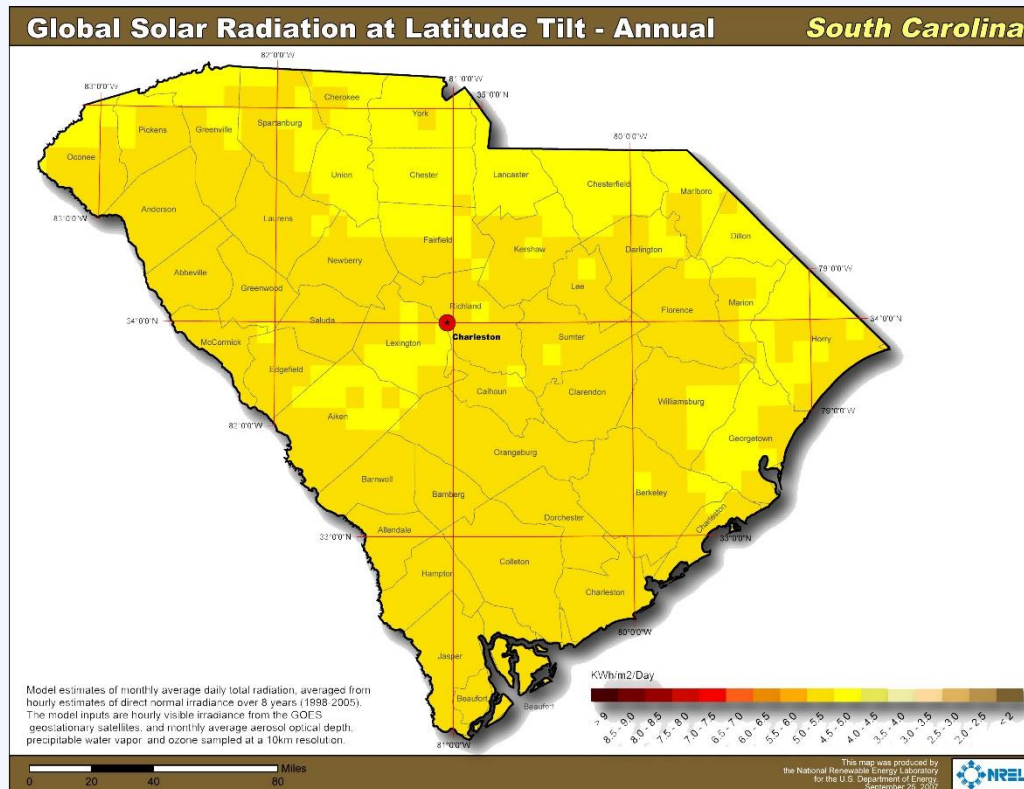

Communities Pursue Many Goals



Solar Energy Use Relates to Multiple Goals

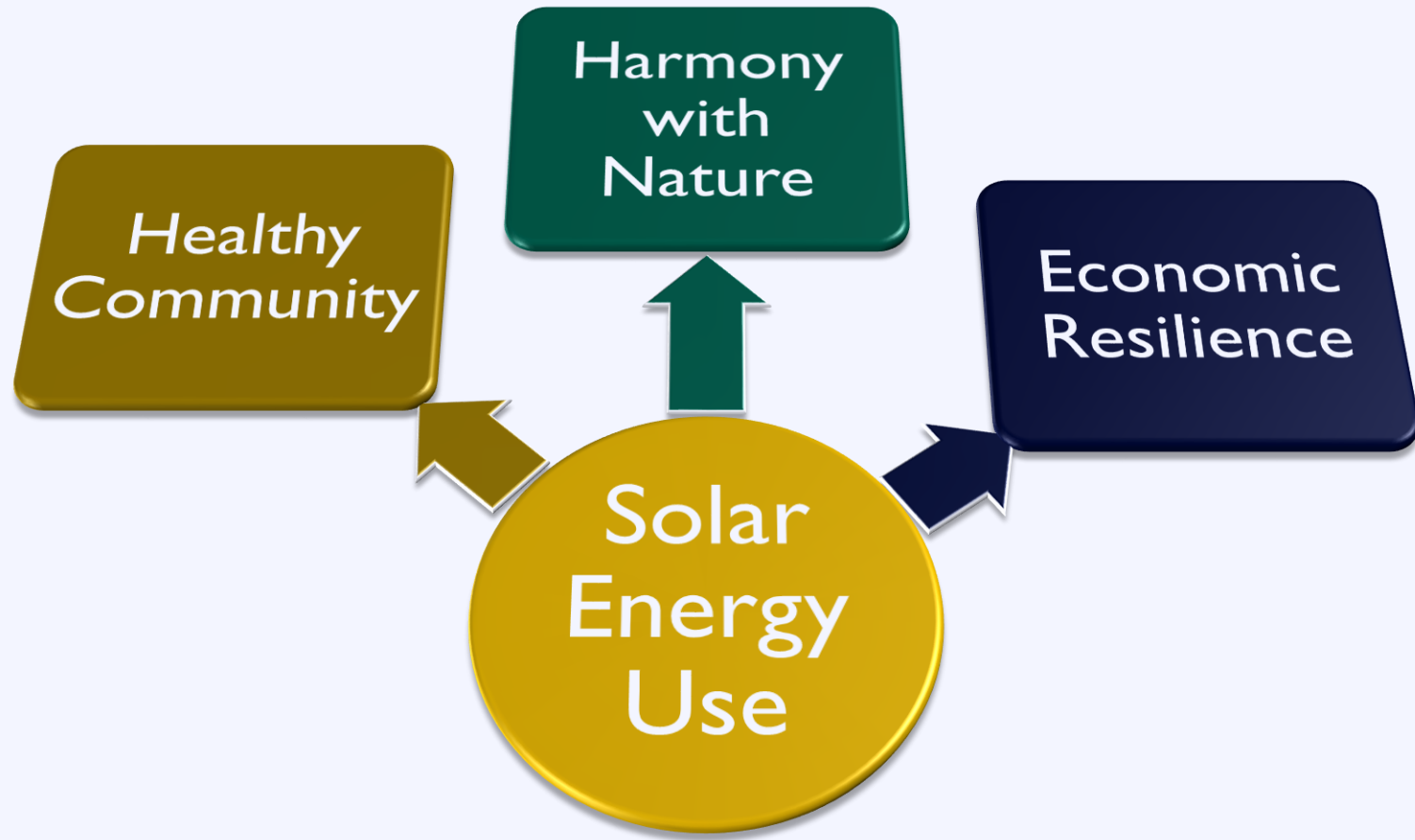

Solar Energy Use Is a Strategy

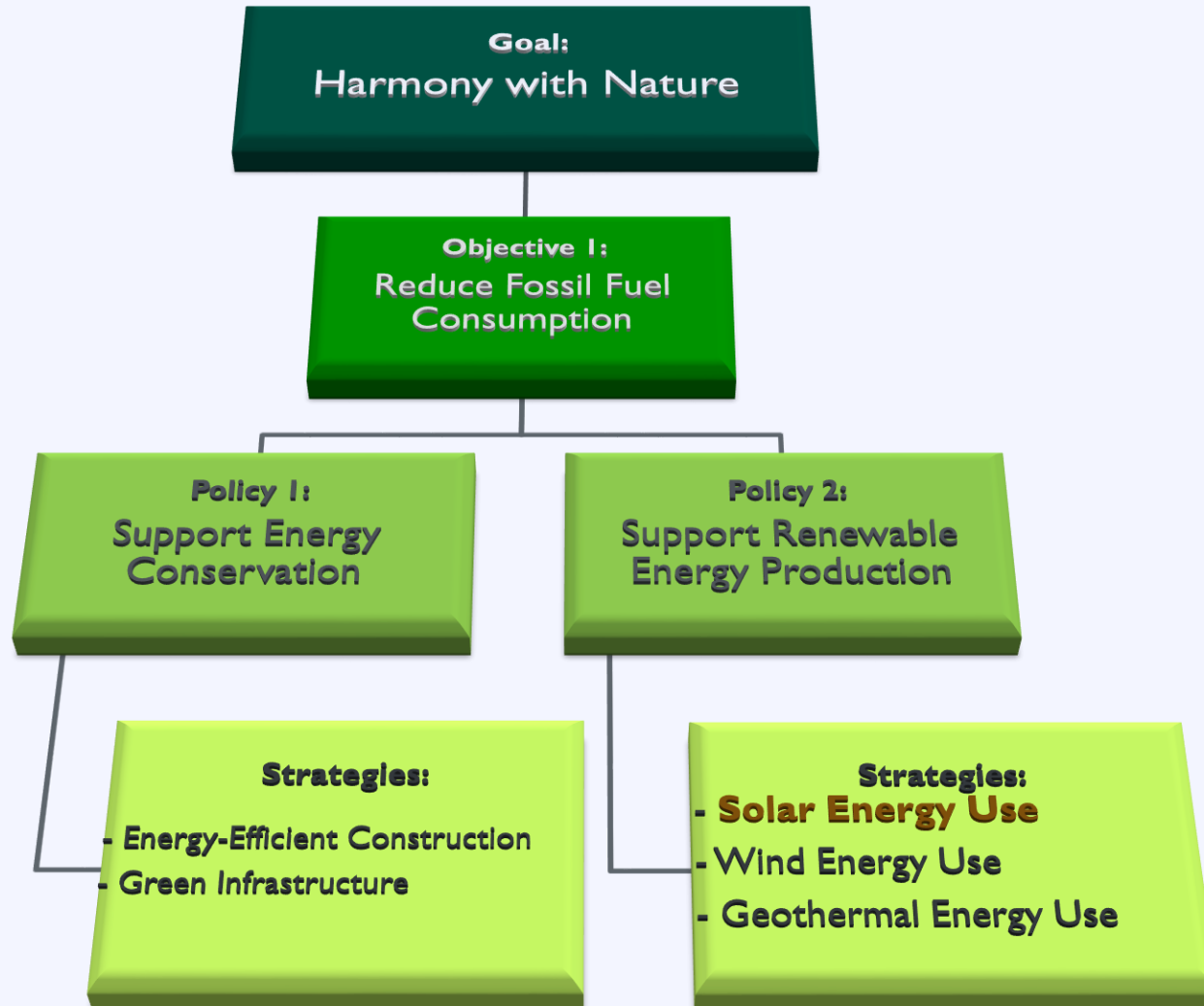

An isometric illustration featuring several stylized buildings and data storage cylinders. The buildings are depicted in shades of blue and white, with some having window patterns. The cylinders represent data storage or databases. The scene is set against a light blue background with a subtle grid pattern.

Planning for Solar Energy Use: Prioritizing Locations

Considerations

- Photovoltaic (PV) systems need unobstructed access to sunlight.
 - Freestanding systems increase siting options.
 - But, they are more vulnerable to future obstructions.

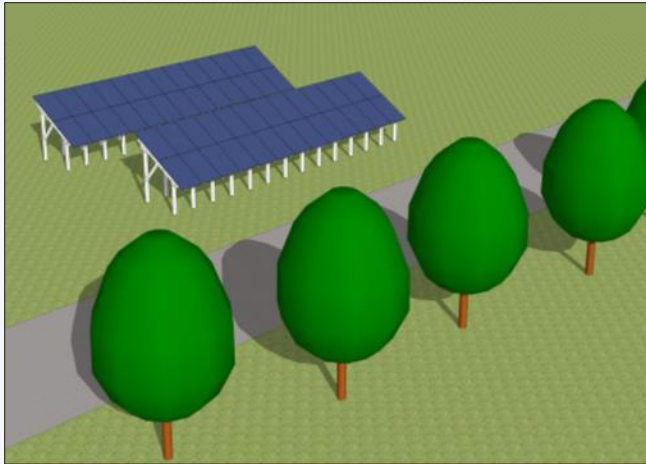

Year 0 = No shading

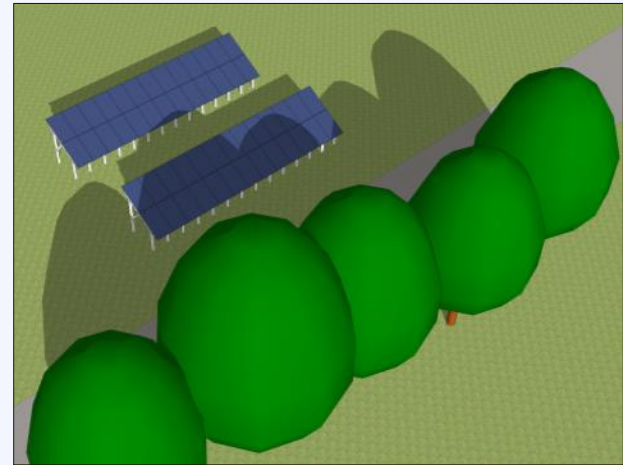

Year 20 = Major shading

Considerations

- PV systems are modular.
 - Solar installations can take up a fraction of a single residential rooftop or hundreds of acres.
 - But, there are economies of scale.



Considerations

- Potentially competing priorities



Historic Preservation

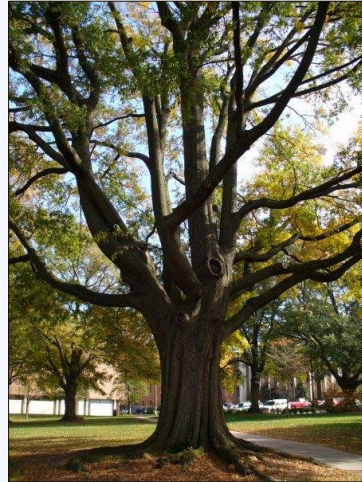

Tree Preservation



Urban Redevelopment

Considerations

- Local land-market supply and demand.
 - Some cities and counties have abundant space.
 - Low-density, primarily residential communities
 - Legacy cities with weak market demand for surplus vacant properties
 - Rural townships and counties
 - Others have fewer suitable locations.
 - Built-out cities with high demand for new housing and office space



Planning for Solar Energy Use: Incorporating Vision and Priorities into Local Plans

Why Are Plans Important?

- They put specific initiatives and actions into a larger context.

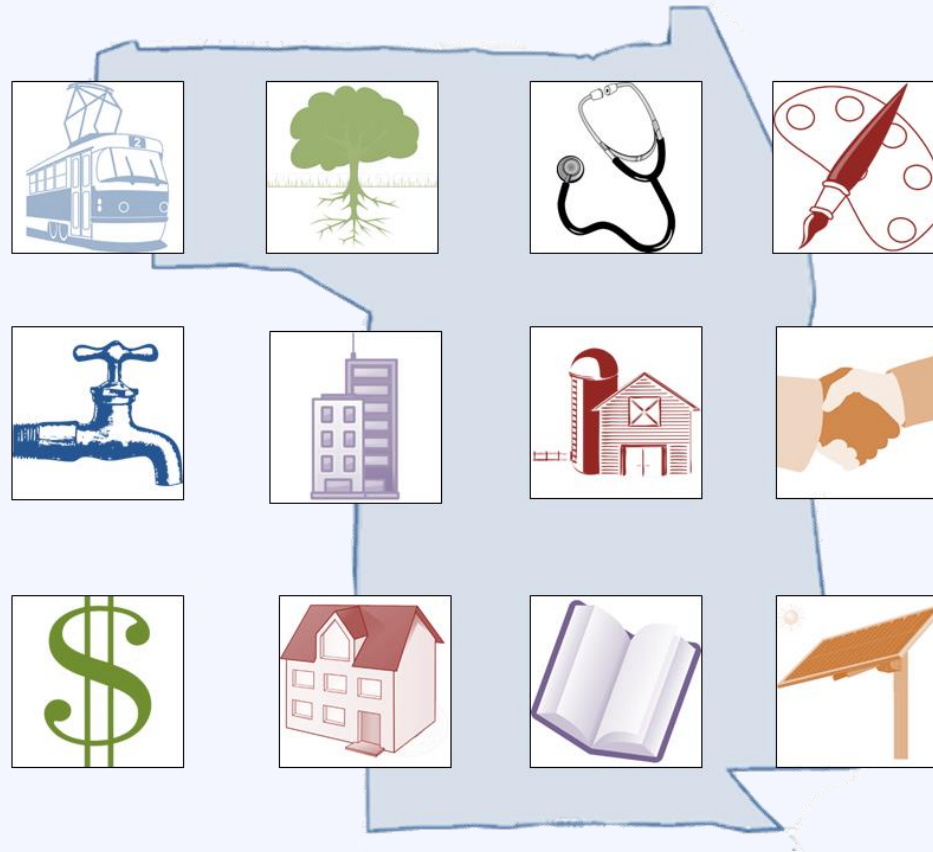

Why Are Plans Important?

- They guide decision making:
 - Provide rationale for zoning and other development regulations
 - Link programmatic and capital investments to community goals and objectives
 - Send signals to the private market about preferred types of development projects

Types of Local Plans

Communitywide Comprehensive Plan

Subarea Plans

**Neighborhood
Plans**

**Corridor
Plans**

**District
Plans**

Functional Plans

**Green
Infrastructure
Plan**

**Energy
Plan**

**Climate
Action
Plan**

What Do Your Local Plans Say?

- About where you want solar development to happen?
 - Rural areas
 - Residential neighborhoods
 - Commercial or industrial districts
 - Public land and facilities
 - Greenfield sites
 - Brownfield sites

What Do Your Local Plans Say?

- About what the local government intends to do to facilitate solar development?
 - Update development regulations
 - Install solar systems on public property
 - Explore utility partnerships
 - Create incentive programs

Clemson, SC, Comprehensive Plan 2024

- **Goal IV.4:** Promote pollution prevention practices to achieve sustainable use of natural resources, and to protect the environment and human health.
 - **Objective IV.4.3:** Increase the use of solar energy.
 - **Strategy IV.4.3.1:** Provide the public and City officials with current data and research regarding how to apply solar power.
 - **Strategy IV.4.3.2:** Explore the use of solar energy on every project built by the City.
 - **Strategy IV.4.3.3:** Explore providing incentives to encourage citizens to use solar energy.
 - **Strategy IV.4.3.4:** Work with surrounding communities to ensure an ongoing “solar friendly” relationship with local energy providers.
 - **Strategy IV.4.3.5:** Explore the use of solar energy on all City equipment and machinery.
 - **Strategy IV.4.3.6:** As public and private development occurs, be vigilant in seeking and maintaining opportunities for solar fields.
 - **Strategy IV.4.3.7:** Require all developments over two acres in size to provide evidence of having explored solar energy options as part of the approval process.

Oconee County, SC, Comprehensive Plan

- **Goal #4:** Manage our community facilities, infrastructure, and public resources in a manner that ensures both the existing population and future generations may enjoy the benefits and economic opportunities that make Oconee County an attractive and affordable place to live.
 - **Objective 3:** Upgrade solid waste facilities to improve services and allow for needed upgrades and expansion to provide for anticipated growth.
 - **Strategy 6:** Seek and establish appropriate uses for closed landfill areas, which may include, but will not be limited to, the establishment of solar power generation facilities and appropriate recreation facilities.

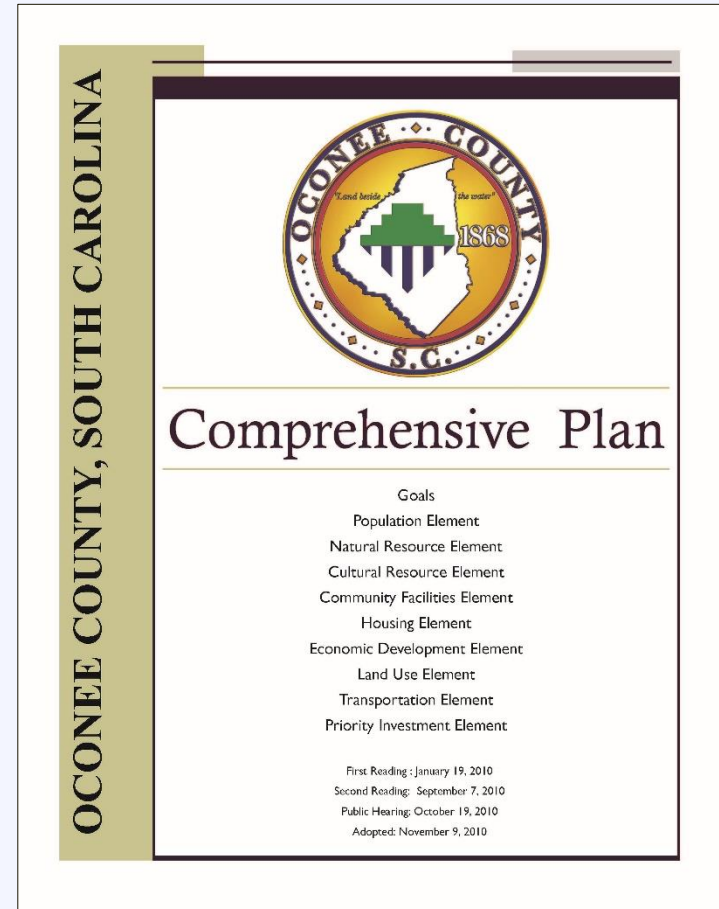

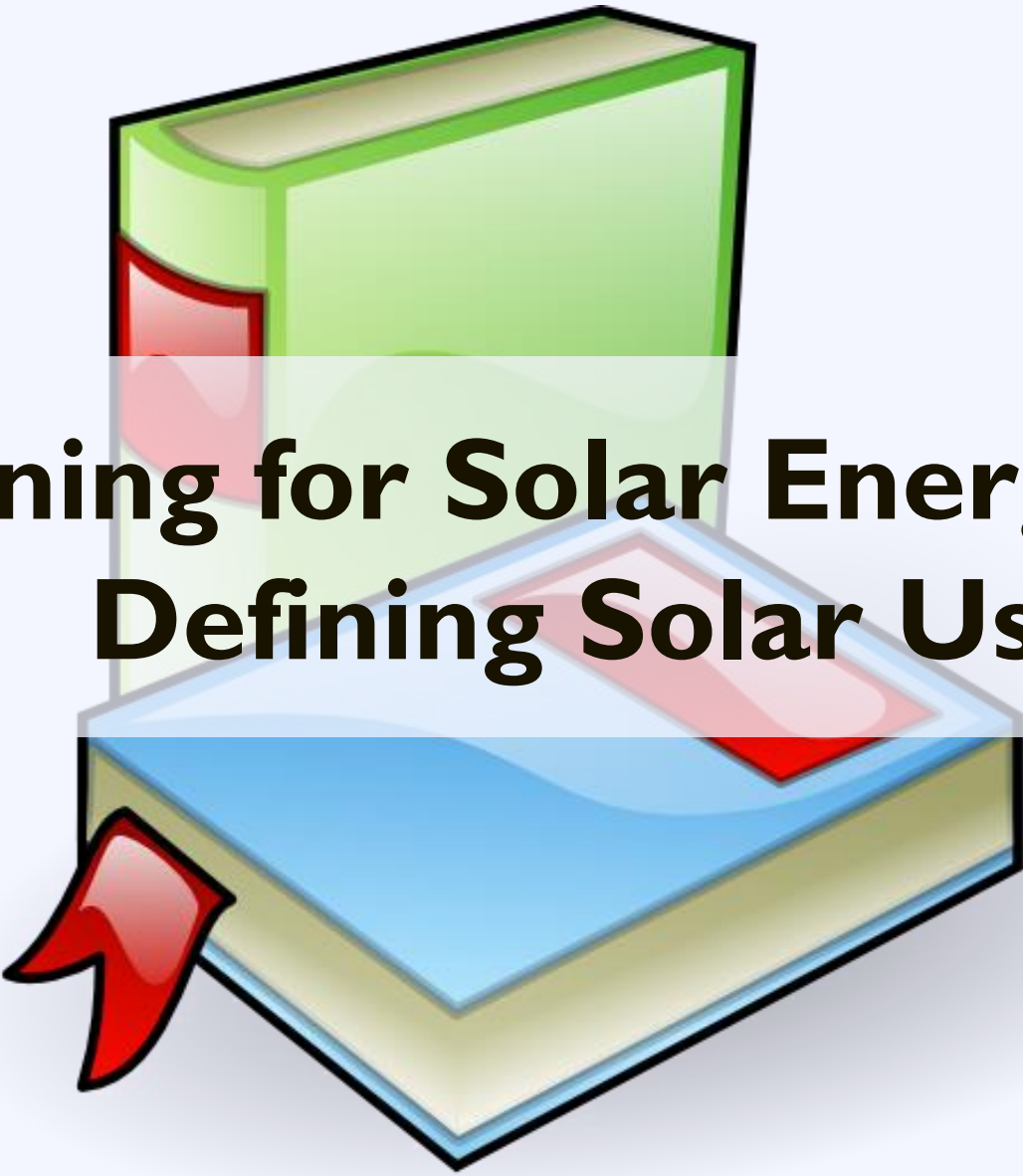

Zoning for Solar Energy Use: Defining Solar Uses

Why Are Zoning Definitions Important?

- They simplify the text by replacing complex ideas with short terms.
- They establish the precise meaning of words or phrases as used in the text.



Terms

- Define these:
 - Solar collector
 - Solar energy system
 - Building-mounted solar energy system
 - Ground-mounted (or freestanding) solar energy system
 - Building-integrated solar energy system
- Consider defining these:
 - Small ground-mounted solar energy system
 - Medium ground-mounted solar energy system
 - Large ground-mounted solar energy system

Sample Definitions

- **Solar collector:**
Any device that transforms solar radiation into thermal or electrical energy.
- **Solar energy system:**
A complete assembly consisting of one or more solar collectors and associated mounting hardware or equipment.

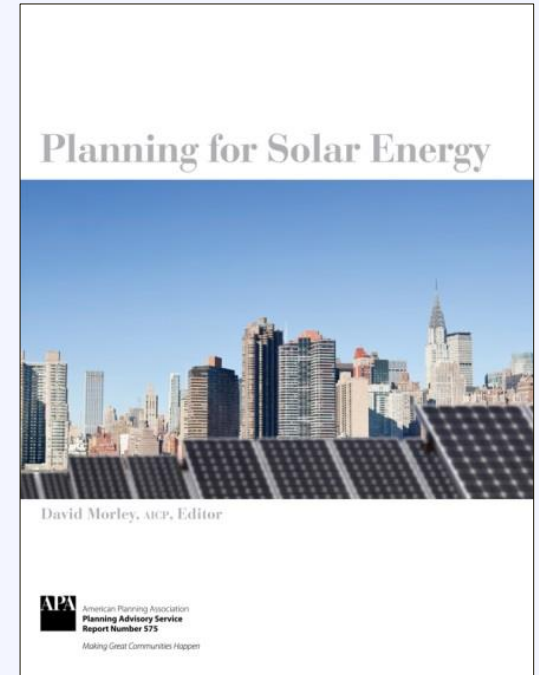

Sample Definitions

- **Building-mounted solar energy system:**
A solar energy system affixed to either a principal or accessory structure on a lot. (Minneapolis, MN)
- **Ground-mounted solar energy system:**
A solar energy system with a supporting framework that is placed on, or anchored in, the ground and that is structurally independent from any building...(Fort Collins, CO)
- **Building-integrated solar energy system:**
A solar energy system that is an integral part of a principal or accessory building, rather than a separate mechanical device, replacing or substituting for an architectural or structural component of the building...(Minneapolis, MN)

Sample Definitions

- **Small ground-mounted solar energy system:**
A ground-mounted solar energy system occupying no more than one-half acre of land.
- **Medium ground-mounted solar energy system:**
A ground-mounted solar energy system occupying between one-half acre and 10 acres of land.
- **Large ground-mounted solar energy system:**
A ground-mounted solar energy system occupying more than 10 acres of land.

(Adapted from Casco Township, MI)

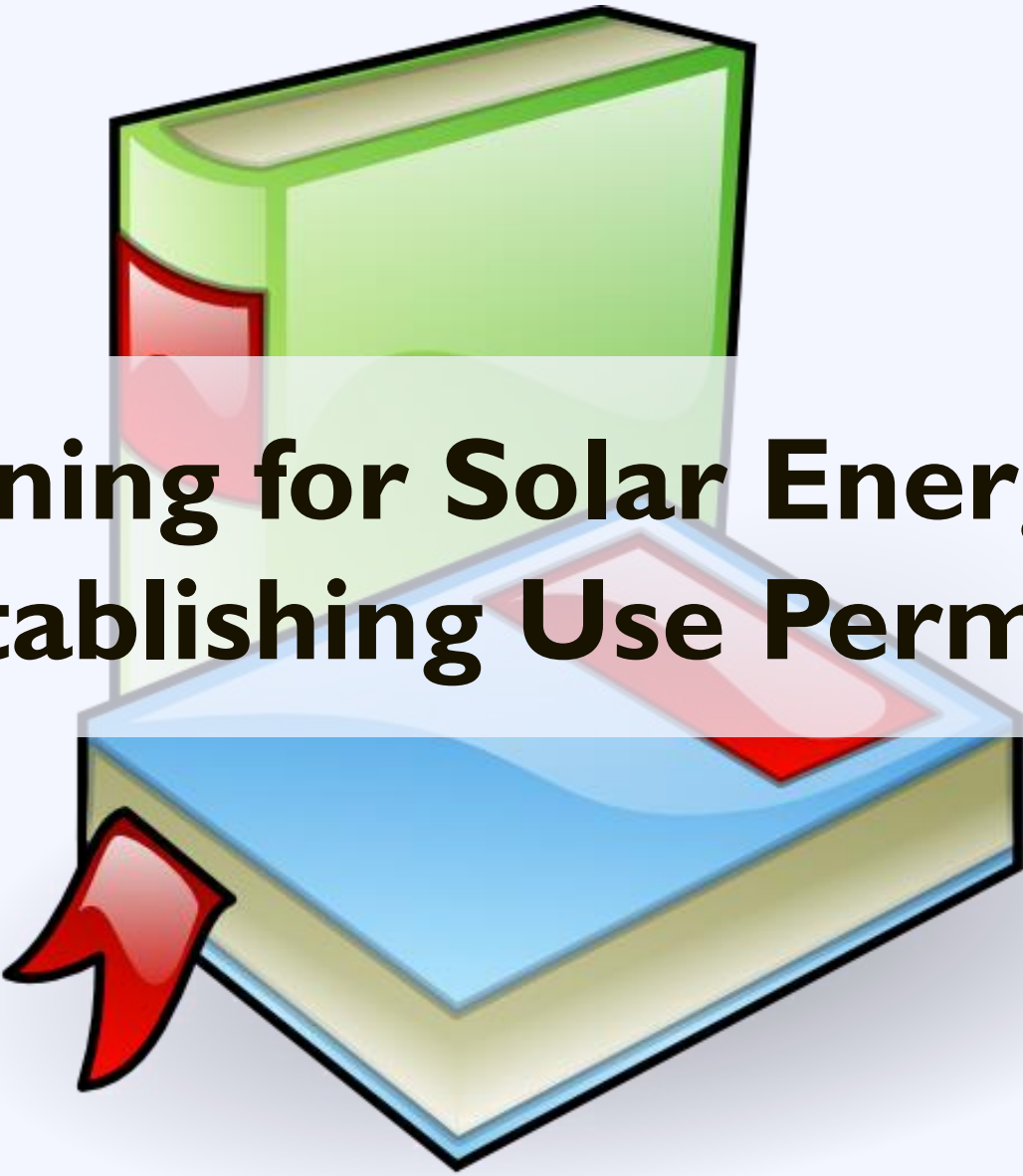

Zoning for Solar Energy Use: Establishing Use Permissions

Three Alternative Approaches

- Regulatory silence
- Permissions that distinguish between accessory and primary solar energy systems
- Permissions that distinguish among different types of solar energy systems

Regulatory Silence

Pros

- You don't have to do anything.

Cons

- Property owners and developers may not be mind readers.
- Relies on ad-hoc use interpretations and “tradition” for small solar energy systems.
- Relies on time-consuming (and costly) discretionary review processes for larger solar energy systems.

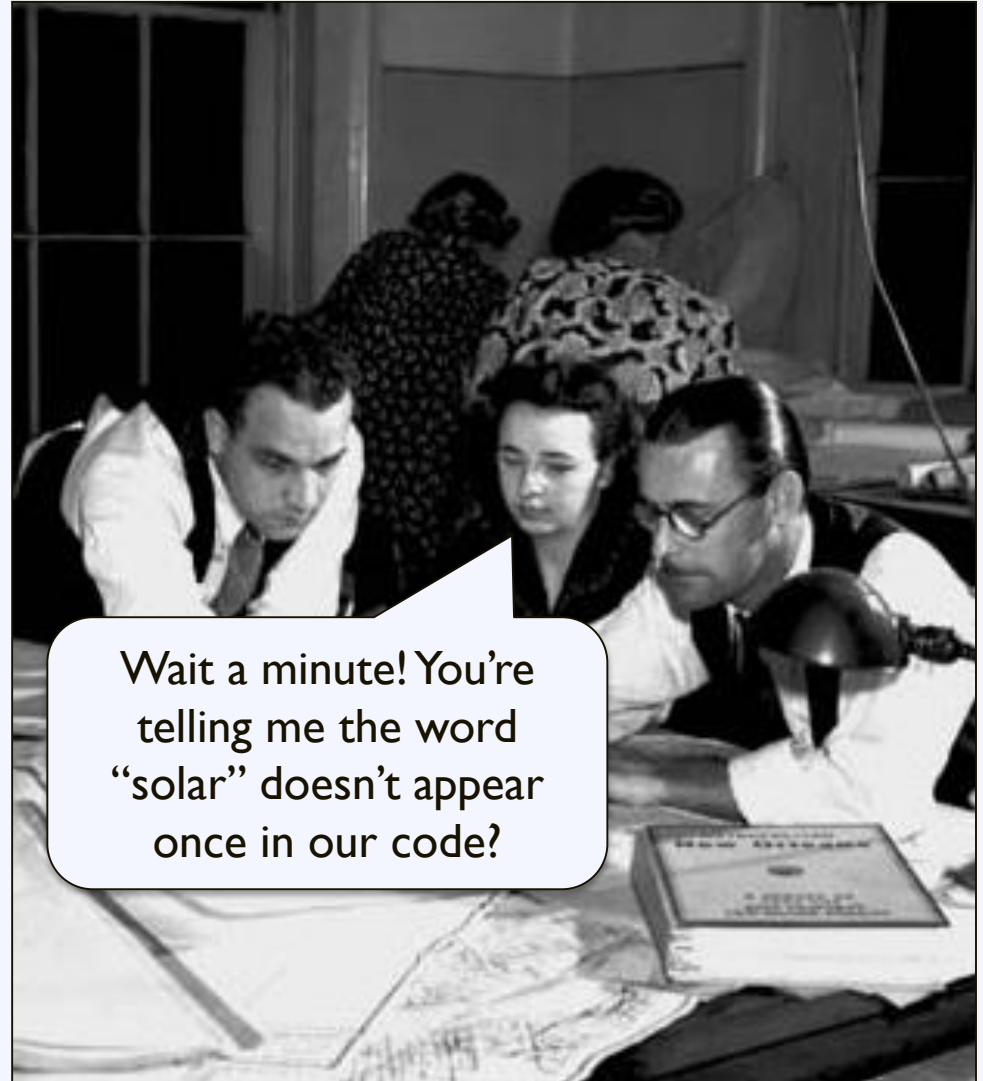

Accessory vs. Primary Distinctions

TABLE OF PERMITTED USES											
P = Permitted; C=Conditional Use; A=Accessory Use Only											
	Open Space Districts		Residential Districts		Mixed-Use Districts			Commercial Districts		Industrial Districts	
Use	OS	AG	R-1	R-2	MX-1	MX-2	CBD	NC	GC	LI	HI
solar energy system	C	A	A	A	A	A	A	A	A	C	P

Pros

- Consistent with how many communities add new uses to their codes.

Cons

- “Accessory” isn’t always easy to define.
- Has no inherent connection to land-use characteristics.
- All nuance must be handled through use-specific standards.

System Type Distinctions

TABLE OF PERMITTED USES

P = Permitted; C=Conditional Use; X=Prohibited

Use	Open Space Districts		Residential Districts		Mixed-Use Districts			Commercial Districts		Industrial Districts	
	OS	AG	R-1	R-2	MX-1	MX-2	CBD	NC	GC	LI	HI
building-integrated solar energy system	P	P	P	P	P	P	P	P	P	P	P
building-mounted solar energy system	P	P	P	P	P	P	P	P	P	P	P
small ground-mounted solar energy system	C	P	P	C	C	C	X	C	C	C	P
medium ground-mounted solar energy system	X	P	C	X	X	X	X	X	C	X	P
large ground-mounted solar energy system	X	C	X	X	X	X	X	X	X	X	P

System Type Distinctions

Pros

- Has inherent connection to land-use characteristics.
- Both clear and nuanced.

Cons

- Distinctions among small, medium, and large may feel arbitrary.





Zoning for Solar Energy Use: Adopting Appropriate Standards

Standards for Building-Mounted Systems

- Limited exemptions from district height limits
- Placement restrictions in historic districts
- Decommissioning requirements
- Aviation notification and glare analysis for systems over a certain size (e.g., 1/2 acre)



Standards for Ground-Mounted Systems

- Height limits and required setbacks
- Minimum lot size or maximum lot coverage
- Screening requirements
- Transmission infrastructure placement requirements
- Signage and lighting limits
- Decommissioning requirements
- Aviation notification and glare analysis for systems over a certain size (e.g., 1/2 acre)





Zoning for Solar Energy Use: Adopting Complimentary Development Regulations

Complimentary Regulations

- Solar access protections
- Solar site-design standards
- Solar-ready home standards
- Incentives for projects that incorporate solar energy systems

Solar Access Protections

- Three basic species of solar access protections:
 - Solar access easements
 - Solar access permits
 - Solar “fences”

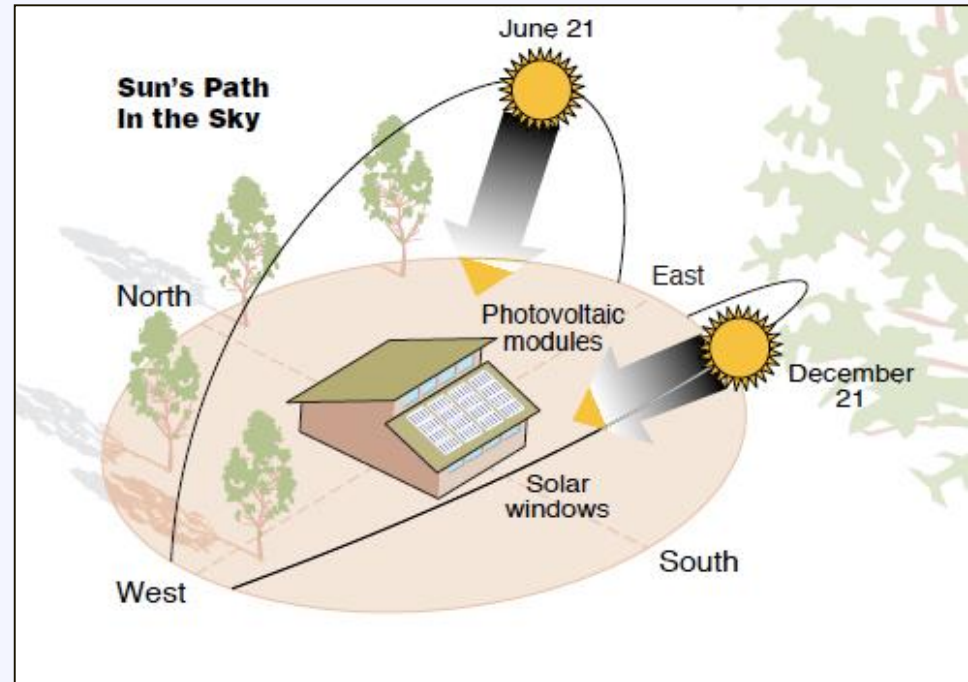

Solar Access Easements

- Over 30 states have statutorily enabled solar access easements (but not SC).
- These easements are private agreements that protect solar access on a particular property through limits on
 - building height
 - trees and other vegetation
- Typically voluntary but may be tied to permit process

Solar Access Permits

- Owner documents solar energy system to receive protection of solar access
- Limitations of shading on solar energy systems through limits on
 - Building height and massing
 - Tree and landscaping placement

Solar “Fence” Standards

- Unobstructed access to sunlight required for “box” on lot
- Limitations of shading on solar energy systems through limits on
 - Building height and massing
 - Tree and landscaping placement



House to be analyzed below

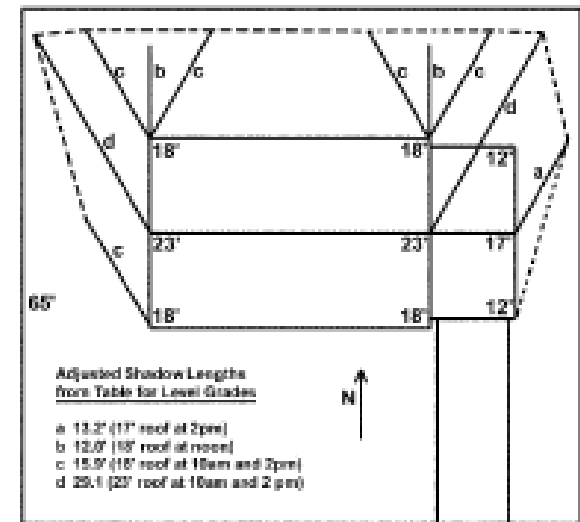

70' Property Line

Figure 1. Simplified Shadow Analysis for House in Solar Access Area 1 (Illustration only—not to scale)

Solar Site Design Standards

- Minimum number of lots must be “Solar-Oriented Lots”
- Streets designed to maximize solar access
- Buildings oriented for maximum solar gain
- Typically applied to low-density residential zones

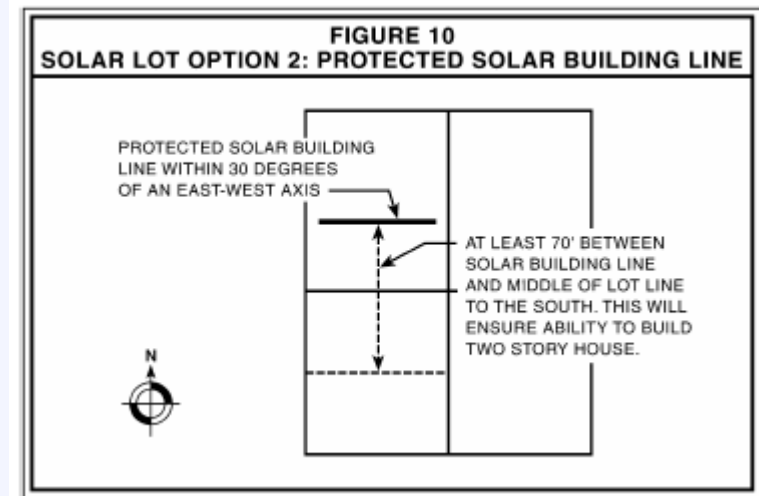
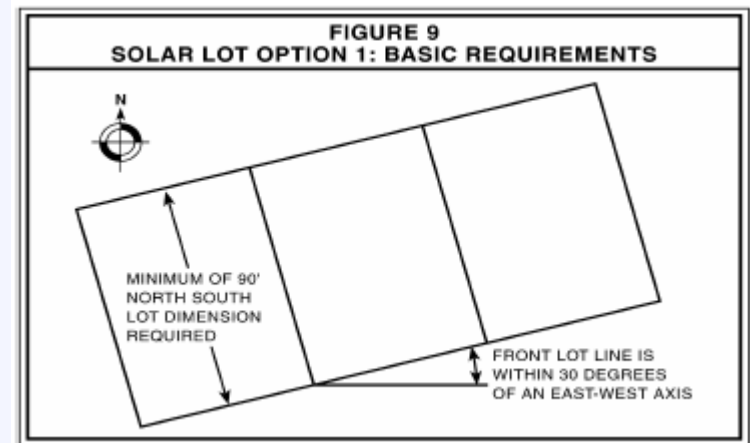

Source: www.clackamas.us

Solar-Ready Home Standards

- May be mandatory or voluntary
- Prewiring for solar PV systems
- Pre-plumbing for solar hot water systems



Development Incentives

- Density bonus for projects that incorporate solar energy systems
 - Bonus tied specifically to solar power
 - Bonus tied to a menu of potential features

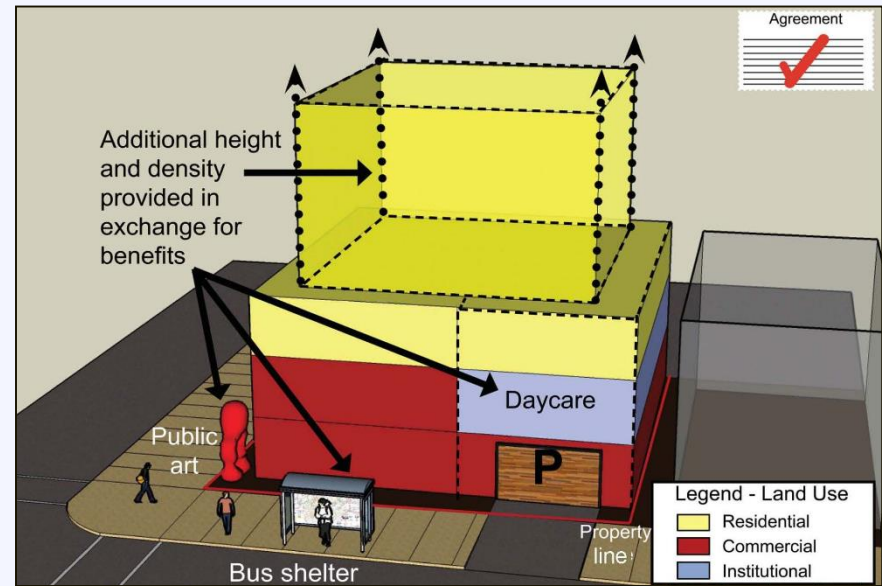

Model Solar Development Regulations

Source	Model Ordinances
Capitol Region Council of Governments [CT]	Sustainable Land Use Code Project Model Regulations: Alternative Energy; Sustainable Land Use Code Project Model Regulations: Solar Access
Massachusetts Executive Office of Energy and Environmental Affairs	Model Zoning for the Regulation of Solar Energy Systems ; Model As-of-Right Zoning Bylaw: Allowing Use of Large-Scale Ground-Mounted Solar Photovoltaic Installations
Minnesota Department of Commerce	Solar Energy Standards - Urban Communities; Solar Energy Standards - Counties
North Carolina Clean Energy Technology Center	Template Ordinance for Solar Energy Development in North Carolina
Utah Clean Energy	Model Ordinance for Residential and Non-Residential Distributed Solar Energy Systems



Powered by

SunShot

U.S. Department of Energy

David Morley, AICP

Senior Research Associate

American Planning Association

dmorley@planning.org

312.786.6392

Solar Outreach Partnership: solaroutreach.org

APA's SolarOPs resources: www.planning.org/research/solar/

Efficient Solar Permitting for Your Jurisdiction: South Carolina



Powered by

SunShot

U.S. Department of Energy

About the SunShot Solar Outreach Partnership



The SunShot Solar Outreach Partnership (SolarOPs) is a U.S. Department of Energy (DOE) program designed to increase the use and integration of solar energy in communities across the US.

About the SunShot Solar Outreach Partnership

Resource Sunshot Resource Center

- Case Studies
- Fact Sheets
- How-To Guides
- Model Ordinances
- Technical Reports
- Sample Government Docs

www4.eere.energy.gov/solar/sunshot/resource_center



The screenshot shows the SunShot Solar Energy Resource Center website. The page features a navigation menu with options like HOME, ABOUT, SOLAR PROGRAM, FINANCIAL OPPORTUNITIES, and INFORMATION RESOURCES. A search bar is visible. The main content area is titled "Solar Energy Resource Center" and includes a description of the center's mission and a list of resources. A sidebar on the left allows users to filter resources by Topic, Audience, Resource Type, and State. A map of the United States is displayed, showing the states of each resource. The page also includes a "FIND RESOURCES BY KEYWORD" search bar and a "FIND RESOURCES BY STATE" section.

About IREC

For 30 years the Interstate Renewable Energy Council, Inc. (IREC) has been known for connecting people, ideas and technology to produce measurable results in the renewable energy field.

IREC's programs and policies lead to:

- easier, more affordable **connection to the utility grid**;
- **fair credit** for renewable energy produced;
- **best practices** for states, municipalities, utilities, and industry; and
- **quality assessment and credentialing** for trainers of our growing clean energy workforce.

Permitting Umbrella



Sharing Success

Emerging Approaches
to Efficient Rooftop
Solar Permitting



www.irecusa.org

May 2012

Interstate Renewable Energy Council, Inc.

Agenda

- 11:30 – 11:45 Identifying Goals: Why permitting reform?
- 11:45 – 12:45 Identifying Successful Approaches Part I:
Pre-application and application submittal
- 12:45 – 1:15 *Lunch*
- 1:15 – 2:15 Identifying Successful Approaches Part II:
Application review and inspections
- 2:15 – 2:45 Regional Coordination: Examples & Discussion
- 2:45 – 3:00 Wrap-up

Identifying Goals: Why Permitting Reform?

U.S. Solar Projections to 2020 (GW)

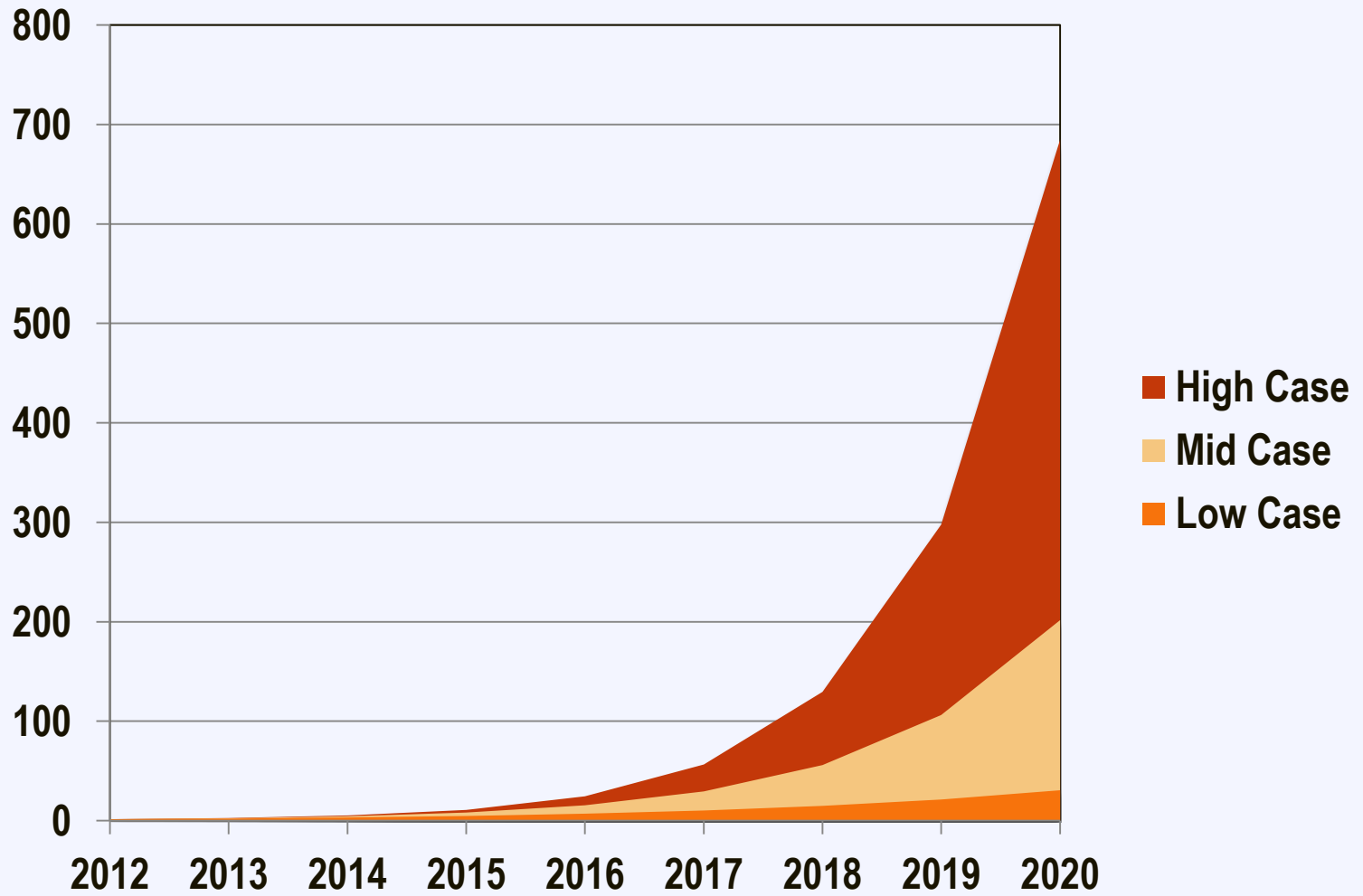

Identifying Challenges

Solar Developer Perspective:

- Unclear or inconsistent requirements
- Lengthy application review process, even for small projects
- High or inconsistent fees
- Multiple inspections and long time windows
- Lack of familiarity with solar

Added together, these cost a lot of money!

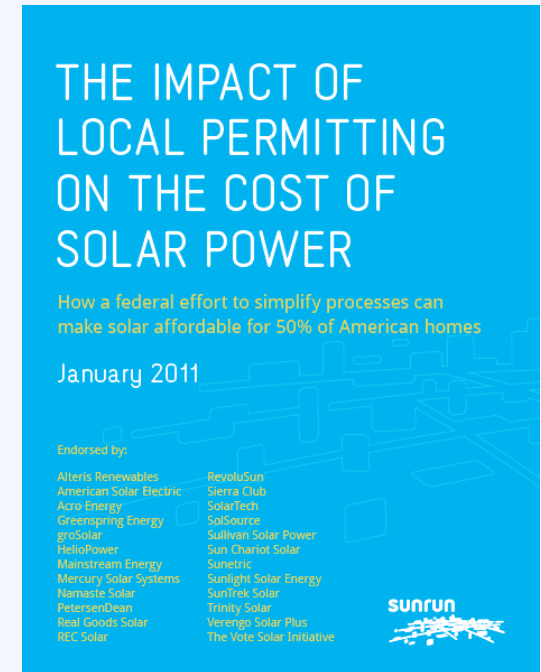

Identifying Challenges

Local Government Perspective:

- Solar permitting is just a piece of everything else local governments do
- Many local governments are resource-constrained
- Inexperienced installers submit incomplete applications
- Installations do not match design drawings
- Importance of balancing government's needs and demands with encouraging solar energy and economic development



Residential Solar “Soft Costs”

U.S. Average Total Soft Costs, by System Size and Type

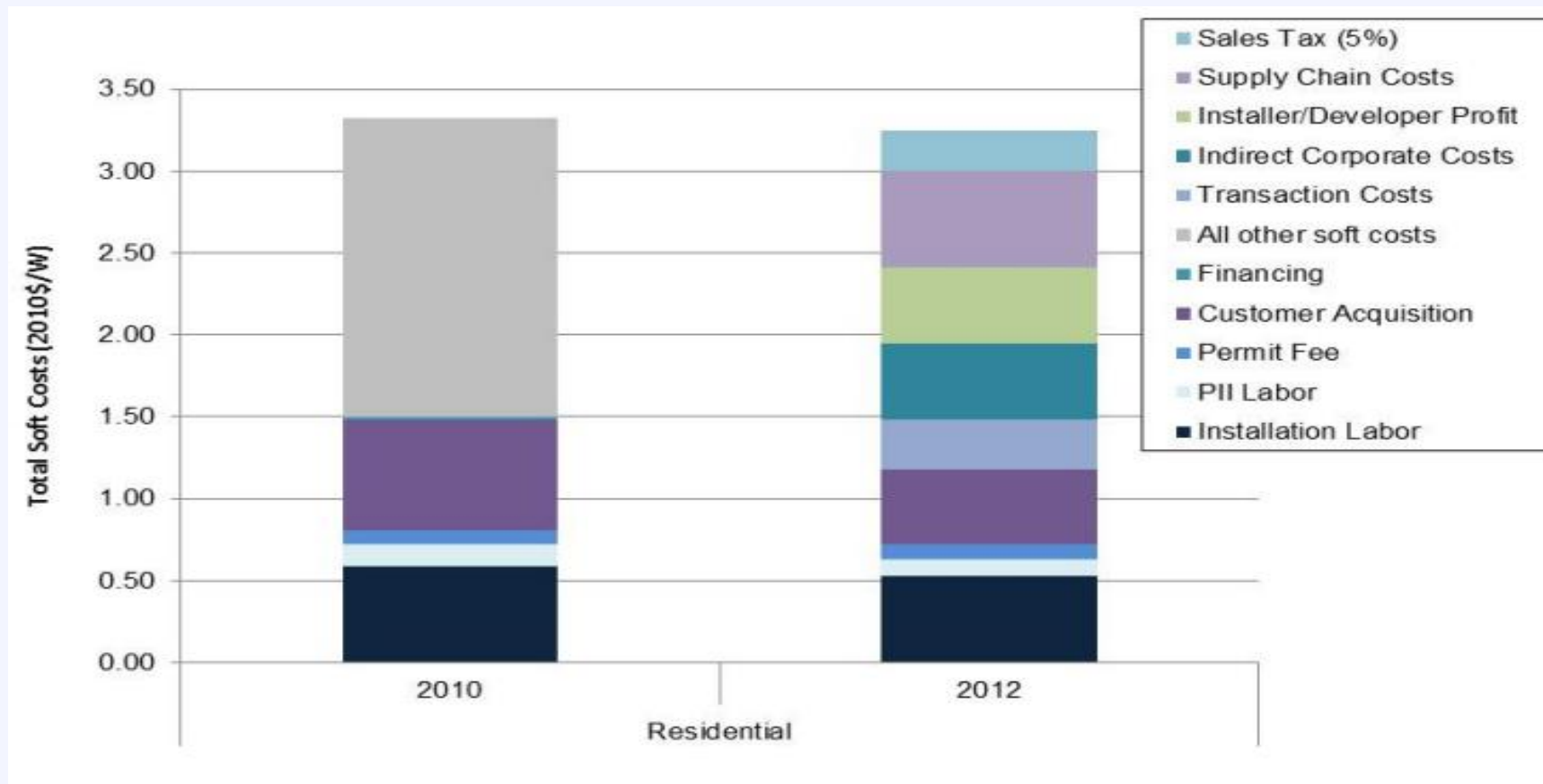

U.S. Total Costs (2012)
Weighted avg. for res. PV (<10 kW) = \$5.04/Watt

Small Commercial Solar “Soft Costs”

U.S. Average Total Soft Costs, by System Size and Type

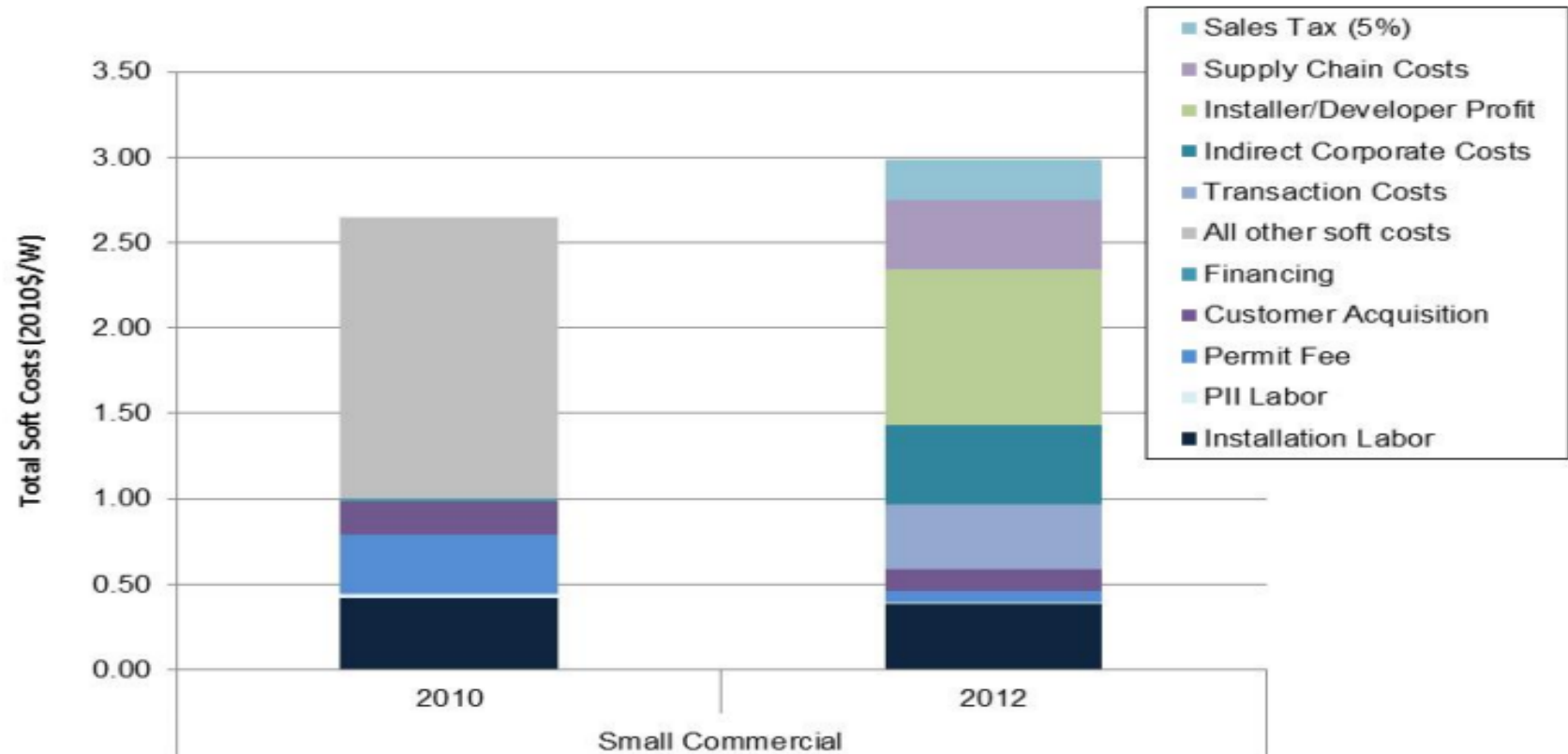

U.S. Total Costs (2012)
Weighted avg. for comm. PV (>100 kW) = \$4.27/Watt

Permitting Costs Matter

- Local permitting and inspection add an average of about \$0.50 per watt, or \$2,516 per residential install
- Inefficient processes can overwhelm local departments and consume resources that could be used elsewhere
- An efficient process can promote economic development and energy savings in the community

Activity: Getting to know you

1. Name
2. Municipality or Jurisdiction & position
3. What is the interest level of solar development in your jurisdiction and how does it impact you or your department?

Implementing Improvements: Key Principles

- **Responsibility** for change should be shared between permitting authorities and the solar industry.
- Changes to permitting policies should **benefit** municipal governments as well as solar installers and their customers.

Goals for Permitting Reform

1. Post requirements online
2. Implement an expedited permit process
3. Enable online permit processing
4. Require a fast turn-around time
5. Implement reasonable permitting fees

Goals for Permitting Reform

6. Do not require community-specific licenses
7. Offer a narrow inspection appointment window
8. Eliminate excessive inspections
9. Train permitting staff in solar

PLUS regional consistency

Vote Solar/IREC Permitting Best Practices www.irecusa.org/wp-content/uploads/2013/08/Solar-Permitting-Best-Practices_July2013_revisedC.pdf

IREC Best Practices Explained www.irecusa.org/wp-content/uploads/2013/09/expanded-best-practices.pdf

IREC Importance of Consistency www.irecusa.org/wp-content/uploads/2013/08/Permitting-Consistency.pdf

Identifying Successful Approaches

Overview of the Permitting Process

Pre-Application – access to information on solar permit requirements and procedures



Application Submittal and Review – application forms, fees and review



Inspections – scheduling inspections and inspector training

Pre-Application Materials:

How they can help

- Reduce number of individualized questions staff has to field
- Increase amount of applications submitted correctly and completely the first time
- Put everyone on the same page with respect to requirements—reducing conflict
- Can help manage expectations
- Facilitate solar expansion in your community

Poll

Does your jurisdiction provide any pre-application materials?

A. Yes

B. No

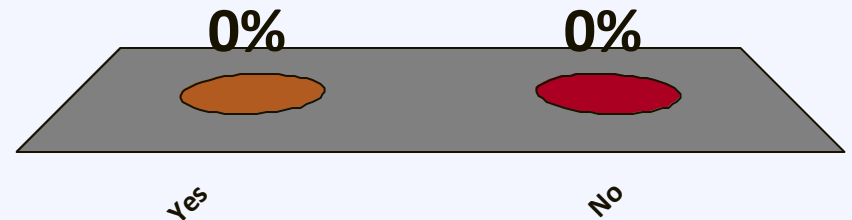

Application Checklists

Just the Basics

Solar Permitting Checklists

Checklists are an integral part of the permitting process. They provide a simple list of required information for either the permit application or the inspection that follows. As such, they can serve as guides for solar installers as well as permit review staff and inspectors. Checklists can save staff time for the jurisdiction by reducing the number of inquiries received from installers, and can also save time and money for the solar installer by making requirements clear and transparent. They can also help to ensure that application and inspection requirements are applied consistently across the board to all installers. In some cases, jurisdictions require applicants to turn in the completed checklist as part of the application to help to verify that the application is complete. Some jurisdictions choose to provide even more information in other guidance documents, as discussed on the reverse side of this sheet.

Tips for Application Checklists

- ✓ List required forms, such as building permit application form, and where they can be located
- ✓ List and describe required diagrams or plans, including the number of copies needed
- ✓ List any other required documentation, signatures or approvals
- ✓ Describe the fee structure and options for payment
- ✓ Provide online or in-person application submittal instructions
- ✓ Provide information about office locations, hours, and appropriate staff contacts
- ✓ Include citations to relevant code or other sources as much as possible for the applicant to reference

Tips for Inspection Checklists

- ✓ List the information required in advance of the inspection
- ✓ List what the inspector will look at on-site and what requirements are expected to be met
- ✓ Consider dividing checklist into appropriate sections, such as utility service/AC power source, inverter, arrays/modules, and grounding/bonding
- ✓ Explain who needs to be there and what applicant can expect during the inspection
- ✓ Provide information about office locations, hours, and appropriate staff contacts
- ✓ Include citations to relevant code or other sources as much as possible for the applicant to reference

Examples to check out

These jurisdictions have published checklists for solar permitting:

- Boulder County, Colorado
- San Jose, California
- Miami-Dade County, Florida
- Berkeley, California
- Tucson, Arizona
- Maui County, Hawaii



For more examples and discussion of permitting checklists and other guidance documents, see IREC's report, *Sharing Success: Emerging Approaches to Efficient Rooftop Solar Permitting*, available at: www.irecusa.org/wp-content/uploads/FINAL-Sharing-Success-w-cover-revised-final052012.pdf.

- List required forms, diagrams or plans and where they can be found
- List any other documentation, signatures or approvals
- Describe the fee structure and options for payment
- Provide submittal instructions
- Provide office locations, hours and appropriate staff contacts
- Include citations to relevant code or other references for technical requirements

Solar Permit Guidebooks

Going Above and Beyond Solar Permitting Guidance Documents

Checklists provide the essential information on the permit application and inspection process, and are a great place to start. But sometimes it can be even better to provide more detailed information to solar permitting applicants in more comprehensive guidance documents. In addition to information on permit application and processing, these documents may provide background on solar technologies, available incentives, information on finding installers, roles for different departments and entities in facilitating a solar installation, and more. At a minimum, guidance documents should include information about your jurisdiction's processes, including any unique or unusual requirements. All of the information for checklists described on the reverse side of this sheet would be appropriate for guidance documents, as well. Beyond that, there are a variety of topics jurisdictions have included in guidance documents.



Tips for Writing

- ✓ Work with nearby communities to streamline procedures and forms and to share the task of creating them.
- ✓ Try to coordinate with other relevant agencies, departments and entities, such as the local utility, to offer guidance that is as comprehensive as possible.
- ✓ Approach the document from an outsider's perspective: what information would a complete novice need to successfully complete the process?
- ✓ Review existing guidance documents from other jurisdictions. The following cities provide good examples: Portland, OR; Philadelphia, PA; San Diego, CA; San Jose, CA; Boston, MA and Scottsdale, AZ.
- ✓ Solicit feedback from a wide audience, including developers, homeowners and fellow staff.

Topics for Consideration

1. Solar Installation Process Overview
2. Licensing and Code Requirements
3. The Interconnection Process
4. Electrical Permit Requirements
5. Building Permit Requirements
6. System Inspection Process
7. Information on Incentives
8. Definitions of Uncommon Terms and Acronyms

★ Gold Star for Good Work Solar Permitting Guidance in Boston, MA

The City of Boston offers one of the most thorough solar permitting guides in the United States. Its "Solar Boston Permitting Guide" was developed as part of the City's involvement in the U.S. DOE's Solar America Cities program. The Guide serves as a resource for Boston residents, businesses and solar installers to help them navigate the solar development process.

Boston also provides an interactive GIS map to help assess locations for solar on the same web site. Even for jurisdictions not interested in going as far as Boston, its permitting guidance materials offer a great model to start from. This guide is available at www.cityofboston.gov/climate/solar.asp.

A broader look at the solar permitting process

- Installation process overview
- Licensing and code requirements
- Interconnection process
- Electrical permit requirements
- Building permit requirements
- System inspection process
- Information on incentives
- Definitions of uncommon terms and acronyms

Poll

**Does your jurisdiction
have a website?**

A. Yes

B. No

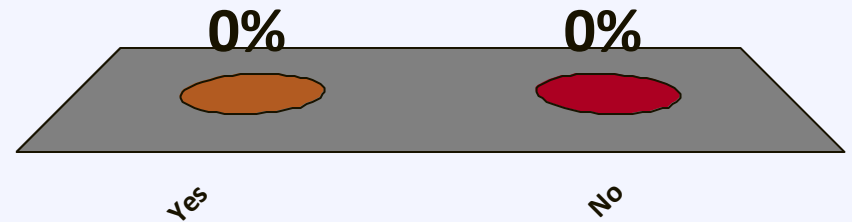

Poll

Does it have a page for your department?

A. Yes

B. No

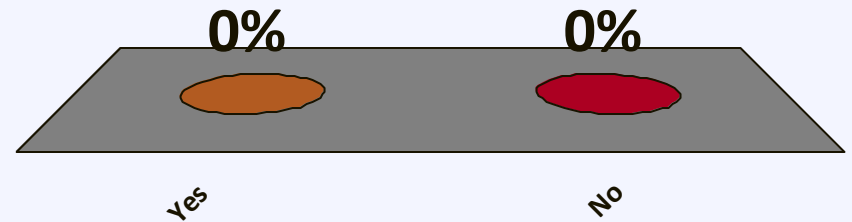

Poll

Does it have a solar-specific page?

A. Yes

B. No

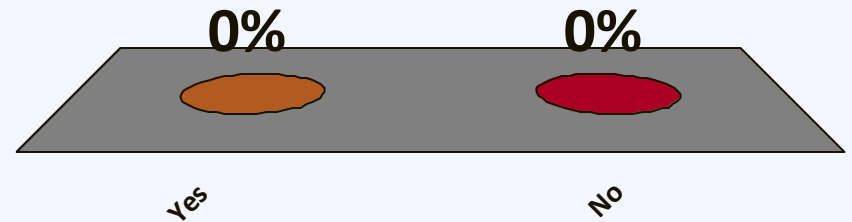

Website and Electronic Resources

- Permitting requirements applicable to solar
- Application form and any checklists
- Detail on how the application will be processed
- Links to other regulatory or private entities involved in solar permitting
- Links to additional information and resources



Solar Permit Application Form

Clear identification of the precise information needed to process a permit for a solar installation

Consistent to the extent possible across jurisdictions in a region or state

EXPEDITED PERMIT PROCESS FOR PV SYSTEMS

The information in this guideline is intended to help local jurisdictions and contractors identify when PV system installations are simple, needing only a basic review, and when an installation is more complex. It is likely that 50%-75% of all residential systems will comply with these simple criteria. For projects that fail to meet the simple criteria, resolution steps have been suggested to provide as a path to permit approval.

Required Information for Permit:

1. Site plan showing location of major components on the property. This drawing need not be exactly to scale, but it should represent relative location of components at site (see supplied example site plan). PV arrays on dwellings with a 3' perimeter space at ridge and sides may not need separate fire service review.
2. Electrical diagram showing PV array configuration, wiring system, overcurrent protection, inverter, disconnects, required signs, and ac connection to building (see supplied standard electrical diagram).
3. Specification sheets and installation manuals (if available) for all manufactured components including, but not limited to, PV modules, inverter(s), combiner box, disconnects, and mounting system.

Step 1: Structural Review of PV Array Mounting System

Is the array to be mounted on a defined, permitted roof structure? Yes No

If No due to non-compliant roof or a ground mount, submit completed worksheet for the structure WKS1.

Roof Information:

1. Is the roofing type lightweight (Yes = composition, lightweight masonry, metal, etc...) _____
If No, submit completed worksheet for roof structure WKS1 (No = heavy masonry, slate, etc...).
2. Does the roof have a single roof covering? Yes No
If No, submit completed worksheet for roof structure WKS1.
3. Provide method and type of weatherproofing roof penetrations (e.g. flashing, caulks) _____

Mounting System Information:

1. Is the mounting structure an engineered product designed to mount PV modules? Yes No
If No, provide details of structural attachment certified by a design professional.
2. For manufactured mounting systems, fill out information on the mounting system below:
 - a. Mounting System Manufacturer _____ Product Name and Model# _____
 - b. Total Weight of PV Modules and Rails _____ lbs
 - c. Total Number of Attachment Points _____
 - d. Weight per Attachment Point (b + c) _____ lbs (if greater than 45 lbs, see WKS1)
 - e. Maximum Spacing Between Attachment Points on a Rail _____ inches (see product manual for maximum spacing allowed based on maximum design wind speed)
 - f. Total Surface Area of PV Modules (square feet) _____ ft²
 - g. Distributed Weight of PV Module on Roof (b + f) _____ lbs/ft²
If distributed weight of the PV system is greater than 5 lbs/ft², see WKS1.

Step 2: Electrical Review of PV System (Calculations for Electrical Diagram)

In order for a PV system to be considered for an expedited permit process, the following must apply:

1. PV modules, utility-interactive inverters, and combiner boxes are identified for use in PV systems.
2. The PV array is composed of 4 series strings or less per inverter, and 15 kWSTC or less.
3. The total inverter capacity has a continuous ac power output 13,440 Watts or less
4. The ac interconnection point is on the load side of service disconnecting means (690.64(B)).
5. The electrical diagram (E1.1) can be used to accurately represent the PV system.

Fill out the standard electrical diagram completely. A guide to the electrical diagram is provided to help the applicant understand each blank to fill in. If the electrical system is more complex than the standard electrical diagram can effectively communicate, provide an alternative diagram with appropriate detail.

Model: Solar ABCs *Expedited Permit Process for PV*

Poll

Does your jurisdiction determine the residential permit fee for solar based on:

- A. Valuation
- B. Flat Fee
- C. Other?

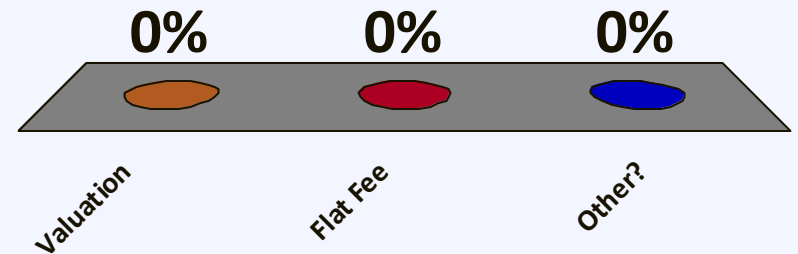

Solar Permit Fees

Fees should be based upon staff time it takes to process solar permit application

- The Vote Solar Initiative, Project: Permit—community-led fee-reduction campaign

www.projectpermit.org

- Fee Calculator

http://lomaprieta.sierraclub.org/climate-action/solar_permit_fees

- State fee statutes

– Examples: California, Colorado, Arizona

- Fee waivers—City and County of Honolulu

LUNCH

Poll

**Do you offer in-person
submittal with later
review for all
applications?**

A. Yes

B. No

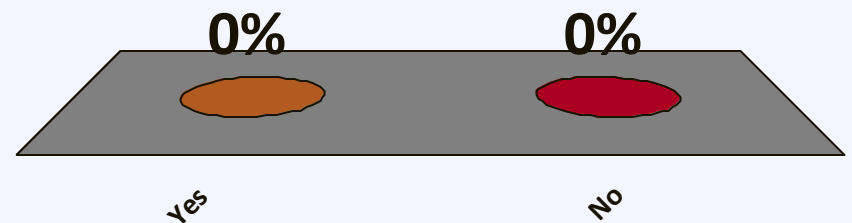

Poll

Do you have an expedited process for certain permits?

- A. Yes
- B. No

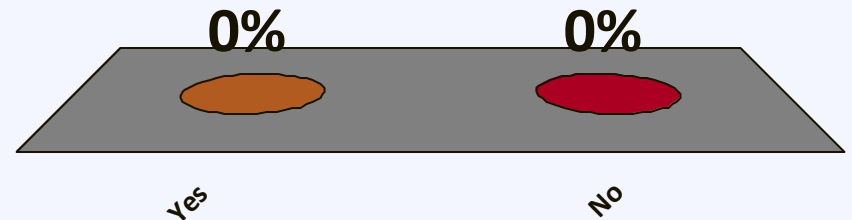

Poll

Do you offer online permitting?

A. Yes

B. No

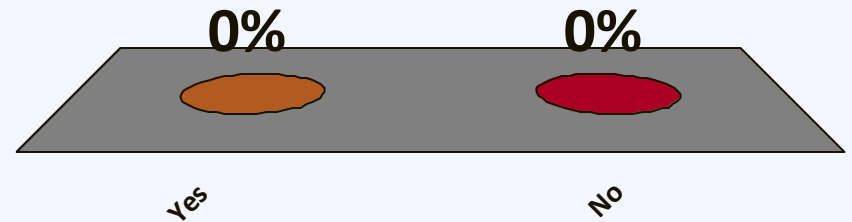

Poll

How long would you expect it to take to process a residential solar permit application?

- A. Same day
- B. Less than 3 days
- C. More than 3 days
- D. A week or more

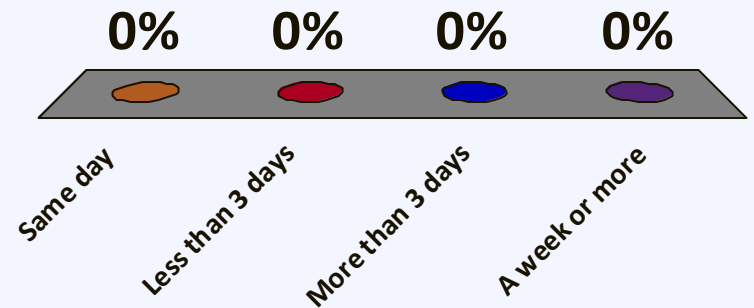

Application Submittal and Review

- Most common process = in-person submittal with later review

Potential Improvement: Expedited review for pre-qualified projects, plans or installers

- Simple project pre-qualification
 - Solar ABCs model
- Plan templates or pre-approvals
 - Honolulu, HI (pre-approved templates)
 - San Diego, CA (pre-approved plan)
- Installer pre-qualification
 - Long Island Unified Solar Permitting Initiative (NY)

Common Project Requirements for Expedited Review

- Rooftop installations on residential structures
- Size limited (often to 10 kW or below)
- A maximum weight per sq. ft., e.g., 5 lbs/sq. ft.
- Minimum clearance range around the equipment
- Maximum height above the roof surface
- Panels and inverters installed per manufacturers' specifications

Application Submittal and Review

Potential Improvement: Over-the-counter submittal and review for qualified systems

- Goal = one trip, short wait time
- Often more efficient for city and applicant
- Can be limited to “simple systems” that meet pre-identified goals
- Goal = one trip, short wait time
- Example: Scottsdale, AZ—for all residential plan review, including solar

Application Submittal and Review

Potential Improvement: Online or electronic submittal and review

- Potential to be significantly more efficient for city and applicant
- Online applications can present education opportunity and increase completeness
- Can improve communication opportunities
- However, can present high upfront costs
- Can be rolled out slowly in small steps

Application Submittal and Review

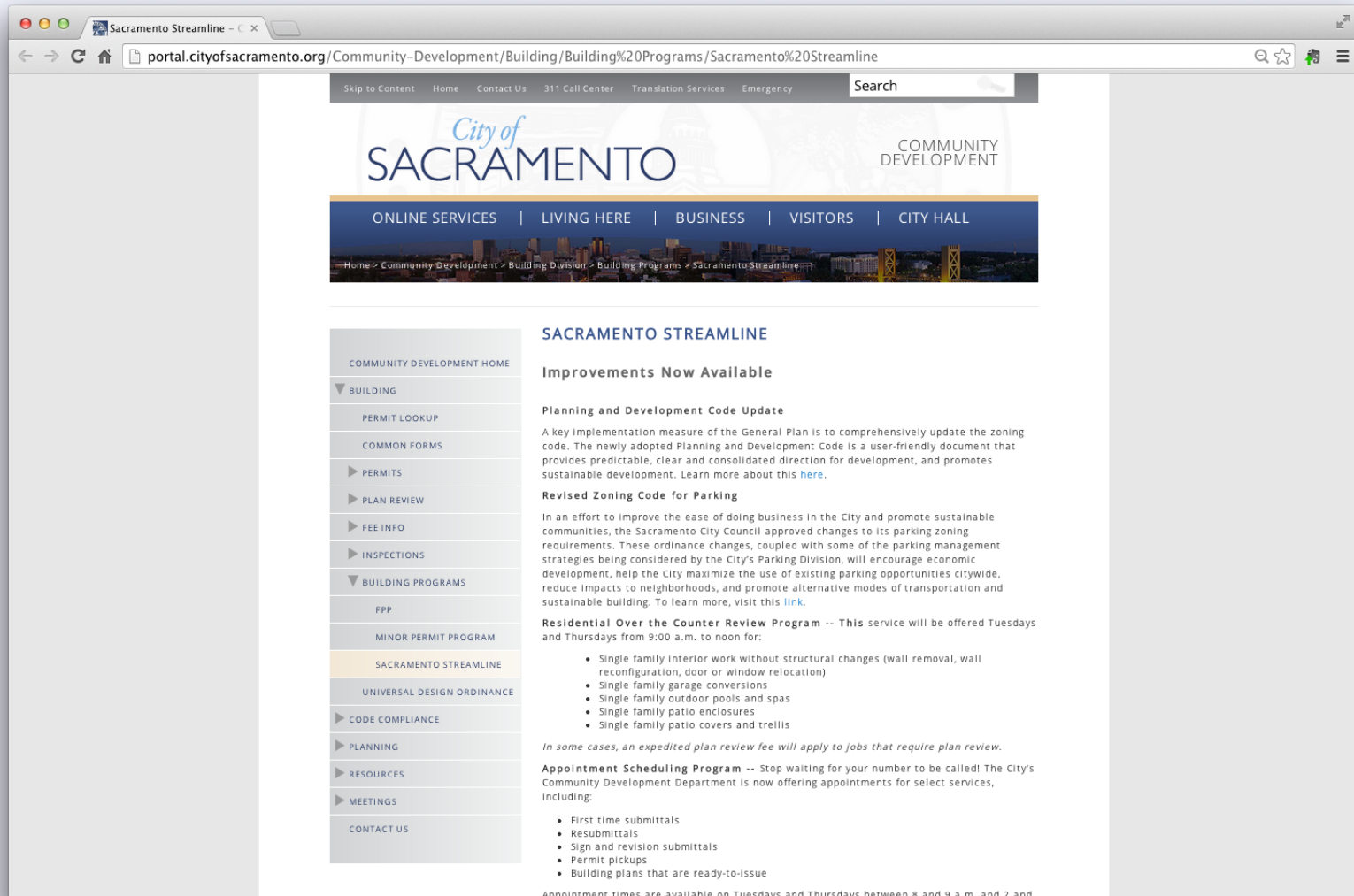

The screenshot shows a web browser window displaying the Sacramento Streamline website. The URL in the address bar is portal.cityofsacramento.org/Community-Development/Building/Building%20Programs/Sacramento%20Streamline. The page features a navigation menu with links for Skip to Content, Home, Contact Us, 311 Call Center, Translation Services, and Emergency. The main header includes the City of Sacramento logo and the text "COMMUNITY DEVELOPMENT". Below the header is a navigation bar with links for ONLINE SERVICES, LIVING HERE, BUSINESS, VISITORS, and CITY HALL. The breadcrumb trail reads: Home > Community Development > Building Division > Building Programs > Sacramento Streamline.

The main content area is titled "SACRAMENTO STREAMLINE" and features a section for "Improvements Now Available". This section includes three sub-sections:

- Planning and Development Code Update**: A key implementation measure of the General Plan is to comprehensively update the zoning code. The newly adopted Planning and Development Code is a user-friendly document that provides predictable, clear and consolidated direction for development, and promotes sustainable development. Learn more about this [here](#).
- Revised Zoning Code for Parking**: In an effort to improve the ease of doing business in the City and promote sustainable communities, the Sacramento City Council approved changes to its parking zoning requirements. These ordinance changes, coupled with some of the parking management strategies being considered by the City's Parking Division, will encourage economic development, help the City maximize the use of existing parking opportunities citywide, reduce impacts to neighborhoods, and promote alternative modes of transportation and sustainable building. To learn more, visit this [link](#).
- Residential Over the Counter Review Program** -- This service will be offered Tuesdays and Thursdays from 9:00 a.m. to noon for:
 - Single family interior work without structural changes (wall removal, wall reconfiguration, door or window relocation)
 - Single family garage conversions
 - Single family outdoor pools and spas
 - Single family patio enclosures
 - Single family patio covers and trellis

In some cases, an expedited plan review fee will apply to jobs that require plan review.

Appointment Scheduling Program -- Stop waiting for your number to be called! The City's Community Development Department is now offering appointments for select services, including:

- First time submittals
- Resubmittals
- Sign and revision submittals
- Permit pickups
- Building plans that are ready-to-issue

Appointment times are available on Tuesdays and Thursdays between 8 and 9 a.m. and 2 and 3 p.m.

Poll

Do you require a rough-in and final inspection for residential solar?

- A. Yes
- B. No

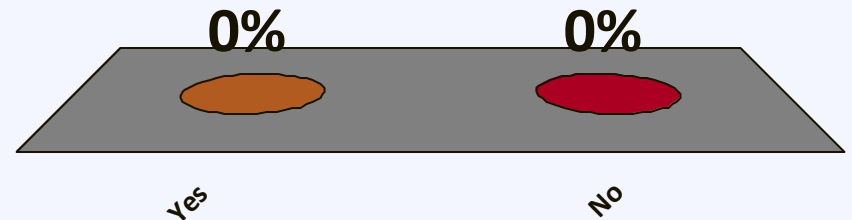

Poll

**Do you require
different inspections
for electrical,
building and/or fire?**

- A. Yes
- B. No

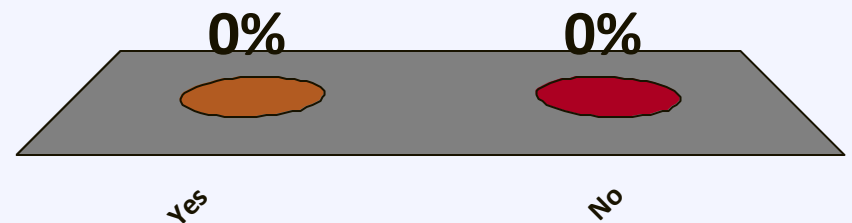

Inspection Timing and Scheduling

Frequency and timing of inspections = critical cost component of solar installation

Potential improvements:

- Easier inspection scheduling
- Reasonably narrow time window
- One inspection (building, electrical, fire, etc.)

Example: Miami-Dade County, Florida

Inspection Checklists & Guidelines

To inform and educate inspectors and installers—increase efficiency, minimize disputes

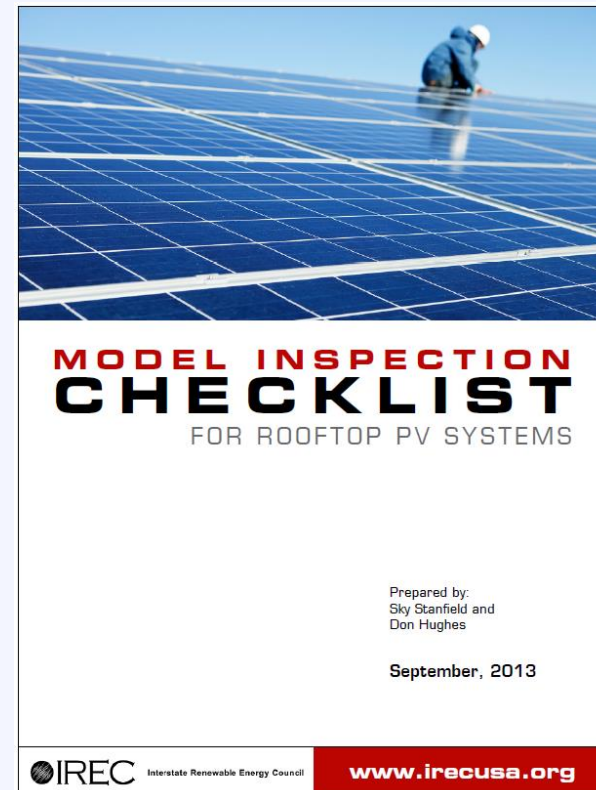
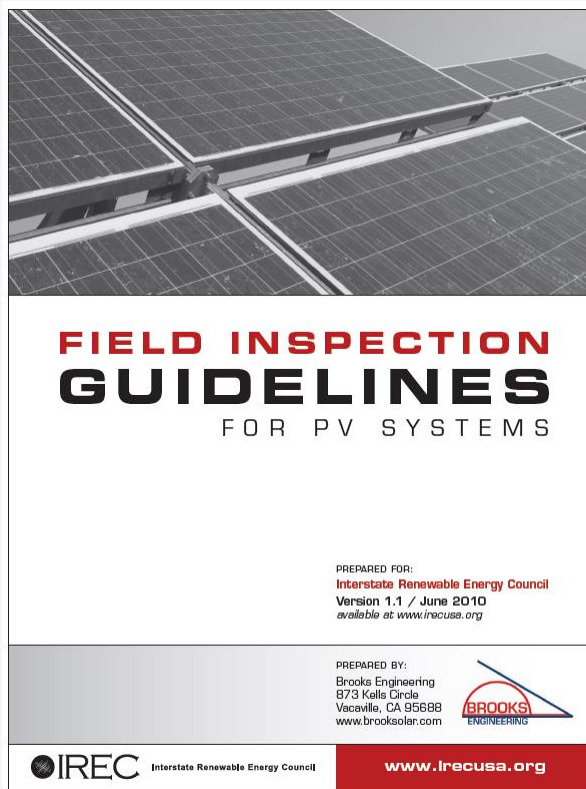

IREC Model Inspection Checklist

- Prepared in conjunction with Don Hughes, Senior Electrical Inspector in Santa Clara County, CA
- Contains key building, electric and fire code requirements with references to national code sections
- Includes a table of signage requirements
- Can easily be modified to include any unique state or local requirements.

Using an Inspection Checklist

- Educational tool for inspectors and installers
- Improve consistency of inspections – ensuring same features are checked for each system
- Reduce conflicts between inspectors and installers
- Method of notifying installers of unique or new requirements
- Can require it be submitted along with the application form

Inspector Training

Regional Training Providers



Photovoltaic Online Training Platform (PVOT)

- No-cost online training for code officials, architects, installers, etc.
- Three goals:
 1. Instruct code officials in reliable field inspection practices for PV installations
 2. Substantially increase reach and scale of training for code officials in the U.S.
 3. Quickly and cost-effectively reach more code officials than with onsite workshops and seminars
- Six basic learning modules covering the major topics of concern for expedited permitting and field inspection
- Seventh module is immersive activity imbedded in an open-source, game-based framework with its own assessment
- www.irecusa.org/workforce-education/solar-instructor-training-network/trainer-resources/pv-online-training

Installer Licenses

- Best Practice is to avoid community specific licenses.
- State contractors license
- Local business license or permit
- If license is required, use NABCEP or engage at the state level to develop a state-wide license

Regional Coordination: Examples & Discussion

Consistency Is Important

Simplifying the Solar Permitting Process The Importance of Consistency

Many municipalities and other authorities having jurisdiction (AHJs) are facing dramatic increases in rooftop solar permit applications. With this trend expected to continue and spread, streamlining building and electrical permitting processes will become increasingly important to more AHJs. To facilitate such streamlining, IREC and Vote Solar have identified nine [Best Practices in Residential Solar Permitting](#), which should result in benefits to both AHJs and solar installers.

Underlying these best practices is the goal of increased consistency of solar permitting processes across jurisdictions. When technical and procedural requirements are relatively consistent—regionally, statewide, or even nationally—it can offer significant efficiency benefits for both AHJs and the solar industry.

Why Is Consistency Important?

Like many other contractors, solar installers typically work in more than one jurisdiction. Their businesses may be countywide or statewide, or even span multiple states. On the other hand, control over the permitting process is typically a local function. AHJs have varying degrees of discretion over what the process looks like, but they are almost always the entities responsible for solar permitting. As a result, solar installers can often face different permitting requirements jurisdiction by jurisdiction. When permitting requirements vary in this way, understanding and complying with them can be time-intensive and costly for solar installers. It can also mean that installers make more mistakes in the process—for example, providing inadequate information on their applications—which in turn can be time-intensive and costly for AHJ staff, as well.

When requirements are consistent, installers become familiar with them and learn efficient ways to comply with them. Installers benefit because they spend less time learning the particularities of each jurisdiction's requirements and can instead focus on designing safe and effective systems that can be installed at a low cost. AHJs benefit because the overall quality of the applications and the installations increases. As a result, AHJ staff has to spend less time educating installers and ensuring compliance with relevant standards. Adoption of a consistent set of requirements also allows AHJs to take advantage of other jurisdictions' knowledge and experience, rather than developing new standards.



In the end, the core goal of any permitting process is to allow the AHJ to ensure public health and safety, as well as compliance with any design standards. Streamlining permitting processes in a consistent way does not change these goals. Instead, it helps to meet them in a more efficient manner for both AHJs and solar installers, as well as other contractors that obtain permits through the same processes.

- Standardization across a geographical region
 - Easier for installers working regionally or statewide
 - Easier for jurisdictions because installers make fewer mistakes
- Leveraging experience and successes of others
- Encouraging regional economic development

How to Work Toward Consistency

- **Local**—Adopt model forms and guidelines
- **Statewide**—Conform with state legislation and guidance
- **Regional**—Collaborate with neighboring jurisdictions

... Or do all three!

Model Forms and Guidelines

- IREC: Permitting www.irecusa.org/regulatory-reform/permitting
 - ★ Model Inspection Checklist for Rooftop PV Systems—can be tailored to meet local needs
 - Plus examples from other (nearby) jurisdictions included in:
 - *Sharing Success: Emerging Approaches to Efficient Rooftop Solar PV Permitting*
 - Residential Solar Permitting Best Practices Explained
 - Guide to Preparing Solar Permitting Checklists
- ★ Solar ABCs Expedited Permit Process
www.solarabcs.org/permitting

State Guidance and Legislation

- State-level guidance
 - Information on ways to streamline the process
 - Model forms and documents applicable statewide
 - Example: California Solar Permitting Guidebook
http://opr.ca.gov/s_renewableenergy.php
- State legislative efforts
 - Mandatory changes to make local processes more fair, efficient and uniform
 - Examples:
 - Permit fee statutes in CA, CO and AZ
 - More comprehensive statutes in CA and WA

Regional Approaches to Reform

- **Benefits**

- Cost-efficient—administrative economies of scale and sharing expertise
- Can reflect unique local/regional needs
- Can leverage existing partnerships
- Voluntary process—potentially more collaborative and consensus-based

- **However**—since voluntary and not mandatory, means some work to ensure meaningful regional buy-in

Poll

Do you stay in touch with other jurisdictions regarding permitting?

- A. Often
- B. Occasionally
- C. Never

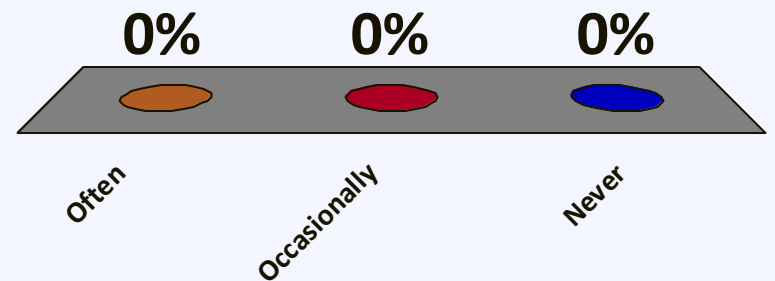

Regional Approaches to Reform

Solar One Stop (AZ)

<http://solaronestopaz.org>

- Collaborative web site housing wealth of solar-related information
- Explains coordinated regional permitting process in City of Tucson, Pima County and other area jurisdictions
 - Standardized process to simplify structural and electrical review of residential PV systems
 - 10-day standard turn-around time

Regional Approaches to Reform

East Bay Green Corridor Rapid PV Permit (CA)

www.ebgreencorridor.org/rapid_pv_permit_introduction.php

- 9 Bay area cities with a **regional, standardized permitting** process for most PV systems (up to 10 kW) on single-family homes
- Based on **housing stock common** to the area



Regional Approaches to Reform

East Bay Green Corridor Rapid PV Permit (CA)

www.ebgreencorridor.org/rapid_pv_permit_introduction.php

New streamlined permitting process allows for a **central website** that houses jurisdictional **permitting information** and **application materials**.

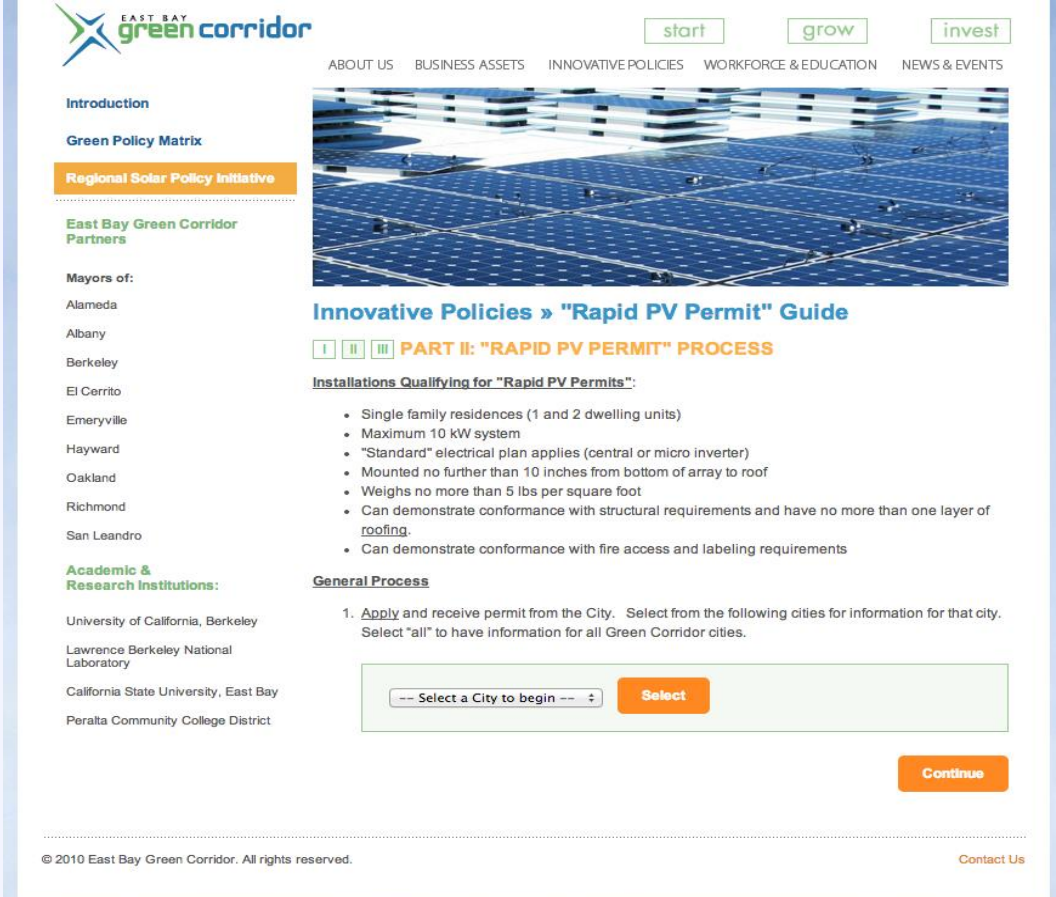

The screenshot displays the East Bay Green Corridor website interface. The header includes the logo and navigation links for 'start', 'grow', and 'invest'. A sidebar on the left lists navigation options: 'Introduction', 'Green Policy Matrix', 'Regional Solar Policy Initiative' (highlighted), 'East Bay Green Corridor Partners', 'Mayors of:' (listing Alameda, Albany, Berkeley, El Cerrito, Emeryville, Hayward, Oakland, Richmond, San Leandro), and 'Academic & Research Institutions:' (listing University of California, Berkeley, Lawrence Berkeley National Laboratory, California State University, East Bay, and Peralta Community College District). The main content area features a large image of solar panels and a section titled 'Innovative Policies » "Rapid PV Permit" Guide'. Below this, there are three numbered tabs, with the second tab 'PART II: "RAPID PV PERMIT" PROCESS' selected. Underneath, a section titled 'Installations Qualifying for "Rapid PV Permits":' lists several criteria. A 'General Process' section follows, with the first step being to 'Apply and receive permit from the City'. At the bottom of this section, there is a form with a dropdown menu labeled 'Select a City to begin' and an orange 'Select' button. A 'Continue' button is located at the bottom right of the page.

East Bay Green Corridor

start grow invest

ABOUT US BUSINESS ASSETS INNOVATIVE POLICIES WORKFORCE & EDUCATION NEWS & EVENTS

Introduction

Green Policy Matrix

Regional Solar Policy Initiative

East Bay Green Corridor Partners

Mayors of:

- Alameda
- Albany
- Berkeley
- El Cerrito
- Emeryville
- Hayward
- Oakland
- Richmond
- San Leandro

Academic & Research Institutions:

- University of California, Berkeley
- Lawrence Berkeley National Laboratory
- California State University, East Bay
- Peralta Community College District

Innovative Policies » "Rapid PV Permit" Guide

PART II: "RAPID PV PERMIT" PROCESS

Installations Qualifying for "Rapid PV Permits":

- Single family residences (1 and 2 dwelling units)
- Maximum 10 kW system
- "Standard" electrical plan applies (central or micro inverter)
- Mounted no further than 10 inches from bottom of array to roof
- Weighs no more than 5 lbs per square foot
- Can demonstrate conformance with structural requirements and have no more than one layer of roofing.
- Can demonstrate conformance with fire access and labeling requirements

General Process

1. Apply and receive permit from the City. Select from the following cities for information for that city. Select "all" to have information for all Green Corridor cities.

-- Select a City to begin -- Select

Continue

© 2010 East Bay Green Corridor. All rights reserved. [Contact Us](#)

Regional Approaches to Reform

East Bay Green Corridor Rapid PV Permit (CA)

www.ebgreencorridor.org/rapid_pv_permit_introduction.php

What else does this collaboration offer?

- Rapid over-the-counter permitting in 6 cities
- 3 to 7 day turnaround in 3 cities
- Cost-recovery permit fees or lower in all cities

Regional Approaches to Reform

NY State Unified Solar Permit Initiative

www.cuny.edu/about/resources/sustainability/nyssolar/NYSolarSmartPermitWorkshops.html

- Statewide, collaborative effort—NYSERDA, NYPA, municipalities, CUNY
- Based on Long Island Unified Solar Permit Initiative (LIUSPI)—which was modeled on Solar ABCs expedited permit process
- Municipal incentives available for permit adoption (\$2,500-\$5,000 depending on population)
- Regional workshops to encourage adoption

Poll

Do you think it would be useful to develop some or all of the pre-application materials?

- A. Yes
- B. No
- C. Unsure

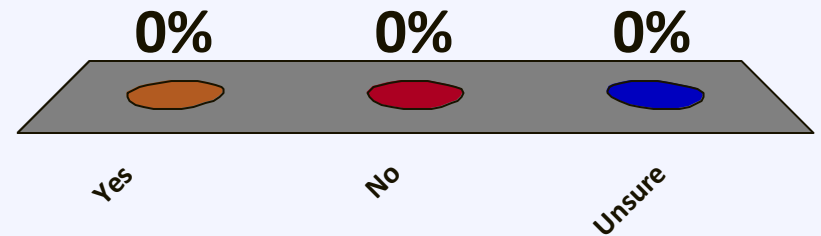

Poll

Checklist?

A. Yes

B. No

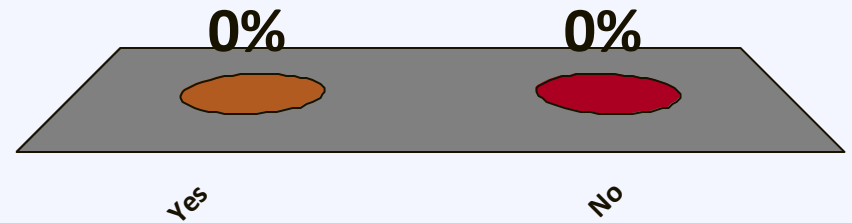

Poll

Guidebooks?

A. Yes

B. No

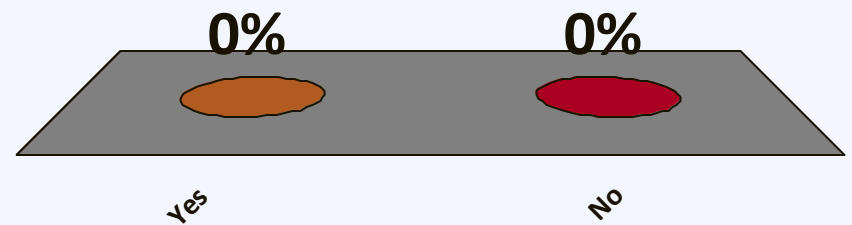

Poll

Website?

A. Yes

B. No

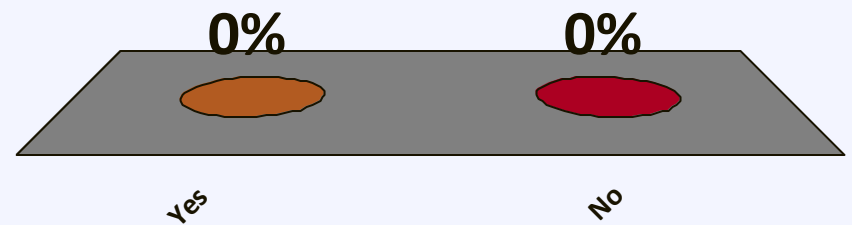

Poll

Do you think an expedited solar permitting process could be helpful in your jurisdiction?

A. Yes

B. No

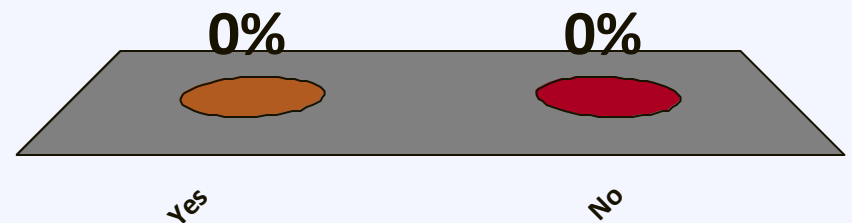

Poll

What is the most likely barrier to adopting an expedited permitting process?

- A. Needs elected official approval
- B. Insufficient resources
- C. Perception of favoritism
- D. Concerns about safety/quality
- E. No concerns
- F. Others

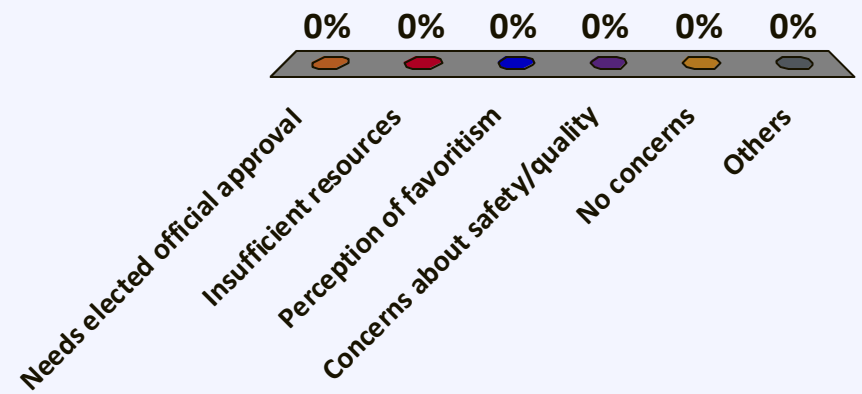

Poll

What would be your primary concern about doing only one inspection for residential solar?

- A. Inspector training
- B. Code compliance
- C. Installer qualifications
- D. No concerns

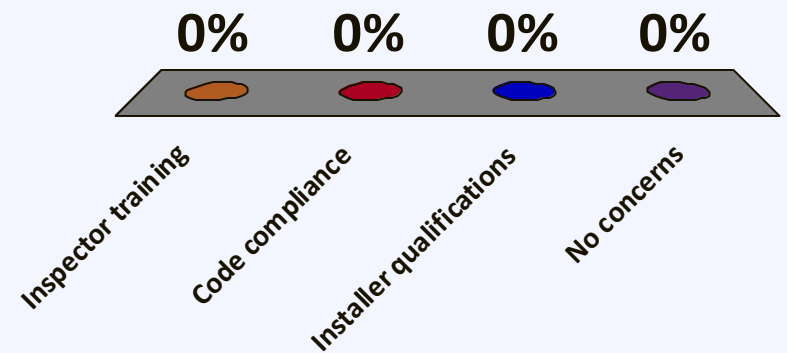

Conclusions and Take-Aways

Solar Permitting Best Practices

1. Post requirements online
2. Implement an expedited permit process
3. Enable online permit processing
4. Require a fast turn-around time
5. Implement reasonable fees
6. Do not require community-specific licenses
7. Offer a narrow inspection appointment window
8. Eliminate excessive inspections
9. Train permitting staff in solar

Project Permit: Best Practices in Residential Solar Permitting



1. **Post Requirements Online:** Information on permit fees, application requirements and process should be easily accessible via the city's website so applicants can review and prepare materials in advance. Municipalities should provide a submittal checklist of all requirements for rooftop solar PV and solar thermal permitting in a single online location. [Click here](#) for an example of a solar checklist.
2. **Implement an Expedited Permit Process:** The majority of small residential PV systems can be processed quickly if they meet clearly defined review requirements. We recommend adopting an expedited permitting review process for these systems that enables review over-the-counter or via electronic processing within one day. The *Solar ABC's Expedited Permit Process for PV Systems* provides a good example that can be adopted in full or used as a starting point. (Note, for larger systems, not covered by the *Expedited Permit* guidelines, municipalities should set and adhere to standard permitting requirements to make the process clear and transparent. The municipality should work to make these standards consistent with neighboring jurisdictions.) (NOT CURRENTLY GRADED IN PROJECT PERMIT)
3. **Enable Online Permit Processing:** Moving to a fully online permitting system can significantly reduce travel time for installers and workload for municipalities. We recommend adopting a system that enables submittal, review and approval of PV permits via email or a website within a short period of time.
4. **Require a Fast Turn Around time.** Offering a same-day 'over-the-counter' permit submission is a best practice. Travel to-and-from the building department can be one of the most cost intensive parts of the permitting process for installers. Obtaining a small PV permit should require no more than one visit to the building department for properly completed applications. If an over-the-counter option is not feasible, we at least suggest a permit turn around time of less than three days.
5. **Implement Reasonable Permitting Fees:** Using a flat-fee method instead of a value-based method to assess permit fees streamlines the process and ensures that larger solar energy systems are not arbitrarily penalized. Fees should fairly reflect the time needed for city staff to review and issue a permit - that's something that remains constant regardless of system size. A reasonable residential permit fee should be a flat fee of \$400 or less if best practices are followed.
6. **Do Not Require Community-Specific Licenses:** We recommend accepting NABCEP PV installer and solar thermal certification, or already existing state licensing requirements, in lieu of community-specific solar business licenses.
7. **Offer a Narrow Inspection Appointment Window:** Offering an exact appointment time, or keeping the windows for inspection appointments at or below two hours greatly reduces the amount of costly worker time spent waiting for inspectors to arrive. Inspectors could also call contractors as appointment time grows close to further save time.
8. **Eliminate Excessive Inspections:** We recommend a clearly defined plan review process and only one inspection for standard rooftop systems on existing homes. Eliminating reviews that do little to validate the safe and efficient operation of a proposed PV system (i.e. plan checks with aesthetic criteria) removes unnecessary costs and expedites permit issuance. We support having both qualified installers and inspectors proficient in solar to ensure safe and compliant installations.
9. **Train Permitting Staff in Solar:** Training building department staff to review permits and perform standard fire department checks reduces time and cost. Cities should make one or half-day workshops available to relevant staff. Trainings should be available to both building department plan check and review staff as well as for inspectors. [Click here](#) for free online training for code officials, developed by IREC. (NOT CURRENTLY GRADED IN PROJECT PERMIT)

For more information on solar permitting best practices visit www.projectpermit.org or email projectpermit@votesolar.org.



Regional Consistency

Further Resources

- IREC: Permitting, www.irecusa.org/regulatory-reform/permitting
 - Residential Solar Permitting Best Practices Explained
 - Simplifying the Solar Permitting Process: The Importance of Consistency
 - Guide to Preparing Solar Permitting Checklists
 - Model Inspection Checklist for Rooftop PV Systems
- Vote Solar <http://projectpermit.org>

SolarOPs Technical Assistance

Technical Assistance

- ‘Ask an Expert’ Web Portal
- Peer Exchange Facilitation
- In-Depth Consultations
- Customized Trainings

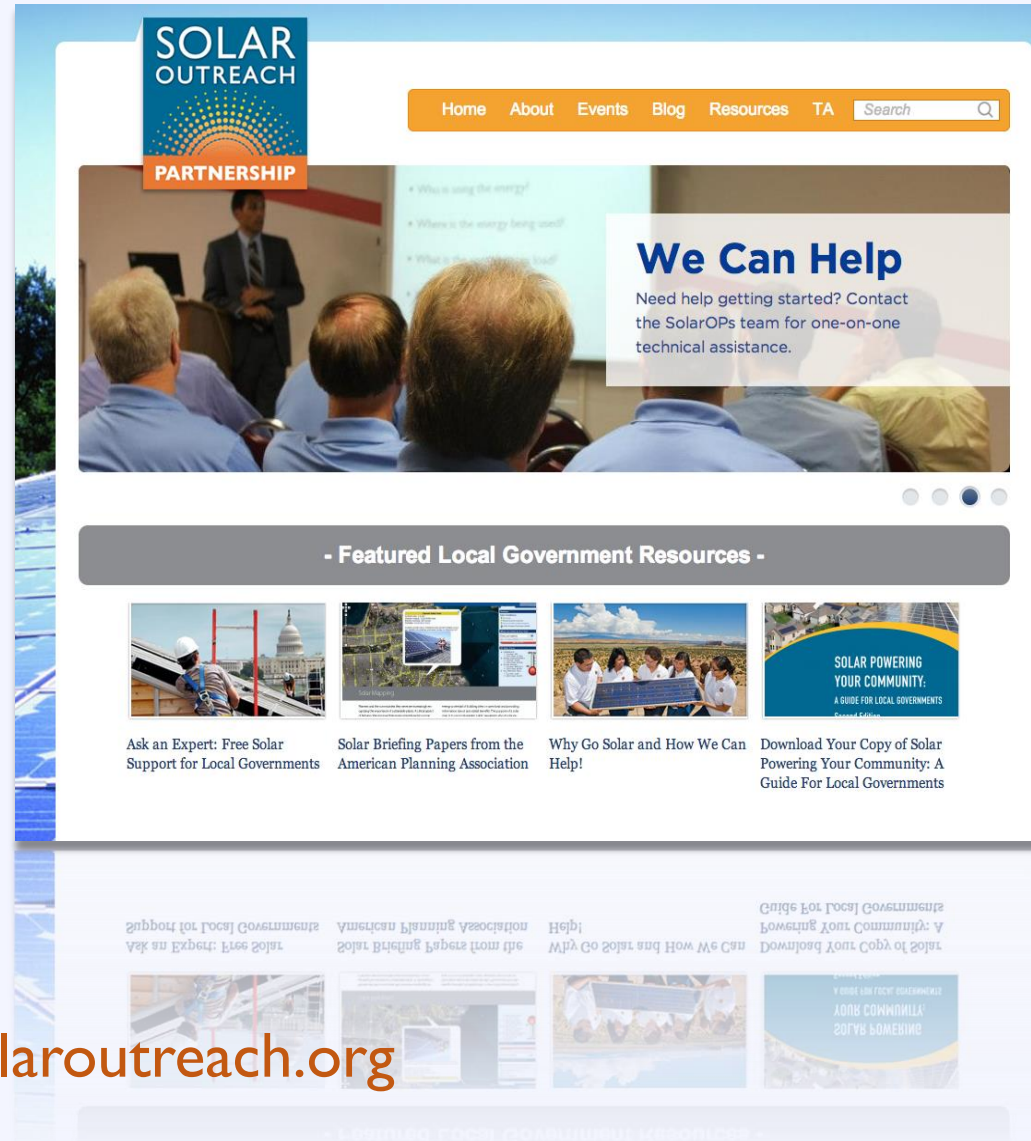

www.solaroutreach.org

Follow up and Questions

- Sky Stanfield
510-314-8204
sstanfield@kfwlaw.com

- Erica Schroeder McConnell
510-314-8206
emcconnell@kfwlaw.com

First Responder Training



SOUTH CAROLINA
STATE FIRE

Photovoltaic (PV) Fire Marshal Training
May 13–15, 2015



Chief Deputy Stickle
803-834-0944
Shawn.Stickle@lfr.sc.gov

Presentation will be available through the
South Carolina Fire Academy soon!

Chief Deputy Stickle
803-834-0944
Shawn.Stickle@lfr.sc.gov

Duke Energy's Experience

Fire Protection, Fire Safety at Solar PV Arrays

National Gypsum Manufacturing Facility, Mount Holly, NC



1.2 megawatt rooftop PV array (5,252 panels each 230 kW)



April 16, 2011 (Saturday) – 12:45PM



PV Solar Rooftop Incident - Mt. Holly, North Carolina - April 16, 2011

Incident: PV Solar Fire

When: April 16, 2011

Where: Rooftop of Manufacturing Facility in Mount Holly, NC

What: Fire damaged or destroyed solar panels, combiner box 2F (fire), combiner box 2A (arching), and roofing.

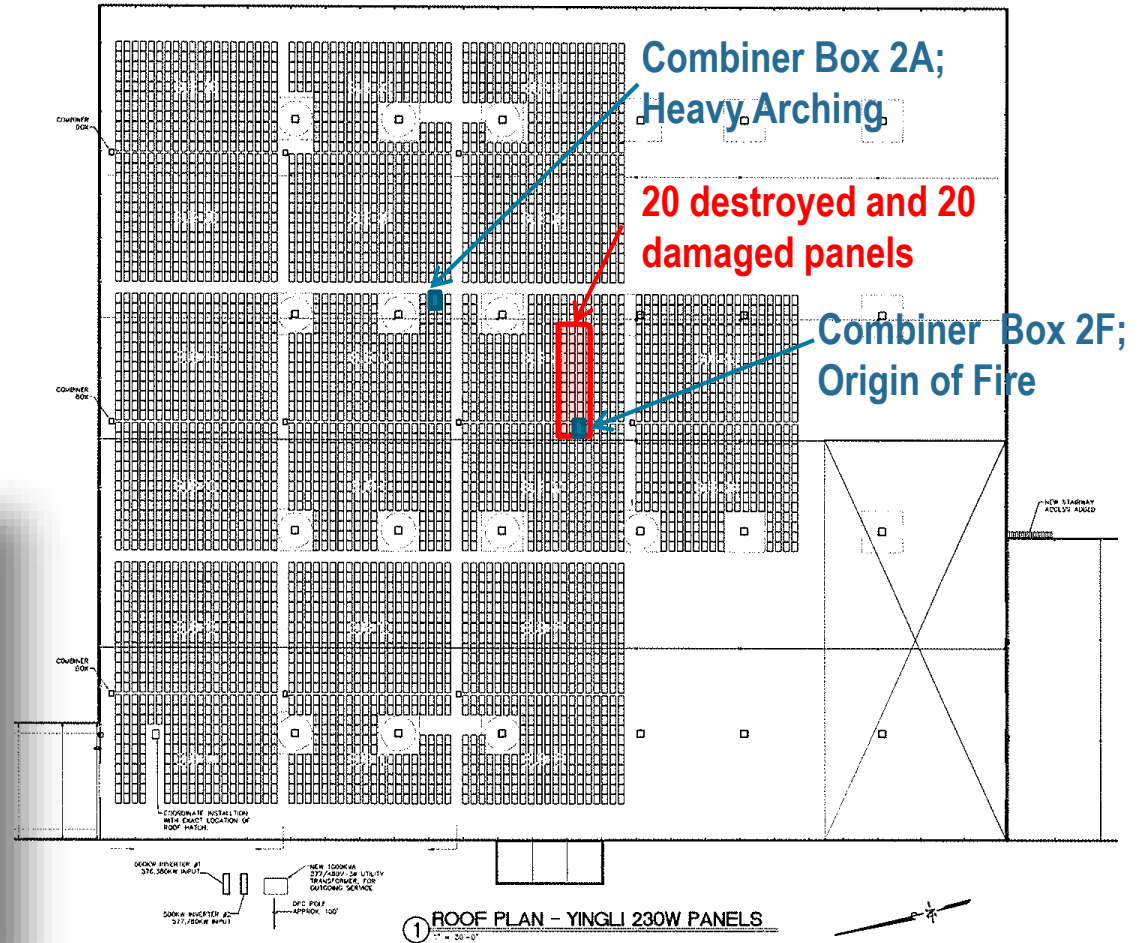

5,252 230-Watt PV modules; Two inverters 500 kW inverters and one 135 kW inverter.

Report of the Results of the Investigation of Failure of the 1.135 MW Photovoltaic (PV) Plant at the National Gypsum Facility in Mount Holly, North Carolina



Prepared for:

Duke Energy

526 South Church St.
Charlotte, NC 28202-1904

Prepared by:

Brooks Engineering
873 Kells Circle
Vacaville, CA 95688
www.brooksolar.com



May 26, 2011

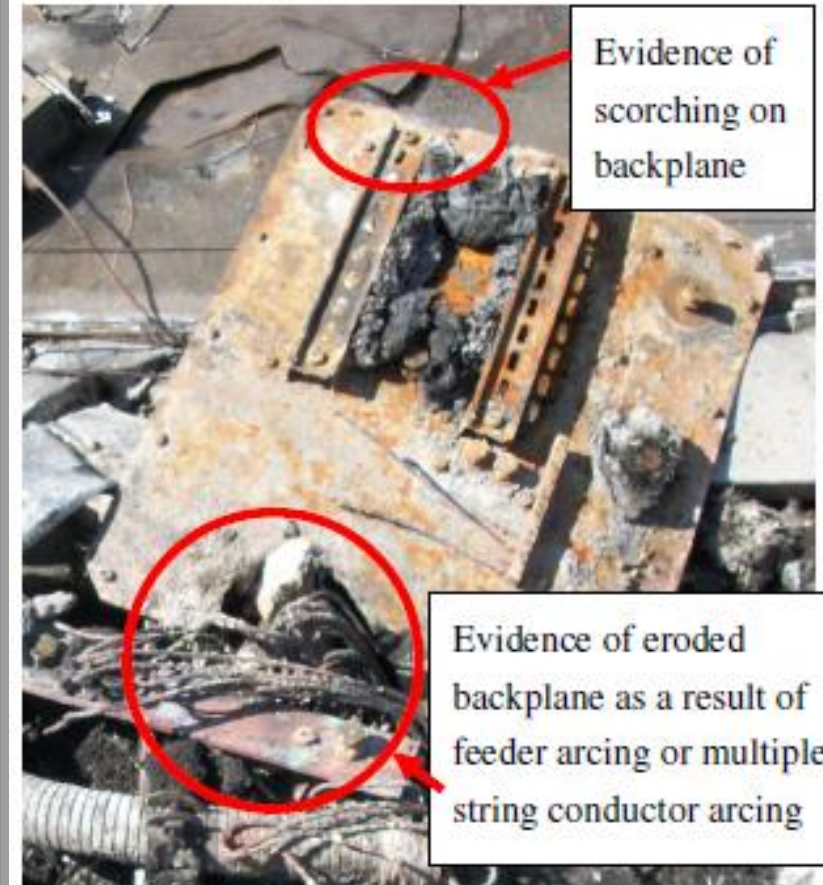

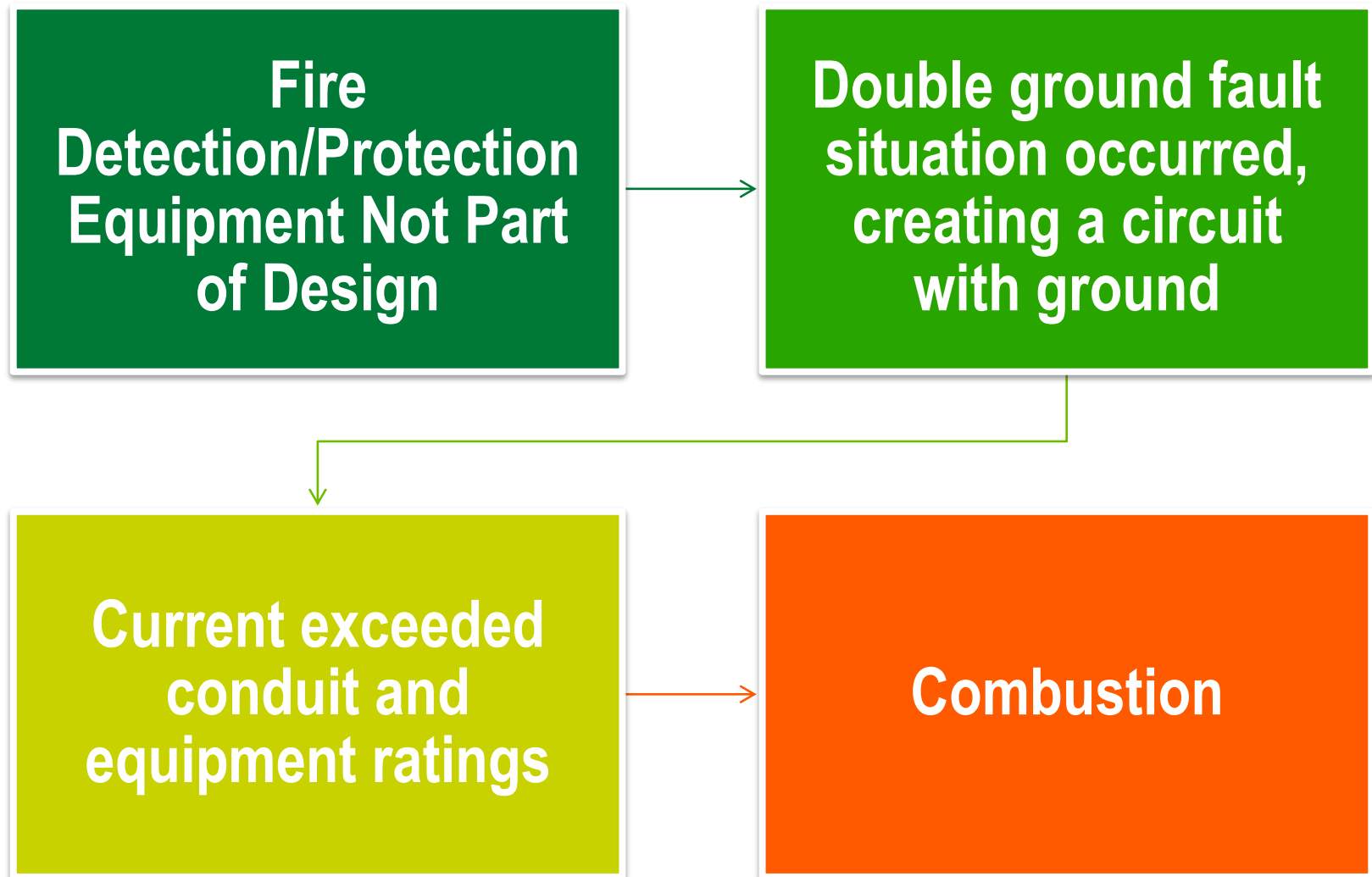

Contributing Factors include increased solar irradiance after storm, strong winds, some poor installation practices, thermal expansion, certain industry practices

Better conduit management on large arrays



Monitor array at lower levels, higher frequency



Notify operator immediately



Automatically Shut-Off when thresholds exceeded

Thank you!