

Draft Final Report • National Institute of Standards and Technology (NIST)

Technical Investigation

of the May 22, 2011,
Tornado in
Joplin, Missouri

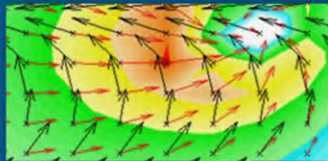

NIST NCSTAR 3 (Draft)

For Public Comment

Draft Final Report, National Institute of Standards and Technology (NIST)

Technical Investigation of the May 22, 2011, Tornado in Joplin, Missouri

Erica D. Kuligowski

Franklin T. Lombardo

Long T. Phan

Marc L. Levitan

Engineering Laboratory

National Institute of Standards and Technology

David P. Jorgensen

Warning R&D Division

National Severe Storms Laboratory

National Oceanic and Atmospheric Administration

November 2013



U.S. Department of Commerce
Penny Pritzker, Secretary

National Institute of Standards and Technology
*Patrick D. Gallagher, Under Secretary of Commerce
for Standards and Technology and Director*

Disclaimer No. 1

Certain commercial entities, equipment, or materials may be identified in this document in order to describe an experimental procedure or concept adequately. Such identification is not intended to imply recommendation or endorsement by the National Institute of Standards and Technology, nor is it intended to imply that the entities, materials, or equipment are necessarily the best available for the purpose.

Disclaimer No. 2

NIST takes no position as to whether the design or construction of any building discussed in this report was compliant with any code.

Disclaimer No. 3

The policy of NIST is to use the International System of Units in all publications. In this document, however, units are presented in the system prevalent in the relevant discipline, although in some cases more than one system of units may be presented.

Use in Legal Proceedings

No part of any report resulting from a NIST investigation into a structural failure or from an investigation under the National Construction Safety Team Act may be used in any suit or action for damages arising out of any matter mentioned in such report (15 U.S.C. 281a, as amended).

Copyright

This NIST publication is a work of the United States Government not subject to copyright protection within the United States under Title 17 United States Code § 105. This publication may include copyrighted content (such as photographs) used with permission of the credited copyright holder. Reproduction, redistribution or reuse of such copyrighted content apart from this publication may require permission, which should be sought from the credited copyright holder. Where no copyright holder or source is credited for a figure or table in this publication, the source is NIST, which would appreciate attribution.

**National Institute of Standards and Technology National Construction Safety Team Act Report 3 (Draft)
Natl. Inst. Stand. Technol. Natl. Constr. Sfty. Tm. Act Rpt. 3 (Draft), 488 pages (November 2013)
CODEN: NSPUE2**

Cover images (clockwise from top left): National Construction Safety Team member interviews Joplin tornado survivor (source NIST); ground (source FEMA Mitigation Assessment Team) and aerial (source NOAA) views of St. John's Regional Medical Center; tornado wind field model (source NIST).

Title page image: St. John's Regional Medical Center (source NIST).

**NATIONAL CONSTRUCTION SAFETY TEAM
FOR THE NIST TECHNICAL INVESTIGATION
OF THE MAY 22, 2011,
TORNADO IN JOPLIN MISSOURI**

Marc L. Levitan, Ph.D. (NIST), Lead Investigator

David P. Jorgensen, Ph.D. (NOAA)

Erica D. Kuligowski, Ph.D. (NIST)

Franklin T. Lombardo, Ph.D. (NIST)

Long T. Phan, Ph.D. P.E. (NIST)

This page intentionally left blank.

CONTRIBUTORS TO THE INVESTIGATION

National Construction Safety Team

Marc L. Levitan	Lead Investigator
Franklin T. Lombardo	Task Leader, Tornado Hazard Characteristics
David P. Jorgensen	Task Co-Leader, Tornado Hazard Characteristics
Long T. Phan	Task Leader, Performance of Buildings, Designated Safe Areas, and Lifelines as Related to Continuity of Building Operations
Erica D. Kuligowski	Task Leader, Emergency Communications, Public Response, and Fatalities and Injuries

NIST Technical Staff

Eric Letvin, Project Manager	John Gross	Nancy McNabb
Jason Averill	Rik Johnson	Fahim Sadek
Steve Cauffman	H. S. Lew	Emil Simiu
Andrew Flynn	Therese McAllister	

NIST Institutional Support

Kellie Beall	Jennifer Horning	Carolyn Sandler
Ami Carbaugh	Melissa Leiberman	Linda Beth Schilling
Sonum Chaudhari	Darren Lowe	S. Shyam Sunder
Kirk Dohne	Mark Madsen	Rose Van Camp
Tina Faecke	Andrew Mundy	Darla Yonder
Catherine Fletcher	Michael E. Newman	Bessmarie Young
Howard Harary	Gail Porter	Henry Wixon
Michelle Harman	Carolyn Rowland	

NIST Contractors

<u>Applied Research Associates</u>	<u>BRI Consulting Group</u>	Jen Spinney
Frank Lavelle	Brian Garrett	
David Mizzen		

External Peer Reviewers

Harold Brooks	Dennis S. Mileti	Sarah A. Rice
Susan L. Cutter	R. Shankar Nair	Thomas W. Schmidlin
Larry Griffis	Eric K. Noji	John T. Snow
Jeremy Isenberg	James R. Quiter	Lawrence A. Twisdale
Anne S. Kiremidjian	Timothy A. Reinhold	Peter J. Vickery

National Construction Safety Team Advisory Committee

Ron J. Coleman
Paul A. Croce
Susan L. Cutter
Carlos Fernandez–Pello

Jeffrey L. Garrett
Jeremy Isenberg
Anne S. Kiremidjian
R. Shankar Nair

James R. Quiter
Sarah A. Rice

ACKNOWLEDGEMENTS

The National Institute of Standards and Technology (NIST) would like to gratefully acknowledge the assistance of all who provided data and information in support of this investigation. NIST has received considerable cooperation and information from a variety of businesses, organizations, professional associations, and individuals representing building designers, building owners, utilities, media, disaster researchers, and disaster responders. NIST has also received considerable cooperation and information from citizens in the Joplin area, as well as from Federal, State, and local authorities.

Local authorities providing information include the Joplin Public Works Department, the Joplin Police Department, the Joplin Fire Department, Joplin Schools, Joplin/Jasper County Emergency Management Agency, and Jasper County Geographic Information Services. State authorities providing information include the Missouri Department of Public Safety's State Emergency Management Agency, the Missouri Department of Health and Senior Services, the Missouri State Highway Patrol, the Missouri Division of Fire Safety, the Oklahoma State Department of Health, and the Kansas Department of Health and Environment's Office of Vital Statistics. Federal authorities providing information include the U.S. Army Corps of Engineers, the Federal Emergency Management Agency (FEMA), the National Oceanic and Atmospheric Administration's National Weather Service (NWS), and the U.S. Department of Health and Human Services' Centers for Disease Control and Prevention.

NIST has also received information from the American Red Cross; Mercy (the parent organization of St. John's Regional Medical Center); GeoEye, Inc.; architectural and engineering design firms Allgeier, Martin and Associates, Inc., Heery International, Inc., and Patterson Latimer Jones Brannon Denham (PLJBD) Inc; the Structural Engineers Association of Kansas and Missouri; the Missouri Structural Assessment and Visual Evaluation (SAVE) Coalition; utilities Empire District Electric Company and Missouri Gas Energy; and news and media companies KGCS-TV, KOAM-TV, Nexstar Broadcasting, Inc, KMXL-FM, Zimmer Radio, Inc., and The Joplin Globe.

NIST would also like to thank FEMA, the National Oceanic and Atmospheric Administration, and National Science Foundation for their input to the report.

This page intentionally left blank.

DEDICATION

On the evening of May 22, 2011, a powerful tornado struck southwestern Missouri. After the storm passed, the City of Joplin, which bore the brunt of the storm, was faced with decisions on how to rebuild a city that was not only damaged physically, but also emotionally, with the loss of 161 lives. Immediately after the storm hit, the construction, building, healthcare and public safety communities began asking a pressing question: How can we reduce our vulnerability, and increase our preparedness and safety, in such weather events?

This investigation has, to the extent possible, reconstructed the characteristics of the tornado and the response of buildings, of lifelines, and of the people who found themselves in its path that fateful evening. The purpose was to make recommendations for improvements to building and emergency communications codes, standards and practices that lead to more tornado-resilient communities. For that reason, this report is dedicated to those lost in this tornado disaster, to those who have suffered from its impacts, and to those who will carry the findings of this report forward to improve the safety of people in future tornado disasters.

This page intentionally left blank.

ABSTRACT

This is the final report of the National Institute of Standards and Technology (NIST) investigation of the May 22, 2011 tornado in Joplin, Missouri, conducted under the National Construction Safety Team Act. This report describes the wind field of the tornado and how the wind pressures and windborne debris damaged and destroyed thousands of buildings; the emergency communications before and during the tornado and how the public responded; the influence of tornado hazards and public response and building and designated shelter area performance on survival and injury; and areas of current building and emergency communications codes, standards and practices that warrant revision.

Also described in this report is the means by which NIST reached its conclusions. NIST collected large numbers of documents, photographs, videos, and building plans; developed a computer model of the wind field of the tornado as it crossed the City of Joplin; analyzed the performance of a range of building types for life safety and functionality; interviewed many survivors of the tornado, developed an evidence-based explanation for decisions made and actions taken by the public in response to the tornado; and analyzed the factors affecting life safety outcomes.

The report outlines 47 findings related to the May 22, 2011, Joplin tornado and concludes with a list of 16 recommendations for action in areas of improved measurement and characterization of tornado hazards, new methods for tornado resistant design of buildings, enhanced guidance for community tornado sheltering, and improved and standardized emergency communications.

Keywords: building performance, designated safe area, emergency communications, fatalities, injuries, Joplin Missouri, lifeline performance, structural collapse, tornado.

This page intentionally left blank.

TABLE OF CONTENTS

National Construction Safety Team for the NIST Technical Investigation of the May 22, 2011 Tornado in Joplin, Missouri.....	iii
Contributors to the Investigation.....	v
Acknowledgements.....	vii
Dedication.....	ix
Abstract.....	xi
Table of Contents.....	xiii
List of Figures.....	xxi
List of Tables.....	xxxv
List of Acronyms and Abbreviations.....	xxxvii
Metric Conversion Table.....	xli
Executive Summary.....	xliii
 Chapter 1	
Introduction.....	1
1.1 The City of Joplin.....	1
1.2 The Event.....	6
1.3 The Toll.....	19
1.4 NIST’s Joplin Tornado Investigation.....	19
1.4.1 Goals.....	20
1.4.2 Objectives.....	20
 Chapter 2	
Tornado Hazard Characteristics.....	23
2.1 Introduction.....	23
2.2 Meteorological Conditions.....	23
2.2.1 Objective.....	23
2.2.2 Joplin Environment and Timeline.....	23

2.3	Near–Surface Wind Environment	30
2.3.1	Objective	30
2.3.2	Tornado Wind Field Regions	30
2.3.3	Direct Wind Speed Observations	33
2.3.3.1	Wind Environment	33
2.3.4	Indirect Wind Speed Estimation.....	34
2.3.4.1	Observed Damage (EF Scale).....	34
2.3.4.2	Tornado Wind Field Model	39
2.4	Description of the Tornado Hazard in the United States	56
2.4.1	Objective	56
2.4.2	Tornado Climatology	56
2.4.2.1	NOAA Tornado Database	56
2.4.2.2	Tornado–Induced Losses.....	57
2.4.2.3	Tornado Hazard Analysis	58
2.4.3	Urbanization of Communities	67
2.5	Enhanced Fujita Scale Assessment.....	68
2.5.1	Objective	68
2.5.2	History.....	68
2.5.3	Current Practice/Guidance.....	68
2.5.4	Recent Observations Using the EF Scale	69
2.6	Summary.....	70
2.6.1	Meteorological Conditions	70
2.6.2	Near–Surface Wind Environment	70
2.6.3	Description of the U.S. Tornado Hazard	72
2.6.4	Enhanced Fujita Scale Assessment	72
2.7	References.....	73
Chapter 3		
	Performance of Buildings, Designated Safe Areas, and Lifelines	77
3.1	Introduction.....	77

3.1.1	Overall Extent of Damage	77
3.1.2	Scope of Structures Surveyed and of This Chapter	79
3.1.3	Methodology for Building Performance Evaluation	85
3.1.4	Tornado Design: A National Perspective	86
3.1.5	History of Building Code Adoption in Joplin	89
3.2	Performance of Buildings	91
3.2.1	Critical Facilities and High–Occupancy Buildings	92
3.2.1.1	St. John’s Regional Medical Center	92
3.2.1.2	Walmart	120
3.2.1.3	Home Depot.....	129
3.2.1.4	Joplin East Middle School.....	139
3.2.1.5	Joplin High School	151
3.2.1.6	Franklin Technology Center.....	159
3.2.1.7	St. Mary’s Catholic Elementary School	164
3.2.1.8	Summary of Performance of Critical Facilities and High–Occupancy Buildings.....	167
3.2.2	Commercial Buildings.....	169
3.2.2.1	Ozark Center for Autism	169
3.2.2.2	St. Paul’s United Methodist Church	175
3.2.2.3	Ramesh Shaw Ophthalmologist.....	179
3.2.2.4	Summary of Performance of Commercial Buildings	183
3.2.3	Residential Buildings	184
3.2.3.1	Multi–Family Residential Buildings	185
3.2.3.2	Single–Family Residential Buildings	197
3.2.3.3	Summary of Performance of Residential Buildings	203
3.3	Performance of Designated Safe Areas and Shelters.....	203
3.3.1	Commercial High–Occupancy Facilities.....	205
3.3.1.1	Designated Refuge Area at Walmart.....	205
3.3.1.2	Designated Refuge Area at the Home Depot.....	206

3.3.2	Schools	210
3.3.2.1	Designated Safe Areas at Joplin East Middle School.....	210
3.3.2.2	Designated Refuge Areas at Joplin High School.....	210
3.3.3	High–Occupancy Health Care Facilities	213
3.3.3.1	Designated Refuge Areas at Ozark Center for Autism.....	213
3.3.3.2	Designated Refuge Areas at SJRMC.....	215
3.3.3.3	Designated Refuge Areas at the Greenbriar Nursing Home.....	217
3.3.4	In–Home Shelters	217
3.3.4.1	In–Home Steel Shelter.....	219
3.3.4.2	In–Home Kevlar–Reinforced Shelter	219
3.3.5	Summary of Performance of Shelters/Designated Refuge Areas.....	219
3.4	Performance of Lifelines as Related to Building Functionality.....	222
3.4.1	Overall Tornado Effect on Lifelines in Joplin.....	222
3.4.1.1	Electricity	222
3.4.1.2	Water	224
3.4.1.3	Natural Gas.....	226
3.4.1.4	Communications.....	226
3.4.2	Effect of Lifeline Disruptions on Building Operations	228
3.4.3	Summary of Performance of Lifelines	231
3.5	References.....	232
Chapter 4		
	Emergency Communications and Public Response.....	235
4.1	Public Response in Disasters	235
4.2	Data Collection	237
4.2.1	Data on Public Response.....	238
4.2.2	Data on Consequences of the Tornado—Injuries and Deaths.....	240
4.2.3	Data on Emergency Response	242
4.3	Joplin, Missouri, Before the Tornado of May 22, 2011.....	242
4.3.1	Emergency Communications—Outdoor Warning Systems	243

4.3.2	Emergency Communications—Other Modes of Communication.....	246
4.3.3	Sheltering Procedures for Tornadoes	247
4.3.4	Tornado History in the Joplin Area	248
4.4	Joplin, Missouri, on May 22, 2011—The Tornado Hits	250
4.4.1	Elks Lodge.....	254
4.4.2	St. John’s Regional Medical Center	254
4.4.3	Stained Glass Theater	261
4.4.4	Greenbriar Nursing Home	264
4.4.5	Places of Worship.....	265
4.4.6	AT&T Store.....	268
4.4.7	Home Depot	270
4.4.8	Pizza Hut	272
4.4.9	Walmart Store #59.....	274
4.4.10	Single-Family Homes and Apartment Complexes	277
4.4.11	In Vehicles or Outdoors.....	287
4.4.12	Additional Locations of Fatalities in Joplin	292
4.5	Casualties from the May 22, 2011, Joplin Tornado	292
4.5.1	Settings in Which Fatalities Occurred.....	293
4.5.2	Basic Causes of Deaths and Injuries	293
4.5.3	Date of Death.....	294
4.5.4	Demographics.....	295
4.5.4.1	Gender	295
4.5.4.2	Age—Deaths	295
4.5.4.3	Age—Injuries	298
4.5.5	Summary Questions and Findings Related to Casualties	298
4.6	The Influence of Environmental Conditions on Casualties	299
4.6.1	The Influence of Environmental Conditions on Casualties Outside of Buildings.....	303
4.6.2	The Influence of Environmental Conditions on Casualties Inside of Buildings	307
4.6.2.1	Non-Residential Structures	309

4.6.2.2 Residential Buildings.....	319
4.6.3 Summary	323
4.7 The Influence of Emergency Communications and Public Response on Casualties Both Inside and Outside of Buildings.....	325
4.7.1 Protection Is Unnecessary	329
4.7.1.1 No General Risk Perceived.....	329
4.7.1.2 No Personal Risk Perceived (“It Will Not Happen to Me”).....	332
4.7.2 Protective Action Is Necessary.....	336
4.7.2.1 Confirmation Is Achieved After Initial Warnings	336
4.7.2.2 Personal Risk Is Perceived	337
4.7.2.3 Other Actions During Decision Making.....	338
4.7.3 Other Important Factors Related to Casualties.....	338
4.8 Chapter Summary	339
4.9 References.....	342
Chapter 5	
Findings and Recommendations	349
5.1 Principal Findings	349
5.1.1 Context for Findings.....	349
5.1.2 Findings Related to Tornado Hazard Characteristics and Associated Wind Field.....	350
5.1.2.1 Measurements of the Near–Surface Wind Field in Tornadoes (< 20 m).....	350
5.1.2.2 Assessment of Tornado Climatology, Hazard, and Risk for Structural Design.....	351
5.1.2.3 Limitations of the Enhanced Fujita (EF) Scale.....	351
5.1.3 Findings Related to the Response of Residential, Commercial, and Critical Buildings, Including the Performance of Designated Safe Areas and of Lifelines Pertaining to the Continuity of Building Operations.....	351
5.1.3.1 Building Performance.....	351
5.1.3.2 Performance of Shelters/Safe Rooms/Designated Refuge Areas	353
5.1.3.3 Performance of Lifelines	354

5.1.4 Findings Related to the Pattern, Location, and Cause of Fatalities and Injuries, and Associated Performance of Emergency Communications Systems and Public Response.....	354
5.1.4.1 Emergency Communication Prior to May 22, 2011	355
5.1.4.2 Tornado History Prior to May 22, 2011	355
5.1.4.3 Emergency Communication on May 22, 2011	355
5.2 Recommendations.....	357
5.2.1 Recommendations Related to Tornado Hazard Characteristics and Associated Wind Field.....	358
5.2.2 Recommendations Related to the Performance of Buildings, Shelters/Designated Safe Areas, and Lifelines.....	361
5.2.3 Recommendations Related to the Pattern, Location, and Cause of Fatalities and Injuries, and Associated Performance of Emergency Communications Systems and Public Response	367
Appendix A	
Mesoscale Discussions Issued on May 22, 2011, That Included Joplin	371
A.1 Mesoscale Discussion 853	371
A.2 Mesoscale Discussion 862	372
A.3 Mesoscale Discussion 867	373
Appendix B	
EF–Scale Rating for Random Residential Structures	375
Appendix C	
Model Grid Coordinates	377
Appendix D	
Tornado Wind Field Model	379
Appendix E	
Modeled Wind Speed and Direction Time Histories at Select Locations.....	387
Appendix F	
Tornadoes per Year Maps (EF-0 Through EF-5).....	393
Appendix G	
History of Code Adoptions by the City of Joplin	397

Appendix H	
Estimated Design Wind Pressure and Strengths of Connections of Joplin Walmart Building #59	403
H.1 Estimated Design Wind Pressure Based on IBC 2000.....	403
H.2 Estimated Uplift Strength Of Roof Joist–To–Joist Girder Connections	404
Appendix I	
Estimated Design Wind Pressure and Strengths of Connections of Joplin Home Depot Building	405
I.1 Estimated Design Wind Pressure Based on Boca NBC/1996	405
I.2 Roof Bracing Forces R_T	407
I.3 Roof Diaphragm Shear and Stiffness	409
I.4 Uplift and Shear Capacities of Roof Deck–to–Joist Connections	410
Appendix J	
Estimated Design Wind Pressure for Joplin East Middle School Gymnasium.....	413
Appendix K	
Qualitative Analysis of the Current State of Tornado Warning Systems in the U.S.	415
Appendix L	
U.S. Codes and Standards on Outdoor Warning Systems	419
Appendix M	
NOAA/NWS Warning Text for the Joplin Tornado.....	423
M.1 Warning Issued at 5:09 PM CDT	423
M.2 Warning Issued at 5:17 PM CDT	424
Appendix N	
Methods for Development of Evidence-Based Explanation of Decision-Making in Joplin Tornado	427

LIST OF FIGURES

Figure 1–1.	Location of Joplin (circled in red) in south western Missouri.	1
Figure 1–2.	Map of Joplin and surrounding area.	2
Figure 1–3.	Damage from the 1971 Joplin tornado.....	5
Figure 1–4.	Initial damage in the Joplin tornado. Yellow arrows indicate directions of tree fall. Possible multiple vortices shown by red arrows.	8
Figure 1–5.	Damage on the west side of Joplin.	9
Figure 1–6.	Aerial photo showing damage to St. John’s Regional Medical Center and the surrounding area.....	11
Figure 1–7.	Aerial photo showing locations of the Ozark Center for Autism, Greenbriar Nursing Home, St. Mary’s Catholic Elementary School, and EDE substation 59 (from west to east). Residential area is outlined in white.....	13
Figure 1–8.	Aerial photo showing the locations of a heavily damaged residential area, Franklin Technology Center, Joplin High School, and Harmony Heights Baptist Church. The color of each building footprint shows the level of damage to that structure.	14
Figure 1–9.	Aerial photo of damaged residential areas (including apartment complexes) in Joplin near the intersection of 20th and Connecticut.	15
Figure 1–10.	Aerial photo showing damage to a commercial area on the eastern side of Joplin near the intersection of Range Line Road and 20th Street.	16
Figure 1–11.	Aerial photo of damage to a residential area and Joplin East Middle School.....	18
Figure 2–1.	500 millibar (mb) analysis at 7 a.m. CDT (1200 Coordinated Universal Time (UTC)) on May 22, 2011.	24
Figure 2–2.	Surface analysis at 7 p.m. CDT (0000 UTC, May 23, 2011) on May 22, 2011.	24
Figure 2–3.	Wind shear and CAPE for severe thunderstorm environments. "Best Discriminator" line denotes areas to right and above as being more favorable for significant severe thunderstorms.....	25
Figure 2–4.	Tornado outlook issued by NOAA’s Storm Prediction Center at 1 a.m. CDT (0600 UTC) on May 22, 2011.	26
Figure 2–5.	Tornado warnings issued by the Springfield NWS office on May 22, 2011. Zulu time, or Z, in the figure is the same as UTC time (Z = UTC). Estimated NWS track of the Joplin tornado shown outlined in brown.	28

Figure 2–6.	Timeline of watches, warnings, sirens, and the tornado itself.	28
Figure 2–7.	Radar reflectivity sequence from the Springfield radar. Radar reflectivity is the right panel and radial velocity is the left panel of each image. For radial velocity, red to yellow colors indicate winds receding from the radar (which is located to the east of Joplin), green to white colors indicate winds approaching the radar. These colors in close proximity suggest rotation and signify the approximate tornado position. A "hook echo" is seen in reflectivity images, also a possible indication of a tornado. These features are annotated in the 2248 UTC panel.	29
Figure 2–8.	Center of Joplin tornado track as estimated by NIST.	30
Figure 2–9.	General tornado flow regions.....	31
Figure 2–10.	Normalized Rankine vortex showing maximum wind speed at RMW ($\phi=1.0$).	32
Figure 2–11.	Generalized wind vector for a point denoted by the small gray circle. RMW is distance from gray circle to "tornado center."	32
Figure 2–12.	Time history of mean and gust wind speed and mean wind direction from the Joplin ASOS station (KJLN) from 5 p.m. to 6 p.m. CDT (2200–2300 UTC), on May 22, 2011. Boxed area is approximate time when the tornado was on the ground in Joplin.	33
Figure 2–13.	Aerial photo of Walmart Store #39 showing extensive damage to the southern (bottom) half of the building.....	36
Figure 2–14.	Elevation view of southwest–facing wall of Walmart Store #39.....	36
Figure 2–15.	Building footprints in part of Joplin showing damage classes. St. Mary’s Catholic Elementary School (red box) shown for reference. Area shown is approximately 1.0 miles west to east and 0.8 miles north to south.	38
Figure 2–16.	Grid system for tree fall analysis in Joplin. Each dot denotes a tree/wind–field point spaced at every 0.05 miles. The grid extends 6.2 miles west to east and 2.0 miles north to south.....	43
Figure 2–17.	Grid overlaid with Rankine vortex model results. Red arrows represent current wind direction, black arrows represent direction of tree fall, and contouring illustrates wind speed field.	44
Figure 2–18.	Observed tree fall pattern between 20th and 32nd streets just east of Schifferdecker Ave. Area is approximately 0.5 miles west to east by 1.0 miles north to south.	45
Figure 2–19.	Example of procedure for comparing observed tree fall to modeled tree fall. Output parameters are also listed.....	47
Figure 2–20.	Ranges and best estimate of wind speed (left) and associated wind direction (right) for $X = 2781933$ ft, $Y = 326052$ ft; Grid Point #1175. Best estimates are the bold traces on each plot.....	48

Figure 2–21.	Translation direction (θ_T) changes in the Joplin tornado. Numbers are approximate directions in degrees. White line indicates estimated center of tornado path. The area in the figure is approximately 6.2 miles west to east and 2.0 miles north to south.....	48
Figure 2–22.	Example of a modeled best estimate of tornado wind speed and direction time history associated with the Joplin tornado ($X = 2.1, Y = 0.45$).	49
Figure 2–23.	Estimated maximum wind speed grid points from tornado wind field model grid points grouped by EF Scale. The solid black line represents the estimated tornado center. The area in the figure is approximately 6.2 miles west to east and 2.0 miles north to south... ..	50
Figure 2–24.	Estimated maximum wind speed polygons from tornado wind field model grouped by EF Scale. The solid black line represents the estimated tornado center. The area in the figure is approximately 6.2 miles west to east and 2.0 miles north to south.	50
Figure 2–25.	Illustration of differences in Rankine vortex model given ϕ parameter.	51
Figure 2–26.	Best estimate of duration of wind speeds greater than or equal to EF–2 (≥ 110 mph). Green line shows estimated tornado center. The area in the figure is approximately 6.2 miles west to east and 2.0 miles north to south.....	51
Figure 2–27.	Three distinct ranges of maximum wind speed based on different values of translational speed (VT) for Grid Point #1175 ($X = 2.1, Y = 0.45$). Red dots illustrate the combinations of V using the range values of VT and Gmax.	53
Figure 2–28.	Average fatalities per tornado and total fatalities by EF number (1950–2011).	57
Figure 2–29.	Average loss per tornado and total loss (2011 dollars) by EF number.	58
Figure 2–30.	Illustration of point–based probability approach.	59
Figure 2–31.	Example of spatially based approach within a given region.....	62
Figure 2–32.	Probability density function of EF–2 or stronger tornadoes. Black dots represent individual touchdown locations. Warmer colors represent higher probability and probability values are shown on contour lines. Data Source: NOAA. Analysis by NIST.	64
Figure 2– 33.	Probability density of EF–2 or greater tornadoes from 1980 through 2011 with EF–2 or stronger tornadoes per year values shown at each grid point. Data Source: NOAA. Analysis by NIST.....	65
Figure 2– 34.	Illustration of spatially based analysis. Contoured values are return period (MRI) in years for EF–2 or stronger tornadoes.	67
Figure 3–1.	Westernmost (earliest) segment of the tornado path through Joplin, showing locations of facilities surveyed by NIST relative to the estimated center line of the tornado damage path (red solid line). The color coded building footprints indicate the estimated level of damage to individual structures (see legend above).. ..	82

Figure 3–2.	Central segment of the tornado path through Joplin, showing locations of facilities surveyed by NIST relative to the estimated center line of the tornado damage path (red solid line). The color coded building footprints indicate the estimated level of damage to individual structures (see legend above).....	83
Figure 3–3.	Easternmost segment of the tornado path through Joplin, showing locations of facilities surveyed by NIST relative to the estimated center line of the tornado damage path (red solid line). The color coded building footprints indicate the estimated level of damage to individual structures (see legend above).....	84
Figure 3–4.	Regionalization of tornado wind hazard	88
Figure 3–5.	Tornado hazard map for shelter and safe–room design	89
Figure 3–6.	Overview of St. John’s Regional Medical Center.....	93
Figure 3–7.	Time–history of wind speed and direction at north end of SJRMC.....	95
Figure 3–8.	Time–history of wind speed and direction at south end of SJRMC.	95
Figure 3–9.	SJRMC's West Tower (north side).	96
Figure 3–10.	Intact windows on fifth floor of West Tower (south side).....	98
Figure 3–11.	Intact windows on fifth floor of West Tower (north side).	98
Figure 3–12.	Damage to roof and penthouse walls of West Tower.	99
Figure 3–13.	Typical damage to the interior of West Tower.	100
Figure 3–14.	View from southwest of East Tower showing that most windows on south and west sides of building and curtain walls on connecting elevator steel frame have broken.	102
Figure 3–15.	View from southeast of East Tower showing that most windows on south and east sides of building have broken.	102
Figure 3–16.	Close–up view showing minor damage to architectural precast concrete column–cover–and–spandrel system and significant damage to glass windows of East Tower.	103
Figure 3–17.	Missing/collapsed vertical insulated metal curtain wall panels of East Tower penthouse.	104
Figure 3–18.	Damage to roof covering system of East Tower (peeling–off of EPDM roof membrane and rigid insulation, loss/displacement of roof aggregate ballast).....	105
Figure 3–19.	Overview of West, East, and Elevator Towers and Oncology Clinic Building showing that most of the aggregates that were used as roof ballast on these buildings are missing.	106

Figure 3–20.	View from northwest of Emergency Generator Building. Note northward and eastward direction of wall failure, consistent with the direction of maximum wind (westerly) shown on Figure 3–7.....	107
Figure 3–21.	East side of Emergency Generator Building. Note eastward direction of failure on east wall (CMU wall falling outward, door opened, louver pushed outward). Also note louver on north wall pushed outward, consistent with direction of maximum westerly wind and indicative of high internal pressure.....	107
Figure 3–22.	Failure details at Emergency Generator Building.....	108
Figure 3–23.	Views of damage sustained at the Chiller Plant.....	111
Figure 3–24.	South elevation of Oncology Clinic Building showing damage to building envelope (broken glass windows, missing window frame, missing roof decks).....	113
Figure 3–25.	Roof of Oncology Clinic Building: missing steel deck panels, gypsum board, rigid insulation, membrane, and aggregate ballast.	113
Figure 3–26.	Roof of Oncology Clinic Building: failed puddle welds connecting roof deck with supporting roof beam.	113
Figure 3–27.	In Oncology Clinic Building, interior damage to ductwork, electrical wiring, suspended ceiling, interior partition/metal stud wall, furniture. Note the aggregate from roof in the interior.....	114
Figure 3–28.	View of damage to envelope of Medical Office Building 1.....	115
Figure 3–29.	Views of (top) damage to envelope of Medical Office Building 2 and (bottom) portion of the steel frame system (bolted beam–column connection).....	117
Figure 3–30.	Evidence of debris impact causing breakage of windows at Medical Office Building 2.	118
Figure 3–31.	Roof aggregate ballast became wind–borne debris (on ground by Medical Office Building 2).	118
Figure 3–32.	Collapse of an entire brick veneer curtain wall and the supporting aluminum stud frame on the south–facing wall of Physician’s Office Building.	119
Figure 3–33.	Aerial views of Walmart in relation to the tornado damage path (red line denotes center of damage path).	121
Figure 3–34.	Aerial view of Walmart outlining southern half of building collapsed by the tornado. .	122
Figure 3–35.	Time–history of wind speed affecting Walmart north half.....	123
Figure 3–36.	Time–history of wind speed affecting Walmart south half.....	123

Figure 3–37.	Roof system (decks and joists) missing. Some roof joists displaced upward (top chords used to be at same elevation as top chords of joist girders, but now sitting above joist girders), showing evidence of wind uplift action as primary cause of failure.	126
Figure 3–38.	Large area of roof system shown missing. Joist girders bent upward due to uplift pressure.	126
Figure 3–39.	Missing door and glass panels and damage to signage at south entrance on west wall (envelope failure allowing air infiltration to the interior and causing increased wind uplift)	127
Figure 3–40.	Collapsed east wall due to loss of roof lateral bracing and inward wind pressure.	130
Figure 3–41.	Typical loading and design conditions for BTS building and possible failure mode.	131
Figure 3–42.	Aerial views of Home Depot in relation to the tornado damage path (red line denotes center of damage path).....	131
Figure 3–43.	Time–history of wind speed and direction affecting Home Depot.	132
Figure 3–44.	Typical connection between the roof system and the perimeter tilt–up RC wall	133
Figure 3–45.	Typical connection between roof joist girder and interior column	133
Figure 3–46.	Positive wall–to–footing connection (dowels connection to footing and concrete block, in 9 tilt–up wall panels near loading dock)	135
Figure 3–47.	Friction–only wall–to–footing connection (in remaining 64 tilt–up RC wall panels)....	135
Figure 3–48.	Roof framing schedule and typical roof joist–to–wall panel welded connection	135
Figure 3–49.	Collapsed Home Depot building (view from the northwest).....	137
Figure 3–50.	Ten tilt–up panels in the northeast corner remained standing. Seven of these 10 panels had positive connections to the footing and thus some degree of restraint against rotation. The other three uncollapsed panels had friction–only connections to the footing but appeared to have been supported against falling outward by steel shelving on the exterior side (Garden Center).....	137
Figure 3–51.	Damaged joist girders and interior columns. Note the complete loss of the roof system that was connected to the girders.	139
Figure 3–52.	Aerial views of Joplin East Middle School in relation to the tornado damage path (red line denotes center of damage path).....	140
Figure 3–53.	Center diagram shows the sections of the Joplin East Middle School building complex. The Gymnasium (A) and Auditorium (B) sustained the greatest damage in the tornado.	141
Figure 3–54.	Time–history of wind speed and direction at the south end of Joplin East Middle School (over the Gymnasium).	142

Figure 3–55.	Lateral bracing for Gymnasium walls.....	144
Figure 3–56.	Joplin East Middle School Gymnasium building, viewed from the west, showing complete loss of steel roof deck, disconnection and collapse of the first two bow–string steel trusses, and collapse of 9 out of 11 tilt–up panels of the west wall.....	144
Figure 3–57.	Disconnection of steel roof deck of Gymnasium due to failure of puddle welds due to uplift pressure.	145
Figure 3–58.	Collapsed bow–string roof trusses and collapsed west wall tilt–up panels in the interior of the Gymnasium.	146
Figure 3–59.	Seat angle welded to end of bow–string roof truss and embedded into top of tilt–up panel got disconnected. Note missing vertical headed studs (4, each 10 in. long), which appeared to have been sheared off from the angle. The three horizontal studs remained connected to the seat angle but pulled out from the concrete.	146
Figure 3–60.	Elevation showing first two bow–string roof trusses and collapse radius of west wall..	148
Figure 3–61.	View from east of Auditorium building.....	150
Figure 3–62.	In wreckage of Auditorium, missing roof deck from top of joist—only puddle–weld marks remained.....	150
Figure 3–63.	Collapse due to overturning (outward) of east perimeter Joplin East Middle School Auditorium wall after loss of roof diaphragm.	151
Figure 3–64.	Overview of Joplin High School complex, with estimated center line of Joplin tornado damage path shown in red.....	152
Figure 3–65.	Estimated time–history of wind speed and direction at southeast corner (closest to center of tornado damage path) of Joplin High School.	153
Figure 3–66.	View from the exterior showing damage to the envelope of one of the RC frame buildings (east building) of Joplin High School.	154
Figure 3–67.	View from the exterior showing damage to the envelope of one of the RC frame buildings (west building) of Joplin High School.	154
Figure 3–68.	Damage and debris in an interior hallway of Joplin High School.	155
Figure 3–69.	View from west of the Joplin High School Gymnasium building.	156
Figure 3–70.	View from north of the Joplin High School Auditorium building.....	157
Figure 3–71.	Failure of joist–to–CMU wall connection due to uplift.....	157
Figure 3–72.	Collapse of CMU wall due to loss of lateral roof bracing.	158
Figure 3–73.	Short anchorage between CMU wall and concrete footing.	158

Figure 3–74.	Overview of damage at Franklin Technology Center, with center line of tornado damage path (in red).....	160
Figure 3–75.	Estimated time–history of wind speed at southeast corner of Franklin Technology Center.....	161
Figure 3–76.	Steel roof deck and roof joist connection to CMU wall bond beam.....	161
Figure 3–77.	Steel roof joists, with missing roof decks, remained connected to CMU bond beam. Bond beam remained continuous, but was disconnected from the CMU walls along the bond line between the two CMU courses at the top of the wall.	162
Figure 3–78.	Perimeter CMU wall that collapsed after loss of roof lateral bracing (note lack of reinforcing dowels connecting wall to concrete footing).....	163
Figure 3–79.	Perimeter CMU wall that collapsed after loss of roof lateral bracing (note lack of reinforcing dowels connecting wall to concrete footing).....	163
Figure 3–80.	Overview of damage at St. Mary’s Catholic Elementary School, with estimated center line of tornado damage path shown in red.	165
Figure 3–81.	Estimated time–history of wind speed affecting the buildings at St. Mary’s Catholic Elementary School.	166
Figure 3–82.	Section of building at St. Mary’s Catholic Elementary school with complete loss of the steel roof system.	166
Figure 3–83.	Section of building at St. Mary’s Catholic Elementary school with collapsed perimeter CMU walls.....	166
Figure 3–84.	Overview of damage to the Ozark Center for Autism and surrounding buildings, with estimated center line of tornado damage path shown in red.	170
Figure 3–85.	Estimated time–history of wind speed and direction at the Ozark Center.	171
Figure 3–86.	Ozark Center for Autism building (viewed from the southeast).....	172
Figure 3–87.	Interior view of the physical education section of the Ozark Center showing structural system with roof truss–column moment connection and open–web roof joist and wide–rib steel roof deck.	172
Figure 3–88.	Significant damage to the envelope and minor damage to the MWFRS of the physical education section of the Ozark Center building, including (1) loss of part of steel roof decks, (2) loss of all insulating windows and steel frames on all wind–exposed sides, and (3) deformation of steel beam (likely due to debris impact).....	174
Figure 3–89.	Typical damage to the Ozark Center building envelope (broken window glazing, missing window frames, and torn exterior steel panels).	174
Figure 3–90.	Overview of damage at St. Paul’s United Methodist Church and surrounding areas, with the estimated center line of the tornado damage path shown in red.	176

Figure 3–91.	Estimated time–history of wind speed affecting the Mass Hall of St. Paul’s United Methodist Church.	177
Figure 3–92.	View from east of the damaged, pre–engineered steel Mass Hall building of St. Paul’s United Methodist Church.....	177
Figure 3–93.	Tapered rafter sections with bolted connection and roof purlins of St. Paul’s United Methodist Church.	178
Figure 3–94.	Damage to envelope of St. Paul’s United Methodist Church.	178
Figure 3–95.	Overview of damage at the Ramesh Shah Ophthalmology Center, with the estimated center line of the tornado damage path shown in red.	180
Figure 3–96.	Estimated time–history of wind speed and direction at the Ramesh Shah Ophthalmology Center.....	181
Figure 3–97.	Ramesh Shah Ophthalmology Center viewed from the southwest.....	181
Figure 3–98.	Ramesh Shah Ophthalmology Center viewed from the east–southeast.....	182
Figure 3–99.	Close up view of the Ramesh Shah Ophthalmology Center showing connections and cable bracing of the pre–engineered steel frames.....	182
Figure 3–100.	Close up view of the Ramesh Shah Ophthalmology Center showing connection between the pre–engineered steel frame with the concrete wall below.....	183
Figure 3–101.	References for Joplin GIS database damage classifications and coding: light (green), medium (yellow), heavy/totalled (orange), and demolished (red).....	186
Figure 3–102.	Overview of the Greenbriar Nursing Home, shown in relation to the estimated center line of the tornado damage path (red line).....	188
Figure 3–103.	Estimated time–history of wind speed affecting the Greenbriar Nursing Home.	189
Figure 3–104.	Collapsed Greenbriar Nursing Home (viewed from the east) with missing roof system and collapsed exterior CMU walls. Note debris from building materials as well as other sources (automobiles) in all interior areas of the facility.....	189
Figure 3–105.	Collapsed Greenbriar Nursing Home.....	190
Figure 3–106.	Collapsed Greenbriar Nursing Home (viewed from the north) showing the portion of the north wing’s exterior wall that did not collapse.....	190
Figure 3–107.	Overview of the Mercy Village Apartments, shown in relation to the estimated center line of the tornado damage path (red line). SJRMC is located to the west (left) of the apartments.....	192
Figure 3–108.	Estimated time–history of wind speed affecting the Mercy Village Apartments.	193

Figure 3–109.	Hurricane tie-downs connecting wood roof trusses to load-bearing wood-frame wall.	194
Figure 3–110.	L to R, pre-deflected wall hold-down, steel strap, and wall anchor.	195
Figure 3–111.	Mercy Village Apartments, viewed from the north, with envelope damage (siding, window glazing, roof covering).	196
Figure 3–112.	Damage to the building envelope of the Mercy Village Apartments.	196
Figure 3–113.	Residential failure due to disconnection of entire roof system (roof-to-wall connection failure due to wind uplift).	199
Figure 3–114.	Failure of first-story-to-foundation wall connection. Entire roof and first floor shifted off of lower story (directly north of SJRMC).	200
Figure 3–115.	Disconnection and loss of entire roof system.	201
Figure 3–116.	Typical roof-to-wall connection damage.	201
Figure 3–117.	Typical wall-to-foundation connections.	202
Figure 3–118.	Typical damage to residential dwelling envelope.	202
Figure 3–119.	Aerial photo showing the locations of the designated refuge area and TBO area in the Walmart store, and a drawing containing the refuge area.	205
Figure 3–120.	Location of the Training Room/designated refuge area at the Home Depot. Perimeter tilt-up wall panels here collapsed inward and onto the safe area.	207
Figure 3–121.	North section of the Home Depot. Red line indicates perimeter tilt-up wall panels that collapsed. Yellow line traces perimeter tilt-up wall panels (northeast corner, around loading dock) that did not collapse. Red rectangle designates the Training Room/designated refuge area.	208
Figure 3–122.	View, from outside toward the west, of the Training Room/designated refuge area of the Home Depot.	209
Figure 3–123.	Locations of Tornado Safe Shelters (color blocks) in Joplin East Middle School and their associated, pre-planned tornado evacuation routes (arrows of corresponding color). ...	211
Figure 3–124.	Locations of “storm shelters” at Joplin High School and pre-planned emergency evacuation routes.	212
Figure 3–125.	Locations of areas of refuge (AOR, red blocks) on the first floor of the Ozark Center for Autism building.	214
Figure 3–126.	View of a typical hallway with damaged interior (ceiling, walls, and debris); hallways were used as designated refuge areas in SJRMC’s East and West Towers.	216

Figure 3–127.	Typical floor plan of SJRMC’s East and West Towers (patient rooms along perimeter and hallway toward the center).....	216
Figure 3–128.	Wood–frame home completely destroyed except for the steel shelter bolted to the concrete floor in the garage.....	220
Figure 3–129.	Above–ground Kevlar storm shelter bolted to concrete garage floor in residence that was damaged during the Joplin tornado.....	221
Figure 3–130.	Extent of damage (roof system disconnected) at residence with in–home, above–ground Kevlar storm shelter.....	221
Figure 3–131.	Destroyed EDE Power Substation 59.....	227
Figure 3–132.	High–pressure gas reducer valve at SJRMC that was damaged and leaked.....	229
Figure 3–133.	Liquid oxygen tank at SJRMC that leaked.....	229
Figure 4–1.	Model #2001–130 Siren from the Federal Signal Company.....	244
Figure 4–2.	Siren locations for the City of Joplin.....	244
Figure 4–3.	The polygons associated with the 18 tornado warnings issued by the NWS between July 1, 2005, and May 25, 2011 (false alarms shown in red, warnings followed by verified tornadoes shown in blue).....	249
Figure 4–4.	Locations of the 161 fatalities resulting from the Joplin tornado. Tornado estimated center track plotted in red.....	255
Figure 4–5.	Joplin Elks Lodge #501 destroyed by the Joplin tornado.....	257
Figure 4–6.	Damage to the interior of SJRMC.....	259
Figure 4–7.	The small brick wall in the foreground (to the left of the van) is one of the few portions of the Greenbriar Nursing Home left standing following the Joplin tornado. (The building standing in the background was not part of the Greenbriar.).....	264
Figure 4–8.	Locations of places of worship, denoted by black plus signs (+) where people died and yellow circles where there were no fatalities, along the tornado damage path (red line marks the estimated center track of the path).....	265
Figure 4–9.	The AT&T store following the Joplin tornado.....	268
Figure 4–10.	A view of the Home Depot building that collapsed in the Joplin tornado.....	271
Figure 4–11.	Damage to Dillon’s grocery inflicted by the Joplin tornado.....	274
Figure 4–12.	Aerial photo of the tornado–damaged Walmart Store #59, showing the collapsed south half and uncollapsed north half of the building.....	276

Figure 4–13.	Geographic locations of 104 of the 109 NIST interviewees who were located at home when the tornado hit Joplin. The red line indicates the estimated center track of the tornado.	277
Figure 4–14.	Demolished home located within the tornado damage path in Joplin.	285
Figure 4–15	The geographic locations of deaths in homes and apartments in Joplin. Detached homes are designated by pentagon shapes and apartments by square shapes, with the red line indicating the estimated center track of the tornado.	286
Figure 4–16.	Geographic locations of NIST interviewees located outside of structures when the storm hit (13 individuals were in vehicles and 2 were outdoors). The red line represents the estimated center track of the tornado. Note: Two interviewees were located slightly beyond the boundaries of the aerial photograph; their locations are shown to scale	297
Figure 4–17.	The geographic locations of deaths that occurred in vehicles (indicated by the red and blue highway signs) and outdoors (black diamonds) when the storm hit. The red line is the estimated center track of the tornado. Note: Multiple deaths occurring at the same location are represented by only one symbol.....	291
Figure 4–18.	Comparison, by age, of the 161 Joplin fatalities with U.S. tornado fatalities from 1996 through 2007 (Simmons and Sutter 2011).	296
Figure 4–19.	Comparison of fatality rates per thousand people within two populations: Population 1 – the entire population of Joplin and Population 2 – the population of the areas within Joplin most affected by the tornado (U.S. Census Bureau 2010).	297
Figure 4–20.	Census tracts in Joplin that were affected by tornado damage.	297
Figure 4–21.	Tornado–related injury rates by 10–year age range for residents of Jasper and Newton Counties (U.S. Census Bureau 2010).	298
Figure 4–22.	Geographic locations of the 154 fatalities (in red) and 35 severely injured persons (in blue) included in this analysis.....	302
Figure 4–23.	Geographic locations (labeled by name of structure or type of setting) of the 154 fatalities and 35 severely injured persons included in the analysis of impact–related deaths and severe injuries.	302
Figure 4–24.	The location of the five EF–Scale polygons overlaid on the aerial photo of the estimated tornado center track (red line).	304
Figure 4–25.	Overhead view of tornado damage to Walmart Store #59.	306
Figure 4–26:	A sample of the Jasper County GIS database damage levels distinguished by color.	308
Figure 4–27.	Aerial photo showing the AT&T store demolished by the storm (outlined in red).	310
Figure 4–28.	Tornado damage to the Joplin Elks Lodge.....	311
Figure 4–29.	Aerial photo showing damage to the Full Gospel Church building.....	311

Figure 4–30.	Aerial photo showing damage to Harmony Heights Baptist Church.....	312
Figure 4–31.	Aerial photo showing damage to the Joplin Pizza Hut.	312
Figure 4–32.	Aerial photo showing damage to the Stained Glass Theater.	313
Figure 4–33.	Aerial photo showing damage to the Meadows Healthcare facility (outlined in red)....	314
Figure 4–34.	Aerial photo showing damage to Walmart Store #59, including the red box (circled in white) to indicate the store’s refuge area.	315
Figure 4–35.	Aerial photo showing damage to the Home Depot (outlined in red).	316
Figure 4–36.	Damage to the interior of SJRMC.	317
Figure 4–37.	Aerial photo showing damage to two apartment complexes in Joplin at 2001 Connecticut Avenue (outlined by solid red line) and 2034 Connecticut Avenue (within dotted line).....	321
Figure 4–38.	Aerial photo showing damage to the Hampshire Terrace apartments.	322
Figure 4–39.	Aerial photo showing damage to the Greenbriar Nursing Home.....	323
Figure 4–40.	Graphic showing the location of all 154 impact–related fatalities in relation to the EF wind speed zones (red = EF–4, orange = EF–3, yellow = EF–2, green = EF–1, and blue = EF–0).	326
Figure 4–41.	A model depicting protective–action decision–making in the Joplin tornado.....	328
Figure 4–42.	Tornado fatality rates per thousand people within two populations: Population 1 – the entire population of Joplin and Population 2 – the population of the areas within Joplin most affected by the tornado (154 impact–related deaths)	331
Figure 4–43.	Tornado fatality rates (154 impact–related fatalities) and Residential tornado fatality rates (single–family homes and apartments, only)	332
Figure D–1.	Main (top) and interaction (bottom) effects plots for input and output parameters.....	380
Figure D–2.	Histograms showing values of DW and DR for X = 2.1 miles.....	382
Figure D–3.	Area and grid point for detailed factorial design (left)	383
Figure D–4.	Interaction effects plots for DW (top) and DR (bottom) for X = 2.1 miles.	384
Figure D–5.	Interaction effects plots for $\theta = 90$ degrees (top) and $\theta = 180$ degrees (bottom) for X = 2.1 miles.....	385
Figure E–1.	Time History for Near WalMart (Grid Point # 3429).....	387
Figure E–2.	Time History for Near Franklin Technology Center (Grid Point # 1862)	388

Figure E-3.	Time History for Near Home Depot (Grid Point # 3344).....	389
Figure E-4.	Time History for Near St. John’s Regional Medical Center –Main Buildings (Grid Point # 853).....	390
Figure E-5.	Time History for Near Joplin East Middle School (Grid Point # 4382).....	391
Figure E-6.	Time History for Near Joplin High School (Grid Point # 1942).....	392
Figure F-1.	Map of EF-0 tornadoes per year.....	393
Figure F-2.	Map of EF-1 tornadoes per year.....	394
Figure F-3.	Map of EF-2 tornadoes per year.....	394
Figure F-4.	Map of EF-3 tornadoes per year.....	395
Figure F-5.	Map of EF-4 tornadoes per year.....	395
Figure F-6.	Map of EF-5 tornadoes per year.....	396
Figure H-1.	Wind pressure distribution for the Walmart building.....	404
Figure I-1.	Wind pressure distribution for MWFRS of the Home Depot building.....	406
Figure J-1.	Wind pressure distribution along length of the Joplin East Middle School Gymnasium.....	414
Figure J-2.	Wind pressure distribution on the cross section of the Joplin East Middle School Gymnasium.....	414

LIST OF TABLES

Table E-1.	Summary of NIST recommendations	lvi
Table 2-1.	Enhanced Fujita Scale.....	35
Table 2-2.	Estimated wind speeds for NIST-surveyed structures using EF Scale.....	37
Table 2-3.	Wind speed statistics and numbers of structures estimated for residential damage levels using EF Scale.	38
Table 2-4.	Observed Joplin tree fall metrics.	46
Table 2-5.	Estimated areas affected by wind speeds falling within the EF wind-speed ranges, within Joplin grid system and in theoretical EF-4 and EF-5 tornadoes.....	52
Table 2-6.	NIST best estimate of maximum wind speeds for NIST-surveyed structures using tornado wind field model and EF Scale.....	55
Table 2-7.	Percentage of tornado-affected areas exhibiting EF-3 or greater damage, given damage occurs and given specified tornado rating.....	60
Table 2-8.	Sample of significant tornado events in Joplin region.....	66
Table 3-1.	Summary of building-related losses from the Joplin tornado.	78
Table 3-2.	List of NIST-surveyed buildings with damage condition and design information.	81
Table 3-3.	Summary of significant changes in codes and standards pertaining to wind design.	87
Table 3-4.	History of code adoptions and amendments relevant to wind design by the City of Joplin, Missouri.	90
Table 3-5.	Distribution of tornado-affected residential structures by level of damage sustained and year built.	195
Table 3-6.	Correlation between degree of damage and age of residential construction, by severity of wind speed.	198
Table 3-7.	Timeline of Electrical Power Restoration.....	225
Table 4-1.	Distribution of fatalities based upon location of injury/death from the Joplin tornado listed in alphabetical order by location name.....	253
Table 4-2.	Distribution of injured persons based upon locations of sampled injuries and all fatalities from the Joplin tornado.....	256

Table 4–3.	Number of impact–related fatalities by location (of death or injury that led to death) resulting from the Joplin tornado.	300
Table 4–4.	Distribution of 35 severely injured persons (from the CDC sample) based upon the locations where they were injured in the Joplin tornado.	301
Table 4–5.	Wind speeds associated with fatalities and severe injuries among people located outside of buildings.	305
Table 4–6.	Details on the wind environment, building type, building damage, and actions taken by the deceased for seven buildings in which people died in the Joplin tornado.	309
Table 4–7.	Details on the fatalities, wind environment, building type, building damage, and actions taken by the deceased for residential buildings impacted by the Joplin tornado.	319
Table 4–8.	Wind speeds associated with impact–related fatalities and severe injuries – all locations.	324
Table 4–9.	Impact–related fatalities and severe injuries by distance from the tornado estimated center track.	325
Table D–1.	Final input parameter ranges.	381
Table G–1.	City of Joplin Code Adoptions.	397
Table H–1.	Net internal pressure and internal suction for the Walmart building.	403
Table I–1.	Net internal pressure and internal suction for MWFRS of the Home Depot building.	406
Table J–1.	Wind pressure acting on the MWFRS of the Joplin East Middle School gymnasium.	413
Table K–1.	The number of qualifying community emergency management websites chosen, by State.	415

LIST OF ACRONYMS AND ABBREVIATIONS

Acronyms

ACI	American Concrete Institute
AHJ	authority having jurisdiction
AISC	American Institute of Steel Construction
ANS	American Nuclear Society
ANSI	American National Standards Institute
ASCE	American Society of Civil Engineers
ASOS	automated surface observing system
AWS	American Welding Society
BOCA	Building Officials and Code Administrators
BTS	box-type system
CAPE	convective available potential energy
CDC	U.S. Centers for Disease Control and Prevention
CIP	cast-in-place
CMAS	Commercial Mobile Alert System
CMU	concrete masonry unit
COV	coefficient of variation
DHS	U.S. Department of Homeland Security
DHS IP	DHS Office of Infrastructure Protection
DHS S&T	DHS Science and Technology Directorate
DI	damage indicator
DOD	degree of damage
DOE	U.S. Department of Energy
DR	damage ratio
DW	damage width
EAS	Emergency Alert System
EDE	Empire District Electric
EF Scale	Enhanced Fujita Scale
EM	emergency manager

EOC	emergency operations center
EPDM	ethylene propylene diene monomer
FCC	Federal Communications Commission
FEMA	Federal Emergency Management Agency
F Scale	Fujita Scale
FY	fiscal year
GIS	geographic information system
IBC	International Building Code
ICC	International Code Council
ICU	intensive care unit
IRC	International Residential Code
MAW	Missouri American Water Company
MCD	Mesoscale Convective Discussion
MDHSS	Missouri Department of Health and Senior Services
MGE	Missouri Gas Energy
MOB	medical office building
MRH	mean roof height
MRI	mean recurrence interval
MSSU	Missouri Southern State University
MWFRS	main wind–force resisting system
NBC	National Building Code
NCST	National Construction Safety Team
NEMA	National Emergency Management Association
NFPA	National Fire Protection Association
NIST	National Institute of Standards and Technology
NOAA	National Oceanic and Atmospheric Administration
NRC	U.S. Nuclear Regulatory Commission
NSF	National Science Foundation
NWR	NOAA weather radio
NWS	National Weather Service
OFCM	Office of the Federal Coordinator for Meteorological Services and Supporting Research
OSTP	Office of Science and Technology Policy

PCA	Portland Cement Association
PCI	Precast/Prestressed Concrete Institute
PE	physical education
PEMB	pre-engineered metal building
PSDA	post-storm data acquisition
QRT	quick response team
RC	reinforced concrete
RG	Regulatory Guide
RMW	radius of maximum wind
SDI	Steel Deck Institute
SEAKM	Structural Engineers Association of Kansas and Missouri
SF	steel frame
SJI	Steel Joist Institute
SJRMC	St. John's Regional Medical Center
SPC	Storm Prediction Center
TBO	tire and battery operation
TMS	The Masonry Society
TO.W	tornado warning
URM	unreinforced masonry
UTC	Coordinated Universal Time
WFO	weather forecast office

Abbreviations

ft	foot
ft ²	square foot
in.	inch
J/kg	joules per kilogram
kg	kilogram
kip	a force equal to 1,000 pounds
km	kilometer
km ²	square kilometer
lb	pound

lb/ft ²	pounds per square foot
m	meter
mb	millibar
min	minute
mph	miles per hour
m/s	meters per second
Pa	pascal
plf	pounds per linear foot
psf	pounds per square foot
s	second

METRIC CONVERSION TABLE

To convert from	to	Multiply by
AREA AND SECOND MOMENT OF AREA		
square foot (ft ²)	square meter (m ²)	9.290 304 E-02
square inch (in. ²)	square meter (m ²)	6.4516 E-04
FORCE		
kilogram-force (kgf)	newton (N)	9.806 65 E+00
kilopond (kilogram-force) (kp)	newton (N)	9.806 65 E+00
kip (1 kip=1,000 lbf)	newton (N)	4.448 222 E+03
kip (1 kip=1,000 lbf)	kilonewton (kN)	4.448 222 E+00
pound-force (lbf)	newton (N)	4.448 222 E+00
FORCE DIVIDED BY LENGTH		
pound-force per foot (lbf/ft)	newton per meter (N/m)	1.459 390 E+01
pound-force per inch (lbf/in.)	newton per meter (N/m)	1.751 268 E+02
LENGTH		
foot (ft)	meter (m)	3.048 E-01
inch (in)	meter (m)	2.54 E-02
MASS and MOMENT OF INERTIA		
kilogram-force second squared per meter (kgf · s ² /m)	kilogram (kg)	9.806 65 E+00
pound foot squared (lb · ft ²)	kilogram meter squared (kg · m ²)	4.214 011 E-02
pound inch squared (lb · in. ²)	kilogram meter squared (kg · m ²)	2.926 397 E-04

To convert from	to	Multiply by
PRESSURE or STRESS (FORCE DIVIDED BY AREA)		
kilogram–force per square centimeter (kgf/cm ²)	pascal (Pa)	9.806 65 E+04
kilogram–force per square meter (kgf/m ²)	pascal (Pa)	9.806 65 E+00
kilogram–force per square millimeter (kgf/mm ²)	pascal (Pa)	9.806 65 E+06
kip per square inch (ksi) (kip/in. ²)	pascal (Pa)	6.894 757 E+06
kip per square inch (ksi) (kip/in. ²)	kilopascal (kPa)	6.894 757 E+03
pound–force per square foot (lbf/ft ²)	pascal (Pa)	4.788 026 E+01
pound–force per square inch (psi) (lbf/in. ²)	pascal (Pa)	6.894 757 E+03
pound–force per square inch (psi) (lbf/in. ²)	kilopascal (kPa)	6.894 757 E+00
psi (pound–force per square inch) (lbf/in. ²)	pascal (Pa)	6.894 757 E+03
psi (pound–force per square inch) (lbf/in. ²)	kilopascal (kPa)	6.894 757 E+00
VELOCITY (includes SPEED)		
foot per second (ft/s)	meter per second (m/s)	3.048 E–01
kilometer per hour (km/h)	meter per second (m/s)	2.777 778 E–01
mile per hour (mi/h)	kilometer per hour (km/h)	1.609 344 E+00
mile per minute (mi/min)	meter per second (m/s)	2.682 24 E+01

EXECUTIVE SUMMARY

E.1 INTRODUCTION

Tornadoes typically affect much smaller geographic areas compared with other natural hazards like earthquakes and hurricanes, but occur at a much higher frequency and cause more deaths than those two hazards combined. The May 22, 2011, Joplin tornado, rated EF-5 on the Enhanced Fujita tornado intensity scale, was one of the estimated 1,691 tornadoes that occurred in the United States in 2011.¹ During the period from 1950 (the beginning of official tornado record keeping) through 2011, U.S. tornadoes caused about 5,600 fatalities.² This number well exceeds the toll for U.S. hurricanes and earthquakes over the same period (3,102¹ and 459,³ respectively).

The Joplin tornado caused 161 fatalities and more than 1,000 injuries, making it the deadliest single tornado on record in the official U.S. tabulations begun in 1950.¹ It was a record tornado that occurred in a year of record U.S. tornado activity and impacts. To put the Joplin tornado's death toll into perspective, the 161 fatalities that resulted from it (out of the total of 553 U.S. tornado deaths in 2011) were almost twice the national average of 91.6 tornado fatalities per year (since 1950), more than three times the average of 50.8 hurricane deaths per year, and more than twenty times the average of 7.5 earthquake fatalities per year. The Joplin tornado's high death toll occurred despite an official tornado warning time of about 17 minutes⁴, greater than the National Weather Service (NWS) national average warning time of approximately 14 minutes.⁵

The Joplin tornado also was a record-setter in terms of damage to the built environment and economic loss. It was on the ground for about 22 miles (6 miles within the City of Joplin) and 15 minutes, long enough to severely damage well-developed commercial and residential areas in Joplin that were home to about 41 percent of the city's population (20,820 people, out of the 50,175 estimated to reside in Joplin in 2010⁶). The resulting damage to the built environment (not counting losses due to business disruption) was the costliest on record for a tornado, with insured losses initially estimated to be as high as \$3 billion.⁷ Nearly a year after the storm, the City of Joplin, quoting data provided by the Missouri Department of Insurance, Financial Institutions, and Professional Registration, reported that insured commercial property losses had reached \$1.228 billion and residential property losses were at \$0.552 billion.⁸

¹ NOAA (www.noaa.gov/2011_tornado_information.html).

² NWS (www.nws.noaa.gov/om/hazstats/resources/weather_fatalities.pdf).

³ Deaths from U.S. Earthquakes (http://earthquake.usgs.gov/earthquakes/states/us_deaths.php).

⁴ The first set of sirens were initiated 23 minutes before official touchdown; however, this siren initiation was based upon a different storm to the north of Joplin that never produced a tornado.

⁵ NWS average for 2008 (www.nws.noaa.gov/cfo/program_planning/doc/FY-2009%20NOAA's%20NWS%20National%20Performance%20Measures%20-%20Graph%20Update.pdf).

⁶ United States Census Bureau (www.census.gov/newsroom/emergencies/2011_tornadoes.html).

⁷ According to a preliminary loss estimate issued by EQECAT (www.eqecat.com/catWatchREV/secureSite/report.cfm?id=321).

⁸ City of Joplin (www.joplintornadoanniversary.com/resources/city-of-joplin-factsheet5-14-12.pdf).

The majority of the Joplin tornado fatalities (83.8 percent, or 135 of the 161 deaths) occurred inside buildings. In all, about 553 non-residential buildings, comprising types of structures commonly found in U.S. cities, were severely damaged in the Joplin tornado, including 1 of the 2 major hospitals serving the City of Joplin, 10 of the 20 local public schools, several parochial schools, 28 churches, 2 fire stations, and both large and small commercial facilities. The storm also damaged nearly 7,500 residential structures, from single-family homes to large apartment buildings.⁹ The high death toll occurred in buildings of varying types, despite a relatively generous warning time in a city with a long history of adopting the latest model building codes. This brings into question the effectiveness of current U.S. tornado warning systems and practices, and whether building safety in tornadoes can be enhanced, given that current national building standards, codes, and practices do not require buildings to be built to withstand tornadoes or to include tornado shelters or safe rooms.¹⁰

Disasters such as the Joplin tornado provide unfortunate but important opportunities to learn from the performance of structures, emergency communications, and human behavior during catastrophic events. Insight gained from such learning can lead to improvements in standards, codes, and practices that will reduce losses and improve safety in future events. This report documents the findings and recommendations resulting from the technical investigation of the May 22, 2011, Joplin tornado undertaken by the U.S. Commerce Department's National Institute of Standards and Technology (NIST).¹¹

E.2 NIST RESPONSE AND SCOPE OF THE TECHNICAL INVESTIGATION

NIST began assessing the Joplin tornado and its associated impacts in the immediate aftermath of the disaster. Based on initial information about the human toll of the storm and its impact on buildings and other structures, NIST deployed a four-person reconnaissance team to collect perishable data and to make a recommendation about whether a more detailed study was warranted. This team, which included NIST researchers with expertise in structural and fire engineering, extreme wind, and sociology, deployed to Missouri on May 24, 2011, two days after the tornado struck, and conducted field reconnaissance in Joplin May 25–28, 2011.¹²

The NIST reconnaissance team determined, based on its analysis of the data collected during the reconnaissance, that this event provided a significant opportunity to learn from what happened and to improve safety in the future. On June 29, 2011, NIST Director Patrick Gallagher—by implementing legislative authority provided in the National Construction Safety Team Act (NCST)¹³—established a NCST Team to conduct a detailed technical investigation of the May 22, 2011, Joplin tornado. The establishment of the NCST Team was announced in the Federal Register on July 19, 2011 (76 FR 42683).

⁹ Joplin Area Chamber of Commerce (<http://regionalpartnership.contros.com/JACC%20Fact%20Sheet%205-1-12.pdf>).

¹⁰ The City of Joplin, like most other municipalities in tornado high-hazard areas and like the contemporaneous model building codes, did not mandate the construction of shelters or safe rooms in residential or commercial facilities at the time of the May 22, 2011, Joplin tornado.

¹¹ NIST is a non-regulatory agency of the Department of Commerce.

¹² See www.nist.gov/el/disasterstudies/upload/Joplin_Reconnaissance_Presentation061511-2.pdf for more information about NIST's preliminary reconnaissance in Joplin.

¹³ Public Law 107-231, October 1, 2002, 116 Stat. 1471 (15 U.S.C. 7301 et seq.). information about the NCST is available at www.nist.gov/el/disasterstudies/ncst/aboutncst.cfm.

The NCST Team consisted of four researchers from NIST's Engineering Laboratory¹⁴ with expertise in structural and fire engineering, extreme wind, and sociology (human behavior and emergency response). In addition to the NIST researchers, a researcher with expertise in meteorology and severe storms and warnings from the National Oceanic and Atmospheric Administration's National Severe Storms Laboratory was also named as part of the NCST Team.

The scope of the investigation of the Joplin tornado included analyses of the wind environment and technical conditions that may have contributed to the fatalities and injuries, the performance of emergency communications systems, the public's response to emergency communications, and the performance of buildings and lifelines. The primary outcomes (findings and recommendations) of the NIST technical investigation provide a technical basis for improved codes, standards, and practices related to tornado hazard characterization, tornado-resilient design and construction, emergency communications systems, and emergency response. It is anticipated that the findings and recommendations in this report will contribute to the voluntary consensus process that is used to develop U.S. codes, standards, and practices.

The goals of the NCST technical investigation of the May 22, 2011, Joplin tornado were:

- To investigate the wind environment and technical conditions associated with fatalities and injuries, the performance of emergency communications systems and the public response to such communications, and the performance of residential, commercial, and critical buildings, designated safe areas in buildings, and lifelines.
- To develop findings and recommendations that can serve as the basis for
 - Potential improvements to requirements for design and construction of buildings, designated safe areas, and lifeline facilities in tornado-prone regions;
 - Potential improvements to guidance for tornado warning systems and emergency response procedures;
 - Potential revisions to building, fire, and emergency communications codes, standards, and practices; and
 - Potential improvements to public safety.

To achieve those goals, five specific NCST technical investigation objectives were identified:

1. Determine the tornado hazard characteristics and associated wind fields in the context of historical data
2. Determine the response of residential, commercial, and critical buildings, including the performance of designated safe areas

¹⁴ NIST's Engineering Laboratory supports U.S. industry and public safety by providing critical tools—metrics, models, and knowledge—and the technical basis for standards, codes, and practices.

3. Determine the performance of lifelines as it relates to the continuity of operations of residential, commercial, and critical buildings
4. Determine the pattern, location, and cause of fatalities and injuries, and associated emergency communications and public response
5. Identify, as specifically as possible, areas in current building, fire, and emergency communications codes, standards, and practices that warrant revision

E.3 THE HAZARD CONTEXT

In the days leading up to the May 22, 2011, Joplin tornado, forecasters at the National Weather Service (NWS) Storm Prediction Center (SPC) were becoming more certain about the impending occurrence of a significant weather event; one that would include thunderstorms and possible tornadoes, in a region that encompassed Joplin, Missouri. Given their location in “tornado alley,” residents in the vicinity of Joplin were no strangers to tornadic activity. According to the SPC, from 1950 through 2011, the area within an 80-mile radius of Joplin encountered a total of 766 tornadoes (of which 6 percent were rated EF-3 or higher), or an average of 12.5 tornadoes per year. A total of 182 tornadoes rated EF-2 or greater struck the region during this period.

On Sunday, May 22, 2011, forecaster confidence in a severe weather event grew, and the SPC issued a tornado watch for Joplin and surrounding communities at 3:00 p.m. Although conditions required for thunderstorms were present in the region, the conditions in Joplin were relatively quiescent at this time. At 4:33 p.m., NWS forecasters in Springfield, Missouri, briefed the Joplin–Jasper County Emergency Manager (EM) on severe storms to the west (NWS Service Assessment). At 5:09 p.m., a tornado warning was issued for a storm cell affecting the northeast part of Joplin. At 5:11 p.m., the Joplin–Jasper County EM sounded the tornado sirens throughout Joplin. The decision to sound the siren system was made by the Joplin–Jasper County EM based on conversations between emergency management personnel in Cherokee County, Kansas (immediately west of Jasper County) and Joplin–Jasper County, information received from the NWS about the impending (5:09 p.m.) warning affecting northeast Joplin, the direction of travel of the storm that was the subject of the 5:09 warning, and anecdotal information from a local emergency official (outside of Joplin) regarding the destruction associated with that storm. This sounding caused some confusion among Joplin residents, since at this time there were few environmental clues to suggest that severe weather was imminent.

At 5:17 p.m., the NWS office in Springfield, Missouri, issued another tornado warning for a different storm which included southwest Jasper County and encompassed the entire city of Joplin. At 5:34 p.m., an emergency response official located in the area reported seeing a tornado touching down southwest of the Joplin city limits, and 4 minutes later, a police officer spotted the tornado entering the city. About this time, the tornado sirens were sounded for a second time in the Joplin area. The tornado followed a six-mile, roughly west-to-east path through Joplin, and was up to a mile wide in some places. At 5:48 p.m., the NWS issued a third tornado warning to extend the warning area to the east of Joplin. By 5:50 p.m., the tornado was moving out of Joplin after exacting a terrible toll in the city. The overall length of the tornado’s path was 22.1 miles.

E.4 PRINCIPAL FINDINGS

NIST developed findings based upon information collected during and after the initial reconnaissance, interviews conducted with survivors, and data analyses related to environmental conditions, building performance, and emergency response and communications activities. These findings are enumerated in Sec. E.4.2, following the contextual observations presented in Sec. E.4.1.

E.4.1 Context for Findings

- National model building codes, standards, and practices seek to achieve life safety for the hazards that are considered in design. While these considerations include hurricane and nontornadic wind, flood, snow, rain, earthquake, and ice loads, they do not include tornado hazards (loads due to wind speeds that significantly exceed code-compliant design wind speed and impacts of wind-borne debris). Thus, buildings and other structures are not designed for tornado hazards currently. The sole exceptions are safety-related structures in nuclear power plants and storm shelters or safe rooms.
- There are currently two tornado hazard maps prescribing different tornado hazard regionalization and associated wind speeds for the contiguous United States:
 - The ANSI/ANS 2.3 (2011), NRC/RG 1.76 (2007), and DOE 1020 (2002) map for designing nuclear-related facilities (three regions, 230 mph maximum wind speed); and
 - The ICC 500 (2008), FEMA 320 (2008), and FEMA 361 (2008) map for designing shelters and safe rooms (four regions, 250 mph maximum wind speed).
- Current building codes and standards prohibit the use of aggregate roof surfacing materials or ballast for hurricane-prone regions,¹⁵ but allow their use elsewhere based on mean roof height and exposure category. For the City of Joplin, the building code at the time of the May 22, 2011, Joplin tornado allowed aggregate roof ballast for buildings with a mean roof height of less than 110 ft.
- In the State of Missouri, adoption and enforcement of building codes are prerogatives of authorities having jurisdiction at the local government level. The City of Joplin's building department has a long history of code adoptions, and typically has adopted the latest national model building codes shortly after they have been issued.
- Like most other municipalities in tornado-prone areas and the contemporaneous model building codes, the City of Joplin did not mandate the construction of shelters or safe rooms in residential or non-residential facilities at the time of the May 22, 2011, Joplin tornado. Additionally, the City did not own or operate any public storm shelters. The lack of public shelters and requirements for safe rooms in residential or non-residential facilities meant that

¹⁵ Defined in ASCE/SEI Standard 7-10 *Minimum Design Loads for Buildings and Other Structures*, as: "Areas vulnerable to hurricanes; in the United States and its territories defined as (1) The U.S. Atlantic Ocean and Gulf of Mexico coasts where the basic wind speed for Risk Category II buildings is greater than 115 mph, and (2) Hawaii, Puerto Rico, Guam, Virgin Islands, and American Samoa."

many residents in the area affected by the May 22, 2011, Joplin tornado, particularly those who were living in multi-family residential buildings or older nursing homes, did not have access to such sheltering options during this tornado.

E.4.2 Findings of the Technical Investigation

NIST's findings are grouped by objective as listed below. To aid in identifying individual findings, the findings are numbered consecutively. In addition, several of the findings in the May 22, 2011, Joplin tornado that pertain to building performance (specifically findings 8, 9, 10, and 17 of Objective 2) listed below are consistent with findings regarding responses of critical and educational facilities during the May 20, 2013, tornado in Moore, Oklahoma (NIST SP 1164, 2013).

Objective 1. Determine the tornado hazard characteristics and associated wind fields in the context of historical data

- ***Measurements of the Near-Surface Wind Field in Tornadoes (< 20 m)***

Finding 1: Current operational weather radar technology is incapable of determining tornado occurrence and intensity at heights above the ground that are relevant to structural engineering design (i.e. at the heights of buildings). For example, because the nearest operational radars to Joplin were more than 60 miles away they could only measure conditions at altitudes starting at 5000 ft.

Finding 2: Reliable direct measurement of wind speed in tornadoes, especially the most intense tornadoes, is lacking or non-existent. Wind speed measurements related, but not directly, to the May 22, 2011, Joplin tornado were limited to one location well outside the tornado damage path. The difficulty in measuring tornado intensity discussed in both Findings 1 and 2 have been noted in previous tornado research.

Finding 3: NIST estimated the maximum wind speeds in the May 22, 2011, Joplin tornado to be 175 mph with up to 25 percent uncertainty. With uncertainty, the upper bound of the estimated maximum wind speed in the Joplin tornado was 210 mph. The uncertainty was due to the use of indirect wind speed estimation methods (i.e., tree-fall analysis, EF Scale). Due to the lack of radar and direct wind speed measurements, indirect methods served as the sole estimators of wind speeds in the May 22, 2011, Joplin tornado. While existing indirect methods cannot be used to unambiguously determine wind speeds that can be used in structural design, the remaining findings in this study are not sensitive to the level of uncertainty in this methodology.

Finding 4: The estimated duration and spatial extent of damaging winds in the May 22, 2011, Joplin tornado were significantly greater than those expected based on those used in current tornado hazard models. This finding is consistent with other studies that have estimated wind fields in actual tornadoes. For example, wind speeds in the Joplin tornado that exceeded those associated with EF-3 accounted for approximately twice the spatial area expected based on modeled estimations for an EF-5 tornado.

- **Assessment of Tornado Climatology, Hazard, and Risk for Structural Design**

Finding 5: The probability of occurrence and subsequent risk of tornadoes is significantly underestimated by point-based methodology. It was shown that actual damage in Joplin and other communities affected by damaging tornadoes was greater than predicted using point-based methodology.

Finding 6: Tornadoes rated EF-3 or lower have accounted for approximately 96 percent of all U.S. tornadoes between 1950 and 2011, over one-third (36 percent) of the approximately 5,600 tornado-related fatalities over the same period, and about 80 percent of the \$25 billion in estimated property losses incurred due to tornadoes between 1996 and 2011. Even in a tornado with intensity greater than EF-3, the wind speeds in the majority of the affected area are equivalent to or less than the maximum wind speeds associated with EF-3 tornadoes. In the case of the Joplin tornado, approximately 40 percent of the fatalities and as much as 90 percent of the tornado area were associated with EF-3 or lower wind speeds.

- **Limitations of the Enhanced Fujita (EF) Scale**

Finding 7: The Enhanced Fujita scale lacks adequate damage indicators (DI's) and corresponding degrees of damage (DOD's) for distinguishing among the most intense tornado events. The lack of DI's and DOD's and overall nature of the EF-scale requires subjective, non-quantitative assessment of tornado damage.

Objective 2. Determine the response of residential, commercial, and critical buildings, including the performance of designated safe areas

- **Building Performance**

Finding 8: Buildings are not designed to withstand tornado hazards and there are no building code requirements for tornado-resistant design. Most buildings in the area damaged by the May 22, 2011, Joplin tornado were subjected to wind speeds close to or above the speeds that would be expected to cause collapse of or major damage to structures designed to the non-tornadic wind design requirements of the building codes applicable to them. Wind-borne debris, which contributed significantly to building damage in Joplin, also is not considered as a hazard in building design.

Finding 9: Regardless of construction type, neither affected residential nor non-residential buildings were able to provide life-safety protection in the May 22, 2011, Joplin tornado. Of the 161 fatalities, 135 (or 83.8 percent) were related to building failure. Of these building failure-related fatalities, 74 (52.5 percent) occurred in residential buildings. Of the buildings that were damaged, 7,411 were residential and 553 were non-residential. All 553 of the non-residential buildings and 3,069 (about 43 percent) of the residential structures sustained either *heavy/totaled* or *demolished* damage classification, resulting in approximately \$1.228 billion in insured losses for non-residential property and \$0.552 billion for residential property.

Finding 10: Among the engineered buildings surveyed by NIST, those with redundant lateral load capacity and those that did not depend on bracing from the roof system for lateral

stability (such as certain steel and concrete moment frame buildings) withstood the tornado without structural collapse. Those with reinforced concrete roofs or composite concrete and steel roofs also withstood the tornado without structural collapse. Those that relied on bracing from a less robust roof system for lateral stability (such as box-type system (BTS) buildings with light steel roof decks) were prone to structural collapse.

- Finding 11:** The structural collapses of NIST-surveyed BTS buildings began with failure of the roof system due to wind uplift (failure of roof-deck-to-joist or joist-to-wall connections), which led to the loss of lateral bracing for perimeter walls, causing them to collapse by rotation at the base due to lateral load. Available design information showed that the roof connections of these buildings were adequate for code-level design wind pressures, making it unlikely that these buildings could have failed in wind speeds under 115–120 mph, which are the “ultimate” (that is, sufficient for failure) speeds corresponding to the code-level winds.
- Finding 12:** BTS buildings, surveyed by NIST, that sustained total structural collapse had two common design features that increased their vulnerability to collapse in the May 22, 2011, Joplin tornado: light-gauge metal roof systems, and friction-only wall-to-footing connections (currently accepted practice for areas with low or no seismic risk).
- Finding 13:** Pre-engineered metal buildings (PEMB) surveyed by NIST sustained significant damage to their envelopes, but no structural collapses of the primary rigid steel frame.
- Finding 14:** Failures of residential wood-frame buildings predominantly involved failure of the connections between structural components, rather than of the components themselves (roof, walls, and floor), with the majority involving disconnection of the roof from walls and walls from foundation. This indicates lack of robustness in the connections and in the continuity of the vertical load path from roof to foundation.
- Finding 15:** Better structural performance in one of the NIST-surveyed multi-family residential buildings in Joplin can be attributed to use of robust hurricane connectors, typically only required for residential wood-frame buildings in hurricane-prone regions.
- Finding 16:** All NIST-surveyed engineered buildings that did not collapse (steel, concrete frame, and PEMB), as well as engineered buildings that collapsed (BTS buildings), sustained significant damage to the building envelopes and interiors due to the combination of wind pressure, impacts by wind-borne debris, and subsequent water intrusion.
- Finding 17:** The failure of building envelopes at St. John’s Regional Medical Center (SJRM), which led to loss of protection and subsequent extensive damage to building interiors (affecting electrical distribution and fixtures, water and gas pipes, HVAC systems and ductwork, and the elevator system and elevator shaft enclosure), was the primary cause for the complete loss of functionality of this critical facility, which occurred despite the robust structural system that withstood the tornado without structural collapse.
- Finding 18:** The majority of the impact-resistant windows on the fifth floor (Behavioral Health Unit) of the West Tower of SJRM remained intact, whereas most regular dual-pane insulated windows at SJRM were broken when exposed to the same tornado hazards.

Finding 19: While there was no direct evidence that roof aggregate contributed to any injuries or fatalities in Joplin, there was evidence that roof aggregates contributed to envelope damage in SJRMC buildings and surrounding structures, thus adding to the tornado debris hazard and the potential for injuries or fatalities.

- ***Performance of Shelters/Safe Rooms/Designated Refuge Areas***

Finding 20: NIST found that Joplin residents had limited access to underground or tornado-resistant shelters. There were no community shelters or safe rooms in the City of Joplin or Jasper County at the time of the May 22, 2011, Joplin tornado. Also, 82 percent of the homes in Joplin lacked basements. Only a few non-residential buildings were equipped with underground locations (e.g., basements), and none was identified as having a tornado-resistant shelter above ground.

Finding 21: While many non-residential facilities had designated refuge areas, several of these areas suffered severe damage and NIST found no evidence that these areas yielded positive outcomes with respect to loss of life. Most high-occupancy commercial and critical facilities surveyed by NIST in the tornado-affected area (SJRMC, schools, and big-box stores) had in-facility designated refuge areas for tornadoes. However, the locations of these areas were not always based solely on structural considerations. There are currently no design standards, requirements, or best-practice guidelines for designating refuge areas within existing commercial or critical buildings.

Finding 22: Currently there are optional model code provisions for the design of specially purposed shelters, but such shelters are not required.

Finding 23: Based on a few instances observed in this tornado, in-home shelters did perform well and provided life-safety protection to the home owners. NIST found no statistics on how many of the 7,411 damaged residential structures had in-home tornado shelters.

Objective 3. Determine the performance of lifelines as it relates to the continuity of operations of residential, commercial, and critical buildings

Finding 24: All utilities (water, gas, power) were lost in the areas damaged by the May 22, 2011, Joplin tornado. The utility providers restored service to critical buildings (SJRMC, water treatment plant) within 24 hours.

Finding 25: The failure of building envelopes at NIST-surveyed critical facilities, and resultant severe damage to their interior and internal lifeline distribution systems, was the primary cause of the facilities' complete loss of functionality despite restoration of utility services within 24 hours.

Finding 26: In critical facilities constructed in Joplin prior to 1998, the design wind speed for high-occupancy buildings was higher than that specified for buildings housing the facilities' backup power generators.

Objective 4. Determine the pattern, location, and cause of fatalities and injuries, and associated emergency communications and public response

Finding 27: During the period from 1950 (i.e., the beginning of official tornado record keeping) through 2011, tornadoes caused approximately 5,600 fatalities in the United States. Within an 80-mile radius around Joplin, 233 deaths (including those caused by the Joplin tornado) were caused by tornadoes during the same period.

Finding 28: The Missouri State Police attributed 161 deaths and the City of Joplin attributed more than 1,000 injuries to the Joplin tornado, which affected an area with an estimated population of 20,820.

Finding 29: Of the 161 deaths resulting from this tornado, 155 (96 percent) were caused by impact-related factors (i.e., multiple blunt force trauma to the body). The others were caused by stress-induced heart attacks, pneumonia, or lightning.

- ***Emergency Communication Prior to May 22, 2011***

Finding 30: There was evidence of high false-alarm rates among the storm-based tornado warnings officially issued for Joplin. From 2005 through 2011, 78 percent (14 out of 18) of the official tornado warnings issued for Joplin did not result in a tornado; this percentage was in line with the 2007–2011 national average storm-based tornado false-alarm rate of 74.7 percent. More recently, over the 5-year period from 2007 through 2011, the Joplin area false-alarm rate increased to 92 percent.

Finding 31: Despite public perception, no evidence was found of high false-alarm rates for Joplin's outdoor siren system. Since 2007, the average rate of activation of the 25-siren outdoor warning system in Joplin was once per year (at most), not including the test activations (1 minute in duration) that occurred weekly.

Finding 32: Joplin residents interviewed after the Joplin tornado believed that there had been a high number of false alarms in Joplin from official tornado warnings and the City's outdoor siren system prior to 2011, even though the siren activation rate was once per year (on average).

- ***Tornado History Prior to May 22, 2011***

Finding 33: Prior to 2011, the roughly 30-square-mile City of Joplin had experienced one tornado rated EF-2 or greater since 1950; this tornado occurred on May 5, 1971. However, also since 1950, 182 tornadoes rated EF-2 or higher had struck within an 80-mile radius of the City.

Finding 34: Prior to the May 22, 2011, Joplin tornado, scientifically unfounded beliefs about tornado movements and the effects of regional topography contributed to a common public perception that the City of Joplin was immune to a direct tornado strike.

- ***Emergency Communication on May 22, 2011***

Finding 35: Two official tornado warnings were issued on May 22, 2011. After the first official warning, Joplin's sirens were sounded but no tornado occurred. After the second

official warning, the siren system was sounded again, 4 minutes after the tornado touched down and almost exactly when the tornado entered the City of Joplin. Both siren soundings took the form of a continuous tone of 3 minutes duration.

- Finding 36:** The function of an alert is to grab people’s attention before/during a disaster; while the function of a warning is to provide information about the event and how the public should respond. Both are necessary in an emergency. Joplin’s outdoor siren system, which could generally be heard indoors as well as outside, was the primary means by which individuals were alerted to a tornado event on May 22, 2011. Radio, television, and word of mouth were the primary means by which individuals were provided with warning information on May 22, 2011.
- Finding 37:** The Joplin–Jasper County Reverse–9–1–1 telephone system was not used on May 22, 2011, due to its inability to disseminate information in a timely manner. It had taken up to 3 hours to get emergency calls out during previous uses, so it is unlikely that the system would have worked in this tornado event.
- Finding 38:** Functioning as an alerting system, only, the outdoor sirens prompted many Joplin residents and visitors to seek further information on May 22, 2011. The multiplicity of information sources, and the conflicting information provided by those sources, added to the public’s confusion about the true hazard as additional information was sought.
- Finding 39:** Across the country, there is no standard method for sounding outdoor public siren systems, which has led to variations in siren usage, activation procedures, and sounding patterns among U.S. communities. Also, there are no nationally accepted standard protocols for the issuance of an all–clear alert following a warning.

- ***Public Response and Consequences on May 22, 2011***

- Finding 40:** Of the 155 impact–related fatalities, 135 (87 percent) involved persons who are known to have been located inside structures during the tornado. The structures in which these people died included both residential (59 percent of the 135 victims) and non–residential (41 percent) buildings.
- Finding 41:** Virtually all of the buildings in which the 135 impact–related fatalities occurred experienced maximum estimated winds associated with tornadoes rated EF–3 or higher. The exceptions were the Meadows Healthcare facility, where two of the deaths occurred, and five single–family homes that were the sites of six of the fatalities.
- Finding 42:** The hospital towers at SJRMC did not provide life–safety protection for all occupants, even though the towers did not collapse. Twelve impact–related fatalities occurred in the hospital, four of which involved patients in intensive care units.
- Finding 43:** Responses to the approaching tornado among members of the public, in many cases, were delayed or incomplete, as was evidenced by the fatalities that occurred among individuals located outdoors, in vehicles, or en route within buildings to safer refuges when the tornado hit.

- Finding 44:** Two factors were found to have contributed to the delayed or incomplete public response to the Joplin tornado. The first was a lack of awareness of the tornado. The second was an inability to perceive personal risk due to one or more of the following: receipt of conflicting or uncertain information about the tornado; pre-existing beliefs about Joplin's immunity to direct tornado strikes; and distrust of or confusion about Joplin's emergency communications system.
- Finding 45:** The main factor that convinced individuals to take shelter was the receipt of high-intensity cues, including hearing or seeing the tornado approaching or witnessing others' urgency related to taking protection.
- Finding 46:** No fatalities occurred in demolished, detached homes in which people took refuge in basements. Additionally, NIST found no evidence that any of those killed were located underground during the tornado.
- Finding 47:** A disproportionate number of people aged 60 years or older died or were injured as a result of this tornado. NIST analysis of the fatalities resulting from the Joplin tornado shows that approximately 8 fatalities occurred per thousand people in Joplin aged 60 years and over compared with 2 fatalities per thousand people in Joplin under 60 years. This disproportionate result remains even after removing all hospital and nursing home deaths. Factors that may have contributed to this outcome include a lack of information flow to these individuals, a lack of supportive social networks among individuals, or inability of an individual to withstand or recover from tornado-induced trauma.

E.5 RECOMMENDATIONS

As part of its technical investigation of the Joplin tornado, NIST has developed 16 recommendations for improving how buildings and shelters are designed, constructed, and maintained in tornado-prone regions, and for improving the emergency communications that warn of imminent threats from tornadoes. These recommendations are listed in Table E-1, below, in three groups that reflect the objectives and findings of the investigation.

Group 1 contains recommendations relating to the characteristics of tornado hazards and their associated wind fields. The recommendations in Group 2 concern the performance of buildings, lifelines, and shelters and designated safe areas. Group 3 recommendations relate to findings about the pattern, locations, and causes of tornado fatalities and injuries, the performance of emergency communications systems, and the public response to this tornado.

The recommendations call for action by specific entities with regard to the development, adoption, and enforcement of standards, codes, and regulations; professional and construction practices, education, and training; and research and development. NIST believes that these recommendations are realistic and appropriate, and are achievable within a reasonable period of time.

NIST strongly urges State and local authorities having jurisdiction to adopt and enforce model building codes and standards. Enforcement is critical to ensuring expected levels of safety. Following good building practices also is critical to achieving better performance of structures during extreme events like tornadoes.

Table E–1. Summary of NIST recommendations.

Recommendation	Interested Parties	Organization with Lead Responsibility for Implementation
Group 1: Tornado Hazard Characteristics and Associated Wind Field		
<p>Recommendation 1: NIST recommends that a capacity be developed and deployed that can measure and characterize actual near–surface tornadic wind fields for use in the engineering design of buildings and infrastructure. This would require enhancement and widespread deployment of advanced technologies, including weather radar.</p>	<p>Academia, Industry, NOAA/NWS, NRC,NSF,DOE</p>	<p>NOAA</p>
<p>Recommendation 2: NIST recommends that information gathered and generated from tornado events (such as the Joplin tornado) should be stored in publicly available and easily accessible databases to aid in the improvement of tornado hazard characterization.</p>	<p>Academia, FEMA, Industry, NGA, NOAA/NWS</p>	<p>NOAA</p>
<p>Recommendation 3: NIST recommends that tornado hazard maps for use in the engineering design of buildings and infrastructure be developed considering spatially based estimates of the tornado hazard instead of point–based estimates.</p>	<p>ASCE, DOE, FEMA, ICC, NRC</p>	<p>NIST</p>
<p>Recommendation 4: NIST recommends that new damage indicators (DIs) be developed for the Enhanced Fujita tornado intensity scale to better distinguish between the most intense tornado events. Methodologies used in the development of new DIs and associated degrees of damage (DODs) should be, to the extent possible, scientific in nature and quantifiable. As new information becomes available, a committee comprised of public and private entities should be formed with the ability to propose, accept, and implement changes to the EF Scale. The improved EF Scale should be adopted by NWS.</p>	<p>Academia, FEMA, Industry, NOAA, NSF, Office of Science and Technology Policy</p>	<p>NOAA/NWS</p>

Recommendation	Interested Parties	Organization with Lead Responsibility for Implementation																																		
Group 2: Performance of Buildings, Shelters, Designated Safe Areas, and Lifelines																																				
<p>Recommendation 5: NIST recommends that nationally accepted performance-based standards for tornado-resistant design for buildings and infrastructure be developed in model codes and adopted in local regulations to ensure the resiliency of communities to tornado hazards. The standards should encompass tornado hazard characterization, performance objectives, and evaluation tools. The standards shall require that critical buildings and infrastructure such as hospitals and emergency operations centers are designed so as to remain operational in the event of a tornado.</p> <p>An example of a tornado performance objectives matrix for buildings of different risk categories is shown below:</p> <table border="1" data-bbox="321 820 1176 1161"> <thead> <tr> <th rowspan="2">Tornado Intensities</th> <th colspan="4">Performance Objectives</th> </tr> <tr> <th>Operational</th> <th>Repairable Occupancy</th> <th>Life Safe</th> <th>Collapse Prevention</th> </tr> </thead> <tbody> <tr> <td>EF1 (86-110 mph)</td> <td></td> <td></td> <td></td> <td></td> </tr> <tr> <td>EF2 (111-135 mph)</td> <td></td> <td></td> <td></td> <td></td> </tr> <tr> <td>EF3 (136-165 mph)</td> <td></td> <td></td> <td></td> <td></td> </tr> <tr> <td>EF4 (166-200 mph)</td> <td></td> <td></td> <td></td> <td></td> </tr> <tr> <td>EF5 (> 200 mph)</td> <td></td> <td></td> <td></td> <td></td> </tr> </tbody> </table> <p>(1) Hardened area, shelter-in-place. (2) Public shelter. * Risk Categories based on ASCE 7-10.</p>	Tornado Intensities	Performance Objectives				Operational	Repairable Occupancy	Life Safe	Collapse Prevention	EF1 (86-110 mph)					EF2 (111-135 mph)					EF3 (136-165 mph)					EF4 (166-200 mph)					EF5 (> 200 mph)					<p>Academia, ASCE, Design and construction industry (ACI, AISC, AWS, PCA, SDI, SJI, TMS), FEMA, ICC, NIST</p>	<p>ASCE</p>
Tornado Intensities		Performance Objectives																																		
	Operational	Repairable Occupancy	Life Safe	Collapse Prevention																																
EF1 (86-110 mph)																																				
EF2 (111-135 mph)																																				
EF3 (136-165 mph)																																				
EF4 (166-200 mph)																																				
EF5 (> 200 mph)																																				

Recommendation	Interested Parties	Organization with Lead Responsibility for Implementation
<p>Recommendation 6: NIST recommends the development of risk-consistent, performance-based tornado design methodologies to ensure that all building components and systems meet the same performance objectives when subjected to tornado hazards.</p>	<p>Academia, ASCE, Design and construction industry (ACI, AISC, AWS, PCA, SDI, SJI, TMS), ICC.</p>	<p>NIST, FEMA</p>
<p>Recommendation 7: NIST recommends that (a) model building codes for new buildings require that tornado shelters be designed in accordance with the ICC 500 standard, (b) model building codes develop and adopt a tornado shelter standard specific for existing buildings, and (c) tornado shelters be installed in new and existing multi-family residential buildings, mercantile buildings, schools and buildings with assembly occupancies located in tornado hazard areas identified in the performance-based standards required by Recommendation 5.</p>	<p>Academia, FEMA, ICC, States and AHJs in tornado-prone areas</p>	<p>ICC</p>
<p>Recommendation 8: NIST recommends the development and implementation of uniform national guidelines that enable communities to create the safest and most effective public sheltering strategies. The guidelines should address planning for, siting, designing, installing, and operating public tornado shelters within the community.</p>	<p>FEMA, ICC, NFPA, NWS, NSF</p>	<p>FEMA</p>
<p>Recommendation 9: NIST recommends that uniform guidelines be developed and implemented nationwide for conducting tornado risk assessments and designating best available tornado refuge areas as an interim measure within buildings until permanent measures fully consistent with Recommendations 5 and 7 are implemented.</p>	<p>Academia, FEMA, DHS S&T, ICC, States and AHJs in tornado-prone areas</p>	<p>FEMA</p>
<p>Recommendation 10: NIST recommends that aggregate, gravel, or stone be prohibited as roof surfacing material or roof ballast for buildings of any height in tornado-prone areas.</p>	<p>ASCE, ICC, States and AHJs</p>	<p>ICC</p>
<p>Recommendation 11: NIST recommends that enclosures for egress systems (elevators, exits) of critical facilities in tornado-prone areas be designed to maintain their functional integrity when subjected to tornado hazards.</p>	<p>Building owners/operators, ICC</p>	<p>ICC</p>

Recommendation	Interested Parties	Organization with Lead Responsibility for Implementation
<p>Recommendation 12: NIST recommends that owners and operators of existing critical facilities in tornado-prone areas perform tornado vulnerability assessments and take steps to ensure the functionality of (1) backup power supplies (harden the protection of emergency backup power, as region-wide losses of power due to damage to power transmission infrastructure occur frequently in tornadoes), (2) vertical movement within the building (elevator equipment and shaft enclosures), and (3) means of egress illumination (battery-powered lighting in addition to backup power), in a tornado event.</p>	<p>DHS S&T, Building owners/operators, States and AHJs</p>	<p>DHS IP/FEMA</p>
<p>Group 3: Pattern, Location, and Cause of Fatalities and Injuries, and Associated Performance of Emergency Communications Systems and Public Response</p>		
<p>Recommendation 13: NIST recommends the development of national codes and standards and uniform guidance for clear, consistent, and accurate emergency communications, encompassing alerts and warnings, to ensure safe, effective, and timely responses among individuals, organizations, and communities in the path of storms having the potential to create tornadoes. NIST also recommends that emergency managers, the NWS, and the media develop a joint plan and take steps to ensure that accurate and consistent emergency alert and warning information is communicated in a timely manner to enhance the situational awareness of community residents, visitors, and emergency responders affected by an event.</p>	<p>Academia, ICC, NEMA, NFPA, NWS, DHS/FEMA</p>	<p>ICC, NFPA</p>
<p>Recommendation 14: NIST recommends that the full range of current and next-generation emergency communication “push” technologies (e.g., GPS-based mobile alerts and warnings, reverse 9–1–1, outdoor siren systems with voice communication, NOAA weather radios) be widely deployed and utilized, to maximize each individual’s opportunity to receive emergency information and respond safely, effectively, and in a timely fashion.</p>	<p>Academia, DHS/FEMA, FCC, NOAA/NWS</p>	<p>NOAA</p>
<p>Recommendation 15: NIST recommends research studies to identify the factors that will significantly enhance public perception of personal risk and how such knowledge can be better used to rapidly and effectively respond during tornadic events.</p>	<p>Academia, DHS, ICC, NFPA, NOAA/NWS</p>	<p>NSF, NIST</p>

Recommendation	Interested Parties	Organization with Lead Responsibility for Implementation
<p>Recommendation 16: NIST recommends that tornado threat information be provided to emergency managers, policy officials, and the media on a spatially resolved real-time basis by frequently updating gridded probabilistic hazard information that is merged with other GIS information to supplement the currently deployed binary warn/no warn system.</p>	<p>NOAA</p>	<p>NOAA</p>

Key: ACI, American Concrete Institute; AHJ, authority having jurisdiction; AISC, American Institute of Steel Construction; ASCE, American Society of Civil Engineers; AWS, American Welding Society; DHS, U.S. Department of Homeland Security; DHS IP, Office of Infrastructure Protection; DHS S&T, Science and Technology Directorate; DOE, U.S. Department of Energy; FCC, Federal Communications Commission; FEMA, Federal Emergency Management Agency; IBC, *International Building Code*; ICC, International Code Council; IRC, *International Residential Code*; NEMA, National Emergency Management Association; NFPA, National Fire Protection Association; NIST, National Institute of Standards and Technology; NOAA, National Oceanic and Atmospheric Administration; NRC, U.S. Nuclear Regulatory Commission; NSF, National Science Foundation; NWS, National Weather Service; OSTP, Office of Science and Technology Policy; PCA, Portland Cement Association; SDI, Steel Deck Institute; SJI, Steel Joist Institute; TMS, The Masonry Society.

E.6 REFERENCES

- ANSI/ANS (American National Standards Institute/American Nuclear Society). 2011. *Estimating Tornado, Hurricane, and Extreme Straight Line Wind Characteristics at Nuclear Facility Sites*. ANSI/ANS-2.3-2011. American Nuclear Society. La Grange Park, IL.
- DOE (U.S. Department of Energy). 2002. *Natural Phenomena Hazards Design and Evaluation Criteria for Department of Energy Facilities*. DOE-STD-1020-2002. Washington, DC, January.
- FEMA (Federal Emergency Management Agency). 2008a. *Taking Shelter from the Storm: Building a Safe Room for Your Home or Small Business*. FEMA P-320, Third Edition. Washington, DC, August.
- FEMA (Federal Emergency Management Agency). 2008b. *Design and Construction Guidance for Community Safe Rooms*. FEMA P-361, Second Edition. Washington, DC, August.
- ICC/NSSA (International Code Council/National Storm Shelter Association). 2008. *ICC/NSSA Standard for the Design and Construction of Storm Shelters*. ICC 500-2008, American National Standard. Washington, DC, June.
- NIST (National Institute of Standards and Technology), 2013. *Preliminary Reconnaissance of the May 20, 2013, Newcastle-Moore Tornado in Oklahoma*. NIST Special Publication 1164. Gaithersburg, MD, November.
- NRC (U.S. Nuclear Regulatory Commission). 2007. *Design Basis Tornado and Tornado Missiles for Nuclear Power Plants*. NRC Regulatory Guide (NRC/RG) 1.76. Washington, DC.

Chapter 1

INTRODUCTION

1.1 THE CITY OF JOPLIN

The City of Joplin, which bore the brunt of the powerful tornado that struck Missouri on May 22, 2011, is located in southwest Missouri, as shown in Fig. 1–1. Joplin is considered the center of what is regionally known as the “four–State area,” because it is the most centrally located city in the area where the States of Arkansas, Kansas, Missouri, and Oklahoma touch. Incorporated in 1873, the city is Missouri’s fourth largest metropolitan area¹⁶, with a population of 50,150.¹⁷ Joplin spans both Jasper and Newton Counties, covering a total of 31.54 square miles. The dividing line between the two counties runs along 32nd Street (see Fig. 1–2), with Jasper County to the north and Newton County to the south.

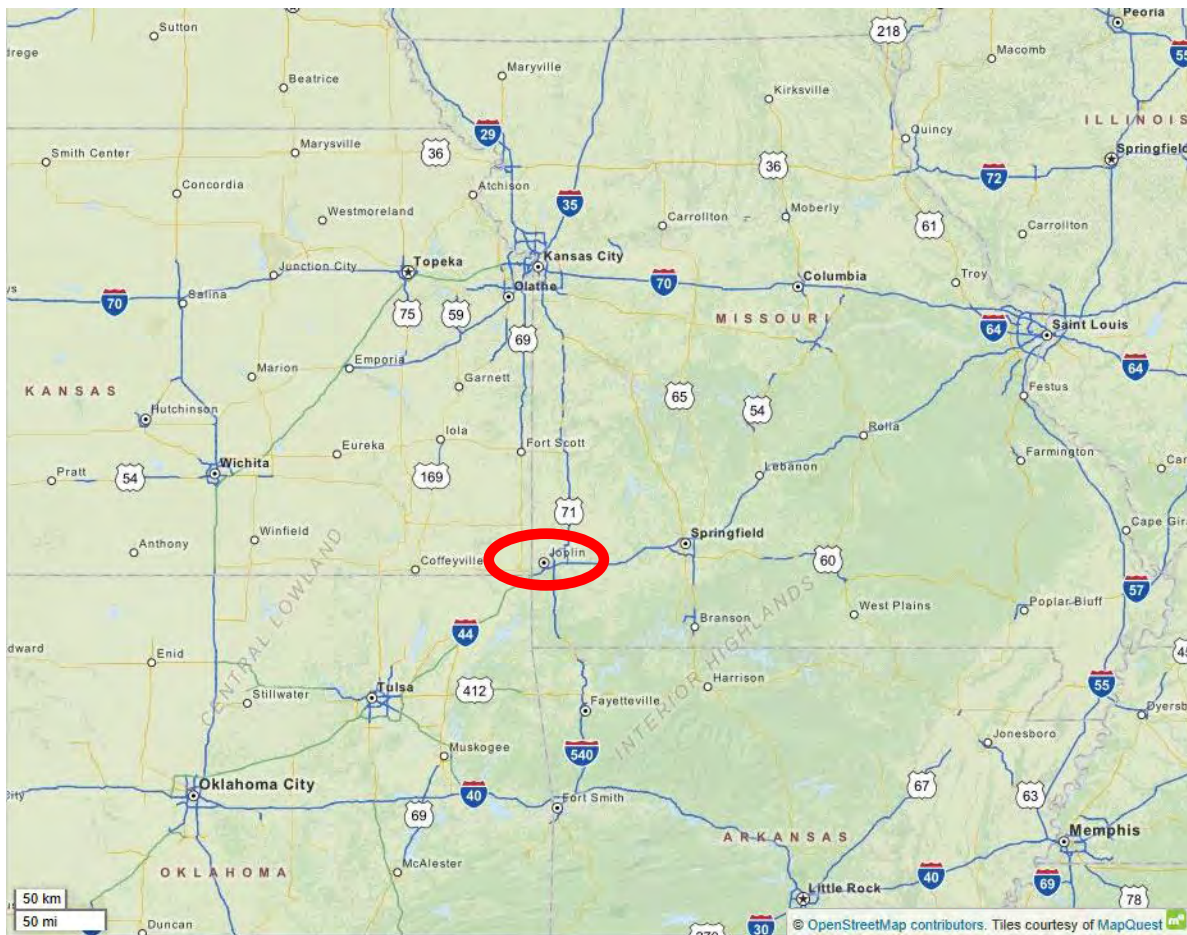

Figure 1–1. Location of Joplin (circled in red) in southwestern Missouri.

¹⁶ Joplin Area Chamber of Commerce (<http://www.joplincc.com/whywedoit.html>).

¹⁷ United States Census Bureau 2010 estimate (<http://quickfacts.census.gov/qfd/states/29/2937592.html>).

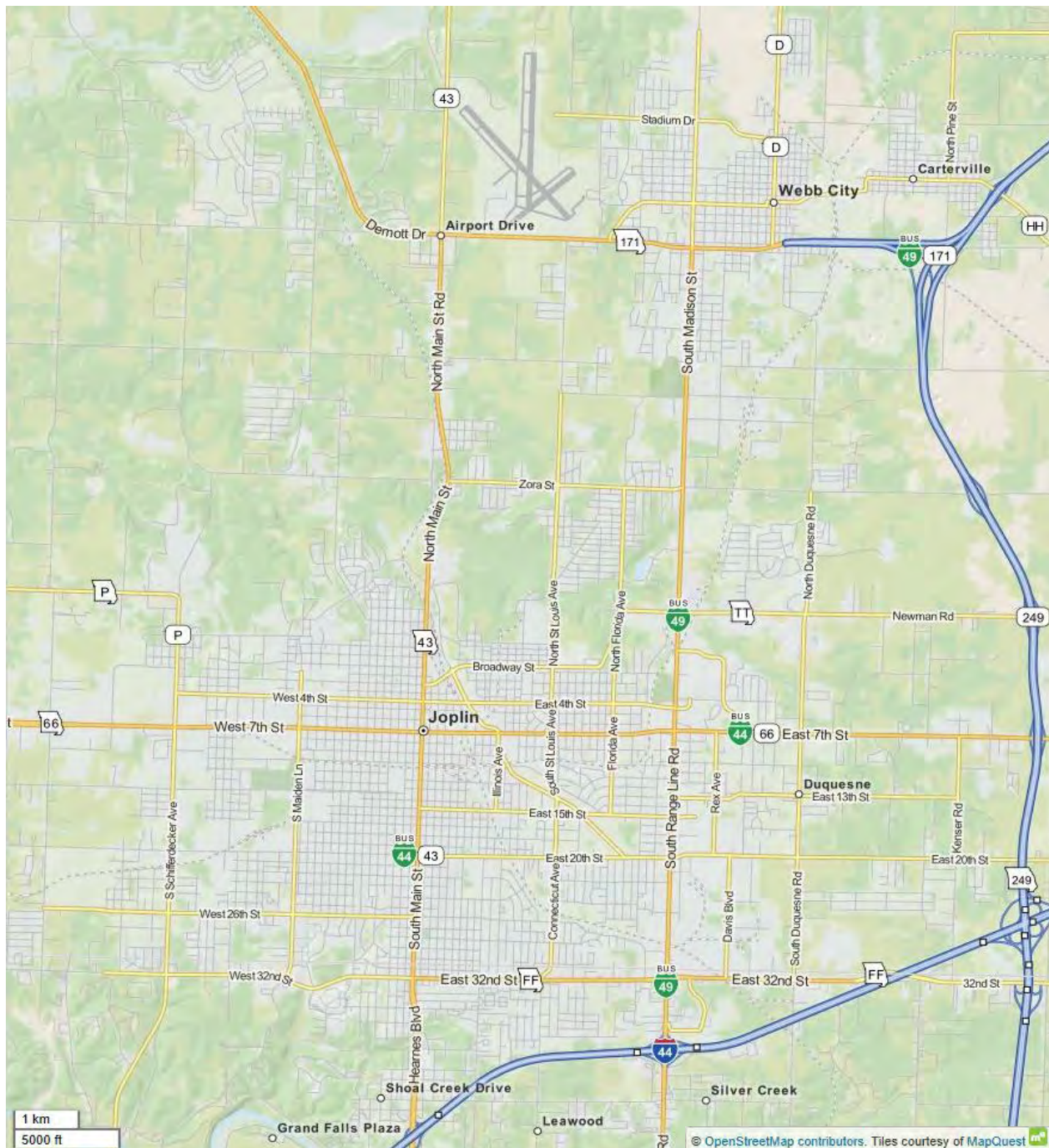

Figure 1–2. Map of Joplin and surrounding area.

Since 1954, the City has operated under the council–manager form of government. There is a governing city council that is responsible for passing ordinances, adopting a budget, appointing committees, and hiring higher–level city officials. The City manager is responsible for carrying out the policies and ordinances of the council, overseeing day–to–day operations of the City, and appointing heads of City

departments. Some planning and management functions are operated jointly between the City and Jasper County, including the Joplin/Jasper County Emergency Management Agency.

Joplin is a commercial, medical, and cultural hub for the four-State region.¹⁸ There are two hospitals located within the city limits, Freeman Health Systems and St. John's Regional Medical Center (SJPMC), which provide health care and employment for thousands of local residents, as well as facilities specializing in sports medicine, psychological and psychiatric services, and heart and cancer care. Three other hospitals are located near Joplin: McCune-Brooks Hospital in Carthage, Missouri (14 miles away); Freeman Neosho Hospital in Neosho, Missouri (15 miles away); and Via Christi Hospital Pittsburg Inc. in Pittsburg, Kansas (26 miles away). Nursing and retirement centers and extended care facilities are also a part of the Joplin area.

Joplin is home to three airports: Joplin Regional Airport (shown at the far north of Fig. 1-2); Five Mile Airport; and a heliport at SJPMC. There are six post-secondary educational institutions located throughout the City. The largest is Missouri Southern State University (MSSU), a State school with more than 4,000 students. Others include Vatterott College, Ozark Christian College, Franklin Technology-MSSU, Messenger College, and New Dimensions School of Hair Design. Joplin has one public high school, Joplin High School, and three private high schools. Like any densely populated city, Joplin has its share of restaurants, shops, hotels, sports and entertainment venues, conference facilities, and other commercial properties.

Due to its centralized location, Joplin makes an attractive home for a number of industries, including manufacturing, retail trade, construction, and transportation.¹⁹ Area employers provide jobs in food processing, metal fabrication, equipment manufacturing, plastics and packaging technologies, customer service, and retail sales. Goods distribution centers, administrative offices, machinery repair facilities, and custom computer-programming services are fueling economic growth in the region. As the regional economic hub, Joplin's population increases by five times during each workday, making for a daytime population of 250,000 people.²⁰

Summary demographic information from the United States Census Bureau indicates that the median age among Joplin residents is 35 years, and that 14.8 percent of residents are aged 65 or older.²¹ The City is essentially split evenly by gender (52 percent of residents are women), and is predominantly (87.6 percent) white. With regard to educational levels, 84.3 percent of Joplin residents aged 25 or older have received at least a high school diploma. The number of households in Joplin totaled 20,552 in 2011, with an average of 2.33 persons per household. More than half (53 percent) of the City's population (over the age of 15) is married, with 23.4 percent never married and the rest separated (2.9 percent), widowed (7.8 percent), or divorced (13.0 percent).²²

Joplin sits within the Ozark Plateau (the Ozarks), which is a heavily forested group of highlands in the south central portion of the United States.²³ Although the plateau extends from St. Louis, Missouri, to the

¹⁸ Joplin Area Chamber of Commerce (<http://www.joplincc.com/joplinhistory.html>).

¹⁹ Ibid.

²⁰ Joplin Area Chamber of Commerce (<http://www.joplincc.com/whywedoit.html>).

²¹ United States Census Bureau (<http://quickfacts.census.gov/qfd/states/29/2937592.html>).

²² Citi-Data.com (www.city-data.com/city/Joplin-Missouri.html#ixzz2Kzi6gTDD).

²³ Arkansas Geological Survey (www.geology.ar.gov/education/ozark_plateaus.htm); Encyclopedia Britannica (<http://www.britannica.com/EBchecked/topic/437144/Ozark-Mountains>).

Arkansas River, it is divided into three different plateau surfaces: the Springfield Plateau; the Salem Plateau; and the Boston Mountains Plateau. Joplin is located within the Springfield Plateau, which is characterized by gently rolling hills (or undulating topology) above ground, and caves and sinkholes, common in limestone below ground. The Ozarks also contain deposits of lead, zinc, iron, and barite ores. Development in Joplin initially began because of lead mining; however, it was the discovery of zinc that spurred the growth of Joplin in the early 20th century. Most of the mines were closed after World War II, leaving mine workings under nearly 75 percent of the city.

Due to the many near-surface mine tunnels²⁴ and other unfavorable soil conditions (high water table and limestone just below the surface²⁵), most of the homes in Joplin (83 percent²⁶) do not have basements. Additionally, very few residences in Joplin have tornado shelters or safe rooms.²⁷ In contrast, public safety guidance from the National Weather Service (NWS)²⁸ indicates that underground shelters, basements or safe rooms are the safest places in a tornado.

Residents in the Joplin area are no strangers to tornadic activity given the area's proximity to tornado alley.²⁹ Statistics gathered by the NOAA/NWS Storm Prediction center (SPC) indicate that between 1950 and 2011, the area within an 80-mile radius of Joplin experienced a total of 766 tornadoes, an average of 12.5 per year. Of these, 24 percent were rated EF-2 or greater on the Enhanced Fujita Scale,³⁰ and 6 percent were rated EF-3 or greater.

There have been very few instances, however, of significant tornadoes striking within the City of Joplin. Prior to May 22, 2011, only one tornado rated EF-2 or greater had struck Joplin since record-keeping began in 1950. On May 5, 1971, a tornado spawned by violent thunderstorms touched down in Joplin at about dusk. This tornado was one of many that struck Oklahoma, Arkansas, Kansas, Nebraska, and Iowa that day, and was one of at least 14 confirmed tornadoes in southwestern Missouri. The tornado damaged a 37-block section of the City, injuring 45 persons, killing 1, and causing an estimated \$7 million in damage (1971 dollars). The 1 fatality occurred when the tornado struck the Anderson Mobile Trailer Court, where 15 trailers were destroyed. Ten residences and at least three other mobile homes were reported to have been destroyed in the storm. Additionally, 60 other homes and 22 businesses were heavily damaged, and another 320 homes sustained minor damage. News accounts at the time indicated that the tornado sirens were not sounded until the tornado had already touched down and was moving through the City. The National Severe Storms Forecast Center issued a tornado warning and notified the Joplin police at 6:15 p.m. CDT. However, the sirens were not sounded until 38 min later at 6:53 p.m., when a Joplin police officer on patrol witnessed debris flying through the air. At the time, the standard operating procedure in most communities was to sound the sirens when the tornado warning was issued, because a "warning indicated that a tornado had been sighted in or near the area of the warning." Damage from the 1971 storm is shown in Fig. 1-3.

²⁴ NIST Interview with City of Joplin Building Official and Code Enforcement Supervisor

²⁵ Reuters (www.reuters.com/article/2011/05/31/us-tornado-basements-idUSTRE74U6HT20110531).

²⁶ Data from Jasper County Assessor's office.

²⁷ NIST Interview with City of Joplin Building Official and Code Enforcement Supervisor

²⁸ NOAA (<http://www.nws.noaa.gov/om/severeweather/resources/ttl6-10.pdf>).

²⁹ "Tornado Alley is a nickname given to an area in the southern plains of the central U.S. that consistently experiences a high frequency of tornadoes each year." NOAA (<http://www.ncdc.noaa.gov/oa/climate/severeweather/tornadoes.html#alley>).

³⁰ The Enhanced Fujita (EF) Scale is used by the NWS to rate the intensity of the maximum wind speeds in a tornado based on observed damage, with EF-0 being the lowest (beginning with winds of 65 mph or more) and EF-5 the highest (winds exceeding 200 mph). See <http://www.spc.noaa.gov/efscale/> and Secs. 2.3.4.1 and 2.5 for more information.



Figure 1–3. Damage from the 1971 Joplin tornado.³¹

The relative lack of tornado strikes within the city was one of the factors that led to a false impression among many Joplin residents that tornadoes would not strike the City. Many believed that tornadoes would not track directly through the City, but instead would track only to the north or south of the City, missing Joplin completely. Some believed that the topography around Joplin had something to do with tornado tracking, protecting the city from direct hits. However, the 1971 tornado demonstrated that Joplin was not immune to tornado strikes.

The prevalence of tornado-related false alarms in Joplin and surrounding areas also fed the notion that tornadoes would not strike the City. Over a period of 7 years (from 2005 to 2011), Joplin experienced a 78 percent false alarm rate, and although similar to the NWS national average (74 percent), nearly 8 out of 10 tornado warnings in Joplin were not followed by tornadoes. Additionally, prior to May 22, 2011, sirens in Joplin were audibly tested on a weekly basis and also sounded on average once per year for non-tornadic high-wind events, potentially resulting in further desensitization among residents.

³¹ From Baron, H. (Ed.). 1971. *The Joplin Tornado*. Boone Publications. Available online at www.joplinpubliclibrary.org/digitized/joplin_tornado_booklet.php.

1.2 THE EVENT

Following is an account of the Joplin tornado and its impacts on the community. Data and information supporting this reconstruction of the events of May 22, 2011 were collected from many sources, including through site visits, interviews with residents and survivors of the tornado, government officials, and others. Details of the collected data and subsequent analyses, along with any associated assumptions and uncertainties, are reported in Chapters 2 through 4.

In the days leading up to the Joplin tornado of May 22, 2011, forecasters at the SPC in Norman, Oklahoma, were becoming more confident that a significant weather event was approaching that would include thunderstorms and possibly tornadoes for a region that included Joplin. On Sunday, May 22, 2011, the SPC issued a tornado watch for Joplin and surrounding communities at 3:00 p.m. Although conditions favoring thunderstorms were present in the region, conditions in Joplin itself were relatively quiescent at this time. Joplin residents and visitors engaged in normal activities throughout the City in the afternoon hours. At home, residents spent time watching television—mostly news or cable programming—eating or preparing dinner, doing chores, getting ready to leave (for work or church, for example), or sleeping. Some were monitoring the weather, checking radar via the Internet or switching back and forth between the Weather Channel and local news or weather reports on television. Outside of homes, individuals were working the afternoon/evening shifts at local restaurants, businesses, and hospitals; completing their Sunday errands (often with the vehicle radio on); visiting friends or family; or attending local worship services or religious classes. Additionally, 6,000 to 7,000 people were attending the high school's graduation ceremony at MSSU in northwest Joplin.

Thunderstorms eventually did form in the region, and at approximately 5:00 p.m., storms to the west of Joplin began to intensify. At 5:09 p.m., a storm developed signs of rotation and the NWS issued a tornado warning. Individuals in and around Joplin who were tuned into television programming or radio broadcasts most likely received word of this warning, as the Emergency Alert System was activated to accompany the tornado warning. Although the tornado warning was disseminated via NOAA Weather Radio broadcasts and media-delivered mobile text-based services, their use by the public was not prevalent in Joplin. Also, the Joplin-Jasper County Reverse-9-1-1 system was not used due to the time required for its operation. Although the 5:09 p.m. tornado warning pertained mostly to areas outside of Joplin, a small portion of northeast Joplin was included in the coverage area. A few minutes later, at 5:11 p.m., the 25-siren alert system was activated throughout Joplin (when one or more sirens are sounded, all 25 must be sounded). The decision to sound the siren system was made by the Joplin-Jasper County emergency manager based on conversations between emergency management personnel in Cherokee County, Kansas (immediately west of Jasper County) and Joplin-Jasper County, information received from the NWS about the impending (5:09 p.m.) warning affecting northeast Joplin, the direction of travel of the storm that was the subject of the 5:09 p.m. warning, and anecdotal information from a local emergency official (outside of Joplin) regarding the destruction associated with that storm. The outdoor sirens sounded a single continuous tone for 3 min. The length and sound patterns of this continuous tone vary from those of other communities in the United States, and there is no standard method for sounding outdoor public warning systems in the United States.

Although Joplin's siren system was intended to alert individuals located outdoors of impending severe weather, many individuals who were indoors also heard the sirens. The sirens could be heard in stores, places of worship, nursing homes, entertainment facilities, and other structures. However, many stores

had managers on duty monitoring the weather even before the sirens sounded. Some larger stores, such as Home Depot, had procedures in place under which managers received custom alerts to provide early notification of weather emergencies. Store managers relayed important sheltering information to patrons, in larger stores via public address systems. Similarly, SJRMC relayed weather information and sheltering instructions, under a procedure known as Condition Gray, when the head nurse verified that sirens were sounding in Joplin. Staff, patients, and visitors were informed that there was severe weather in the area, and that patients were to be moved from their rooms, if possible, into interior hallways. The sirens could also be heard inside residential structures, including multi-family and single-family homes. In addition, some portion of the residents in homes was already monitoring weather information via television or radio.

Regardless of their location, individuals frequently attempted to confirm the weather-related information they received through additional sources. Persons first alerted by the outdoor siren system, for example, often consulted media sources, other people, or their physical environment (i.e., by looking outside for any indication of bad weather) for confirmation that a tornado was actually upon them. Unfortunately, early in the warning process, confirmation was almost impossible. All warning information provided prior to 5:17 p.m. related to a storm that weather forecasters were tracking to the north of Joplin, that was heading toward Webb City or Carl Junction (Missouri communities located north of Joplin). Around this same time, the environment offered very little in the way of cues of an impending storm, also making it difficult to confirm the tornado risk. People looking to the sky saw only clouds that did not look as menacing as those that would normally accompany a tornado. The lack of confirming cues, complicated by the public's perception that tornadoes tended to track around Joplin, caused many Joplin residents to feel that they were not at risk. Some continued to monitor the weather, however, while others did not.

A number of storms continued to develop to the south and west of the storm that was the subject of the 5:09 p.m. tornado warning, and at 5:17 p.m., another possible tornado was indicated on radar. Consequently, another tornado warning (the 18th affecting Joplin since 2005) was issued by the NWS, and this time the coverage area included the entire City of Joplin. Although the radar indicated a possible tornado on the ground, it could not initially detect the potential severity of the tornado because of the limitations of radar coverage in this region.

Around the time of the second NWS tornado warning at 5:17 p.m., Joplin residents who had continued to monitor the weather do not recall receiving confirming evidence of a tornado. First, the outdoor siren system was not activated again for the 5:17 p.m. warning, probably because Joplin's emergency manager had already sounded the system 6 min earlier (for the storm that had threatened northeastern Joplin). Additionally, the media continued to report on storms said to be passing to the north and missing Joplin, or moving away from the City. Others recall announcers continually discussing a tornado between Carl Junction and Webb City, or news of a tornado that had hit a small town in Kansas.

Meanwhile, skies to the west of Joplin darkened further, the base of the clouds lowered, and based on reports from police observing the storm and video evidence on the ground, a tornado (initially with multiple vortices) touched down just to the west of Joplin's city limits at approximately 5:34 p.m. In the vicinity of the initial touchdown and during the ensuing few minutes, trees were uprooted and snapped and sporadic damage occurred to the residences in the few subdivisions in the area (Fig. 1–4). Around this time, wind speeds at Joplin Regional Airport, the location of the lone wind speed measuring device, 5 miles to 6 miles away from the tornado center, began to increase to over 40 mph and would continue to be

this high at this location for the remainder of the time the tornado was in the City of Joplin. The airport's consistent wind speed measurement indicated that the Joplin tornado affected a large spatial area and subjected the area to strong winds over a long period of time.

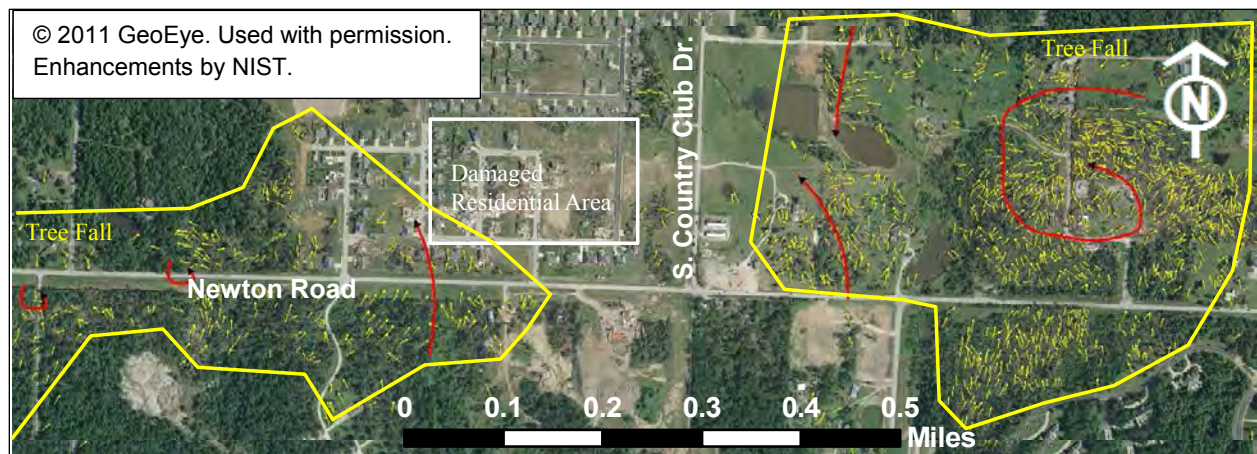

Figure 1–4. Initial damage in the Joplin tornado. Yellow arrows indicate directions of treefall. Possible multiple vortices shown by red arrows.

As the storm and the tornado moved in an eastward direction toward the city limits of Joplin, the tornado began to merge into one large vortex and rapidly increase in size.³² At approximately 5:38 p.m., public awareness of the situation had begun to increase substantially as the tornado had now entered the City of Joplin. The Joplin–Jasper County emergency manager decided to sound Joplin's 25–siren system a second time at 5:38 p.m. Even though Joplin–Jasper County emergency procedures did not specify the use of a second warning, the decision to sound the sirens a second time was based upon discussions between Joplin–Jasper County Emergency Management and the Joplin Fire Department regarding an NWS statement on the size and intensity of the tornado. Also, around this time, television and radio stations were reporting weather information that caused people in Joplin to take notice. The media reported that a tornado had touched down just to the west of Joplin at Iron Gates, Missouri. NBC's KSNF–TV, which was equipped with a tower camera, showed video footage of the imminent tornado strike and pleaded with its listeners to “Take cover now!”

The tornado approached Schifferdecker Avenue, a north–south road on the western edge of the city that bordered the heavily populated areas of Joplin. Wind speeds began to rapidly increase along Schifferdecker Avenue as the tornado grew closer, and trees began to sway, bend, and fall inward towards the tornado. A driver in this area recalled seeing a wall of water that he assumed was simply straight–line winds, until he drove into it. Trees were falling down all around his car and limbs 2 in. to 4 in. in diameter were dragged across the road in front of him. An estimated 10,000 trees fell due to the tornado, an indicator of the size and power of this event. The tornado caused its first significant damage to a subdivision immediately to the west of Schifferdecker Avenue, creating a lot of debris as a result. The tornado also claimed its first fatality around this time in a vehicle on Schifferdecker Avenue.

³² All references to the size of the tornado are based upon the tree–fall analysis discussed in Chapter 2 of this report.

This death on Schifferdecker Avenue would be the first of 161 fatalities resulting from the Joplin tornado³³. Moving in an east–northeasterly direction, the tornado proceeded to damage other highly populated areas on the east side of Schifferdecker (see Fig. 1–5), including a residential neighborhood that comprised ranch–style homes, with basements, built primarily during the early 1980s. Although these homes were damaged significantly, no one was killed in this neighborhood.

One–half mile northwest of that early 1980s neighborhood, a man took refuge in the bathroom of the single–family home he was renting. After tracking the storm online and hearing the second siren, he had decided that protective action was necessary. Within minutes, he could hear the tornado tearing the house apart, and was thrown into the air and landed in his backyard. Located next door was one of the first non–residential structures that the tornado had encountered in Joplin, the St. Paul’s United Methodist Church. The storm completely destroyed the envelope (i.e., exterior walls and roof) of St. Paul’s Mass Hall building, leaving only the pre–engineered structural frame of the building intact.



Figure 1–5. Damage on the west side of Joplin.

The tornado continued to increase in size and changed direction from slightly north of east to due east along 26th Street, continuing to wreak havoc on residential areas in its path. Because there were no community storm shelters in Joplin and only 18 percent of homes had basements, residents in homes without basements reportedly took shelter in internal (or centrally located) bathrooms, closets, laundry rooms, or hallways of their homes. Very few residents had in–home shelters. Those who did and were in the storm’s path survived in these pre–manufactured shelters while their wood–framed homes were destroyed around them.

Upon reaching the eastern end of the residential area, the tornado impacted another non–residential building, the Joplin Elks Lodge. Someone had just entered the building, shouting about the approaching

³³ Earlier fatality estimates made by the NWS following the May 22, 2011, Joplin tornado listed the death toll at 158. This report also counts 3 indirect fatalities for a total of 161.

tornado, and all five individuals inside the building had started to run for the kitchen's walk-in cooler. None made it to the cooler before the tornado completely demolished this wood-framed structure. Four of the five occupants died, of impact-related causes.

A few minutes later, at approximately 5:40 p.m., the tornado approached an area with a number of medical and office buildings (Fig. 1-6). Centered around the intersection of 26th Street and Maiden Lane, this area included several small commercial office buildings, such as the Ramesh Shah Ophthalmology Center, as well as SJRMC and Mercy Village Apartments (an assisted-living complex near the east side of SJRMC). SJRMC was vitally important to the region, providing jobs to more than 1,700 people and care for 140,000 area residents.³⁴ The facility comprised two complexes, each with several buildings that housed different medical services and doctors' offices. Most notable structurally were the West Tower, a seven-story reinforced concrete building constructed in 1965, and the East Tower, a nine-story steel structure built in 1985, both of which contained inpatient rooms. The towers were the tallest buildings in the immediate area. Other structures at SJRMC included the Emergency Generator building, the Chiller Plant building, the Oncology Clinic building, and three medical office buildings.

Located just south of the estimated center of the tornado track, SJRMC likely experienced some of the storm's highest winds as well as significant impacts from windborne debris. Besides demolishing the Emergency Generator building and thus destroying SJRMC's ability to function on backup power, the tornado severely damaged the windows, doors, walls, and roofs of the other buildings at SJRMC, including the two towers. Failure of the building envelopes subsequently allowed strong wind, water, and windborne debris to penetrate the building interiors and damage their contents, walls, ceilings, and building systems (e.g., electrical, mechanical, plumbing, elevators, etc.). The extensive damage rendered this critical facility completely nonfunctional, despite the fact that most of its buildings were able to withstand the strong winds without structural collapse.

Failure of the building envelopes at SJRMC also put the 183 patients and staff who were at the hospital on May 22, 2011, in extreme danger of bodily harm. Many of the patients, visitors, and staff who were in the two towers during the tornado had taken shelter in internal hallways in preparation for the storm. They recalled hearing doors blow open as the tornado hit, which sent everything from one end of the hall flying into the other end. Survivors were hit with medical equipment, hospital furniture, ceiling tiles, broken glass, hailstones, and other windborne debris. Due to the complete loss of power and the amount of damage and debris, the staff quickly realized that the facility could no longer provide proper medical care and thus would have to be evacuated. Decisions to evacuate were subsequently disseminated via word of mouth from floor to floor, since the loss of power also rendered the public address system inoperable.

Tornadoes that strike populated areas leave a number of indicators of their strength in addition to damaged and destroyed buildings. Just outside the two SJRMC towers, concrete parking bumpers in the parking lot were pulled up from the ground, parking signs were flattened, and cars were thrown into the air. In other locations, steel manhole covers and tractor-trailers were tossed around by the storm. However, determining the wind speeds required to do such damage is an inexact science.

³⁴ Lawrence, E. C., Qu, J. Q., and Briskin, E. N. 2011. The Economic Impact of Mercy on the Joplin Area. Available online at <http://www.mercy.net/sites/default/files/files/joplin-economic-impact1-5714.pdf>.



Figure 1-6 . Aerial photo showing damage to SJRMC and the surrounding area.

A total of 14 lives were lost at SJRMC as a result of the tornado. Due to the significant damage sustained by all of the buildings, Mercy, the parent organization of SJRMC, decided to raze the entire facility beginning in January 2012. This represented an insured loss estimated at \$600 million.³⁵

Nearly a third of a mile north of SJRMC, close to the northern fringe of the tornado path, wind speeds were still strong enough to cause damage. These winds did minor damage to a water treatment plant (Fig. 1–6), and collapsed an old unreinforced brick masonry building that was used for storage. The Mercy Village Apartments building, a wood–framed structure located approximately one–fourth mile south of the tornado center and directly east of SJRMC suffered only light damage to its envelope. The strong performance of this three–story wood frame building, which was built in 2003, was likely due to the inclusion of hurricane tie–downs and concrete anchors in its construction. These components created a robust and continuous vertical load path for this building.

This area was also home to the Stained Glass Theater, where Joplin area residents attended live stage plays (see Fig. 1–6). There were 56 people in the theater at the time of the tornado.³⁶ Three of these occupants lost their lives due to injuries sustained as the tornado struck. According to interviewees, the victims did not make it into the basement before the tornado hit. The theater director, who was standing at the top of the basement stairs when the building was hit, was injured and died one week later. The other two victims died in the theater, due to multiple blunt force trauma to the body. Six other occupants were seriously injured; however, it is not known where they were located inside the building when their injuries occurred.

As the tornado left the SJRMC area, it continued to move to the east along 26th Street and took aim at a mixed residential and school area that included the Greenbriar Nursing Home, St. Mary’s Catholic Elementary School, the Ozark Center for Autism, and Empire District Electric (EDE) substation 59 (Fig. 1–7). These structures were all directly north of 26th Street, bounded by Jackson Street on the west and Main Street to the east. A total of six fatalities occurred in single–family residential structures in this area.

The center of the tornado passed directly over the Greenbriar Nursing Home, and the one–story, wood–framed structure was completely demolished, causing 19 fatalities out of a total of 95 occupants. Emergency procedures for tornadoes at the nursing home called for the staff to move residents to inner hallways and close all doors to residents’ rooms (to avoid flying window glass). All of the injuries that led to deaths were due to impact–related causes, except for one individual whose cause of death was pneumonia.

About 300 ft north of the Greenbriar Nursing Home was the Ozark Center for Autism. This facility, a three–story concrete building with a two–story steel–framed addition, sustained heavy damage to its envelope and interior. Despite remaining structurally intact, the facility was rendered unusable by the damage. A little further to the east, the tornado completely demolished the concrete masonry building of St. Mary’s Catholic Elementary School. Neither of these facilities was occupied at the time.

³⁵ The Insurance Insider (www.insuranceinsider.com/-1233557/15).

³⁶ Stained Glass Theatre of Joplin (<http://www.sgtjoplin.org/id61.html>).



Figure 1–7. Aerial photo showing locations of the Ozark Center for Autism, Greenbriar Nursing Home, St. Mary’s Catholic Elementary School, and EDE substation 59 (from west to east). Residential area is outlined in white.

Empire District Electric (EDE) substation 59 was located adjacent to St. Mary’s School and in close proximity to the tornado center line. This steel-framed substation, which delivered electrical power to residences and businesses in the vicinity, including SJRMC, was completely destroyed. It was one of six power substations impacted by the event. The destruction of this substation and the extensive damage to other electrical transmission and distribution systems resulted in a loss of power to more than 20,000 EDE customers located inside and outside of the tornado-damaged area. The tornado also wreaked havoc on water and gas distribution systems. It caused thousands of small leaks in residential and fire water-service lines and a subsequent sharp drop in water pressure in the area. Additionally, there was extensive damage to gas mains and meters, which resulted in numerous gas leaks in the affected area.

The tornado then took a sharp turn northeast and moved directly into the heart of another residential area, bounded by 20th Street on the north, 32nd Street on the south, Main Street on the west, and Indiana Avenue on the east (Fig. 1–8). There were 15 fatalities among the residences in this area, all from impact-related causes.

Just to the northeast of this residential area was a group of school and church buildings, including the Franklin Technology Center (a trade school), Joplin High School (the city’s sole public high school), and Harmony Heights Baptist Church. Surveillance video from Joplin High School shows that as the tornado approached the vicinity of the school, trees and light poles began to collapse near the baseball field, and

Figure 1–8. Aerial photo showing the locations of a heavily damaged residential area, Franklin Technology Center, Joplin High School, and Harmony Heights Baptist Church. The color of each building footprint shows the level of damage to that structure.

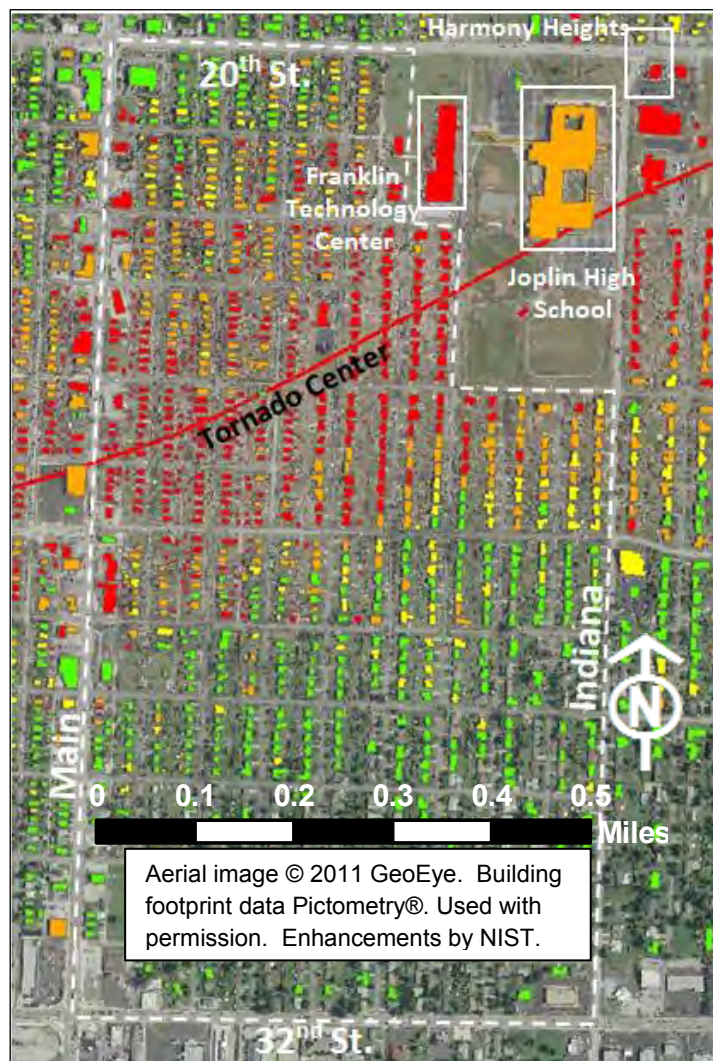

Damage Key:

■ Light ■ Medium ■ Heavy/Totaled ■ Demolished

the air was littered with debris. The tornado reduced Franklin Technology Center to rubble and demolished the auditorium and gymnasium buildings (two structures with long-span roofs) at Joplin High School, while leaving the other high-school buildings substantially damaged but structurally intact.

Although no one was inside Joplin High School or Franklin Technology Center at the time of the storm, individuals at that time were attending services at the nearby Harmony Heights Baptist Church. By the time of the second siren sounding, the attendees had taken shelter, some in the church library and others in the children’s nursery. Those in the library laid down on the floor and waited for the tornado to pass. Three women died when the storm hit, all from impact-related injuries. One woman was crushed to death in the nursery while laying over her son (who survived). Another woman was killed as she stood in the doorway of the nursery. The third was fatally injured as she lay on the floor of the library and was pelted by debris.

The tornado then made another right turn and headed due east as it reached 20th Street, a major artery in Joplin (see Fig. 1–9). At the intersection of 20th and Connecticut, a number of vehicles with occupants

were located in the storm's path. Drivers in this area recalled that rather than witnessing a funnel-shaped tornado, the sky suddenly went black and they could see nothing. As the tornado moved closer, the debris wall grew thicker and drivers were unable to see the road ahead of them. One mentioned that she realized she was in trouble when she saw a car blowing across the street directly in front of her truck. Individuals located in vehicles along 20th Street were reportedly pummeled by debris (through broken windows), and in some cases, had their cars lifted and thrown by the winds. Two individuals died in their vehicles along this stretch of 20th Street, both from impact-related injuries.

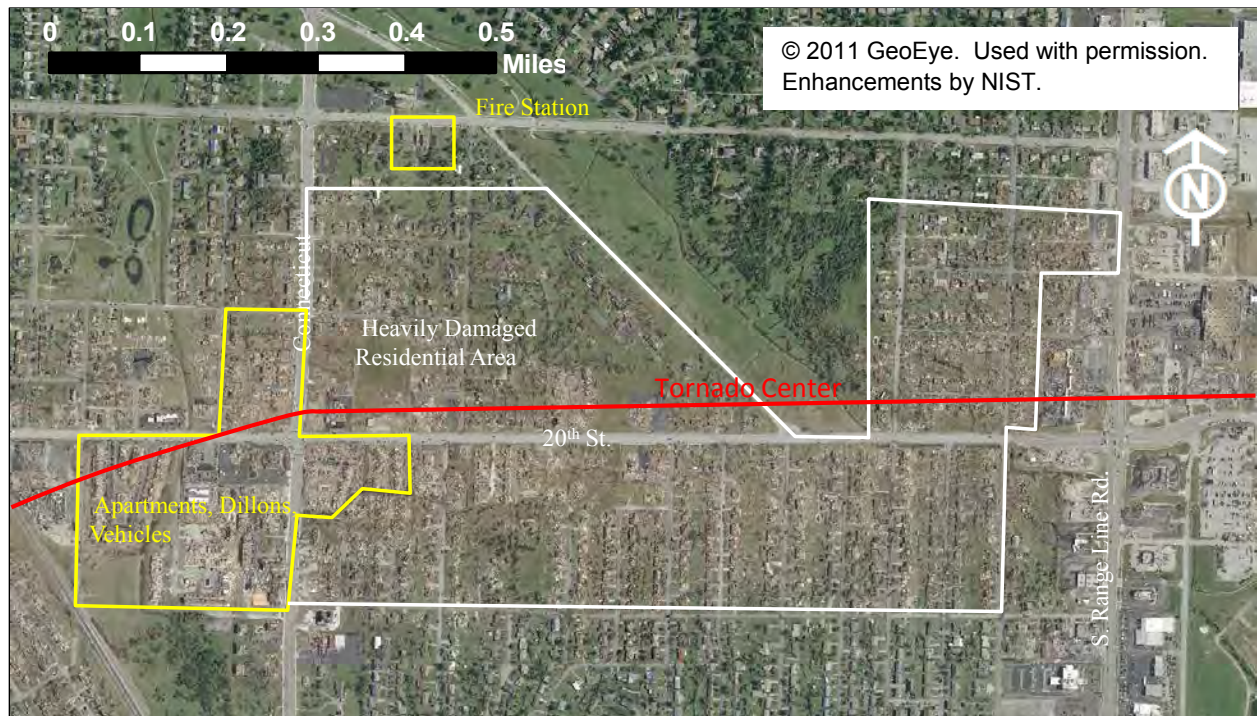

Figure 1–9. Aerial photo of damaged residential areas (including apartment complexes) in Joplin near the intersection of 20th and Connecticut.

A number of apartment complexes were located in this area, including Somerset Apartments, Connecticut Pointe Apartments, and Hampshire Terrace. In the Somerset complex, a survivor recalled evacuating her apartment and taking refuge underneath the building's staircase with her neighbors, rather than remaining inside her garden-style apartment. Her complex, along with Connecticut Pointe and Hampshire Terrace, were significantly damaged in this storm. All 12 of the fatalities that occurred in apartments during the tornado happened in these three complexes, and all were from impact-related causes.

At the southwest corner at 20th and Connecticut was the Dillon's grocery store, where 35 people took refuge inside the store's produce cooler. Even though the building was demolished, everyone inside the store survived with only minor cuts, bruises, or scratches. One of Joplin's fire stations was also in this area, to the north of 20th Street. Although this station was located beyond the range of the most extreme wind speeds, the station's garage door was blown open, its roof was lifted off and disconnected from the structure, and the fire trucks that were housed inside were damaged. The tornado also affected another

residential area to the north and south of 20th Street. Six fatalities occurred in homes within this area, which is outlined in Fig. 1–9.

Continuing eastward, the tornado reached a major intersection at 20th Street and Range Line Road (see Fig. 1–10). The commercial district around this location included small stores, restaurants, and large chain stores. Businesses in the area included AT&T, Pizza Hut, Macadoodles, Walmart, and Home Depot. The center of the tornado passed just to the north of 20th Street between Walmart and Home Depot and very near to the Pizza Hut. An industrial district was located on the east side of this area.

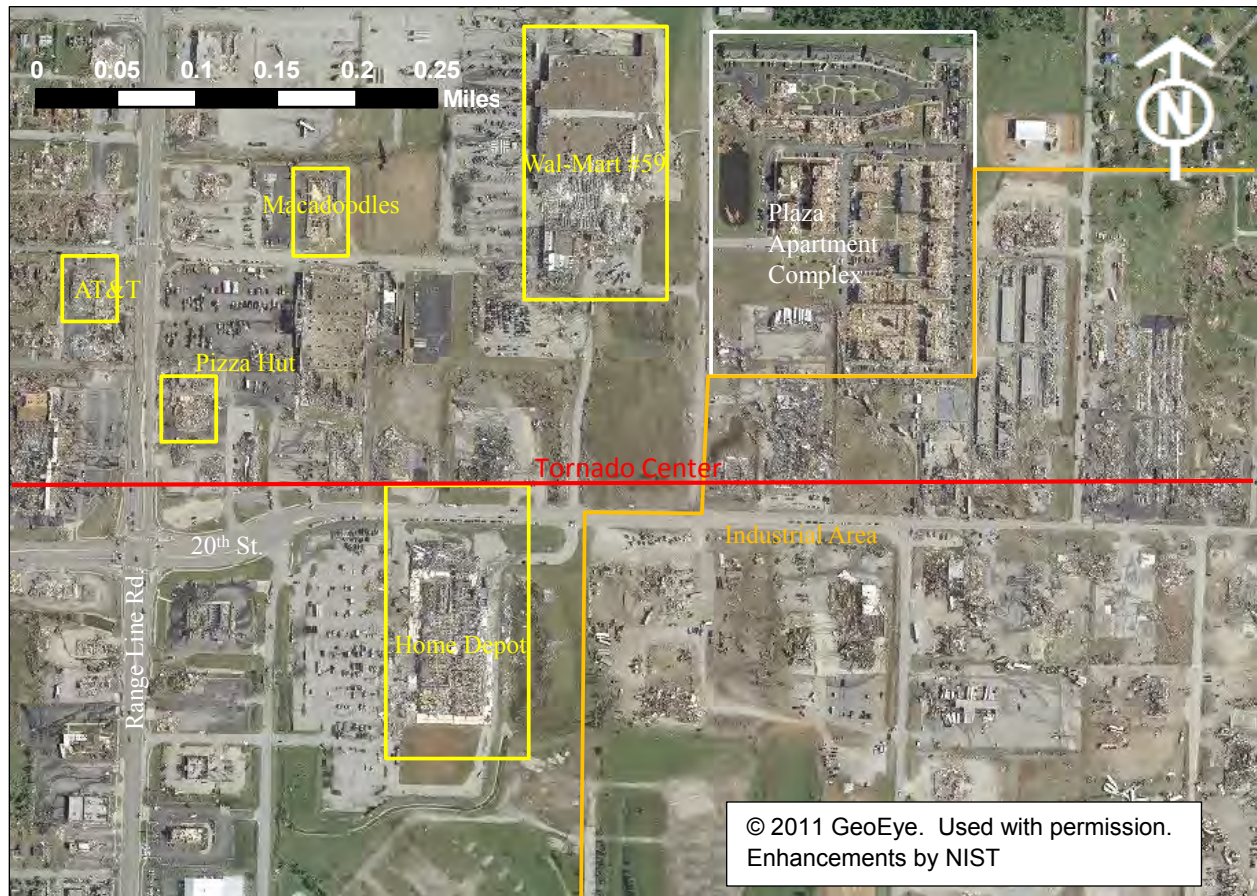

Figure 1–10. Aerial photo showing damage to a commercial area on the eastern side of Joplin near the intersection of Range Line Road and 20th Street.

Media reports stated that 11 people, 5 of whom were employees, were located inside the AT&T store during the storm. All of the occupants sought refuge in the men’s bathroom located at the back of the store.^{37,38} One employee remembered the bathroom door coming off its hinges, slamming him in the back, and sending him flying into a brick wall.³⁹ Another recalled feeling for a moment like he was flying

³⁷ McHenry County Blog (<http://mchenrycountyblog.com/2011/05/28/joplin-tornado-what-happened-at-the-att-story-across-from-walmart/>).

³⁸ Communications Workers of America (<http://www.cwadistrict7.org/CWA-Newsletters-2011/6-2-CWA-Newsletter-2011.htm>).

³⁹ Ibid.

and then the sensation of being crushed, before he was knocked unconscious. By the time the storm was over, building materials and other debris had pinned some of the employees, so much so that they were unable to move. The building had been completely demolished, and those who could free themselves went for help. One death occurred in the store that evening due to impact-related injuries, and the extent of survivor injuries there is unknown.

Similar to circumstances at the Dillon's store, employees and patrons of the Joplin Pizza Hut sought protection in the restaurant's cooler. As the tornado ripped through the restaurant, it completely demolished the structure. Five people died at the Pizza Hut (two employees and three customers). One of the employees held the door of the cooler closed with the bungee cord until he was thrown by the storm. All of the fatalities resulted from multiple blunt force trauma to the body.

As the backside of the tornado started to affect this area, the winds shifted to a westerly direction at the Home Depot. Strong pressure induced by the tornado's winds disconnected the store's roof from its concrete tilt-up exterior walls, causing the walls to become unstable. Almost all of the wall panels, except for a few around the store's loading dock, then collapsed, blown outward or inward depending on the direction of the winds. According to the Home Depot security manager, approximately 35 of the building's occupants took refuge in the training room located at the back of the store before the storm hit. Fortunately, the concrete wall panels adjacent to this refuge area collapsed outward, away from these occupants. A total of eight people lost their lives at the Home Depot. Store management reported that these individuals had entered the store through the lumber entrance just before the storm hit and were walking parallel to the store's front wall, which collapsed on them.

Two blocks to the north at the Walmart, strong wind-induced pressure around the southern portion of the building disconnected the metal roof system from the perimeter concrete masonry walls, causing the walls to become unstable and collapse. The structural damage at Walmart varied significantly from the south end to the north end of the building, due to the sharp wind gradient along the length of the building. Subjected to much lower wind speeds, the north end of the building sustained much less damage from the tornado.

Before the tornado hit, Walmart employees and patrons were encouraged to congregate at the back of the building in the "Site-to-Store" or layaway area, which served as the main refuge area for building occupants. While this area provided some protection for the 50 to 60 occupants located there, the area was structurally no different than most other areas in the store, and the tornado collapsed the adjacent perimeter wall inward and onto this refuge area. Three people lost their lives at Walmart. It is uncertain exactly where inside the store these victims were located. However, information from the store's emergency operations center indicated that they were likely close to the center of the store. All three fatalities were caused by blunt force trauma to the body. No information could be found on how many building occupants did not seek shelter (in the back of the store) or on the number of people injured.

Approaching Joplin's eastern city limits, the tornado veered in a southeasterly direction that put yet another highly populated residential area, as well as the newly built Joplin East Middle School, at risk (see Fig. 1-11). The middle school, built in 2009, was the newest engineered structure surveyed by NIST that was affected by the Joplin tornado. The school building included a concrete-walled gymnasium and a masonry-walled auditorium, both of which had long-span metal roofs. Surveillance videos facing the outside of the school showed that the tornado struck there at about 5:48 p.m. Darkness descended upon

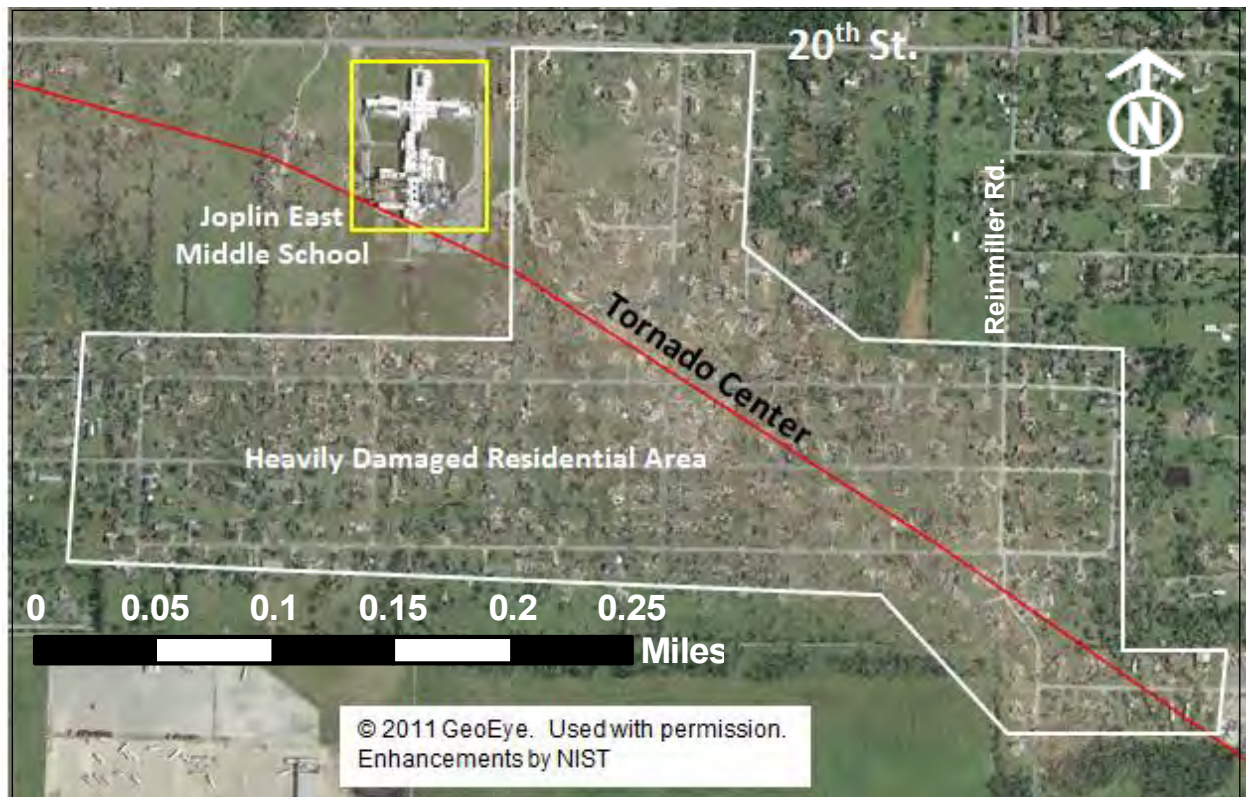

Figure 1–11. Aerial photo of damage to a residential area and Joplin East Middle School.

the area as the winds strengthened. Video footage of the gymnasium, on the south side of the school, showed ceiling lights swaying and bits of roofing material, including panels of metal roof decking, falling onto the gym floor as the winds began to increase. Later footage showed that failed roof trusses had fallen onto the gym floor and the western wall of the gymnasium had collapsed toward the interior of the building.

Similar collapses of the metal roof system and the exterior concrete masonry walls also occurred in the auditorium building. Fortunately, on that late Sunday afternoon, the school was not occupied at the time of the collapse.

The area outlined in white in Fig. 1–11 was the last of the heavily populated residential districts in Joplin to be damaged. Three people were killed there in detached homes and another person died in a vehicle. In a number of the residential structures that were heavily damaged in Joplin that day, the tornado broke apart the building's structural elements (i.e., roof, walls, and foundation). The tornado followed a southeasterly path and began weakening considerably as it left the Joplin area. The now smaller tornado continued through the City of Duquesne, crossed Interstate 44 near its junction with Highway 249. It then traveled another 12 miles through a sparsely populated rural area before ending about 5 miles north northeast of Granby, Missouri, for a total tornado track length of 22.1 miles (6 miles within the City of Joplin).

1.3 THE TOLL

In its wake, the May 22, 2011, Joplin tornado left 161 fatalities and more than 1,000 injuries. This EF-5 rated tornado was on the ground for approximately 6 miles and 15 min in Joplin, Missouri, and created a damage path as much as a mile wide. The tornado was the deadliest single tornado in the United States since the official NWS records began in 1950.

Of the 161 deaths, a total of 155 (or 96 percent) were due to impact-related injuries (generally identified as “multiple blunt force trauma to body” on the death certificates). Of these impact-related fatalities, 135 (or 87 percent) occurred inside buildings that were significantly damaged, and over half (58 percent) occurred in residential buildings, including the Greenbriar Nursing Home. Some contributing factors to these fatalities included the following: (1) the wind and wind-borne debris environment to which occupied buildings were exposed, (2) individuals’ delay in seeking “safer” or indoor protection, and (3) individuals’ age. First, all indoor, impact-related fatalities in Joplin occurred in buildings experiencing wind speeds estimated as EF-3 or higher, except for the two deaths that occurred in the Meadows Healthcare facility (which experienced wind speeds estimated as EF-1) and the six deaths that occurred within five single-family homes. Second, individuals’ delay in responding to the threat was due to a lack of awareness of the tornado or an inability to perceive personal risk associated with the tornado emergency. Third, a disproportionately higher number of people aged 60 years or older died or were injured as a result of this tornado, when calculating death rates (or the number of deaths within a certain age range per thousand people in that age range within the tornado’s damage path).

The damage to the built environment made this the costliest tornado on record, with losses approaching \$3 billion. The Joplin tornado damaged 553 business structures and nearly 7,500 residential structures; over 3,000 of those residences were heavily damaged or completely destroyed. Unlike many earlier tornadoes, which typically affected less populated or developed areas, the Joplin tornado affected a densely populated region that encompassed residential areas, a number of schools, large commercial facilities, and critical facilities. In addition, this tornado significantly damaged lifeline systems in the affected areas, including the regional electric power transmission and distribution infrastructure, numerous water and fire service lines and gas mains, and thousands of utility connections and meters. Also contributing to these losses was an estimated 3 million cubic yards of debris (enough to fill a football field 120 stories high). Wind-borne debris exacerbated the damage to the built environment and contributed to some of the 155 impact-related fatalities. The accumulation of debris also complicated the restoration of lifeline services as it impeded access by utility workers in the days following the tornado.

1.4 NIST’S JOPLIN TORNADO INVESTIGATION

Given the magnitude and consequences of this tornado, the National Institute of Standards and Technology (NIST) sent four engineers to Missouri on May 24–28, 2011, to conduct a preliminary reconnaissance.⁴⁰ Based on subsequent analyses of the data they collected and other criteria required by law and regulation, NIST Director Patrick Gallagher established a Team under the National Construction Safety Team (NCST) Act on June 29, 2011, to proceed with a more comprehensive study of the disaster. The establishment of this Team was announced in the Federal Register on July 19, 2011 (76 FR 42683).

⁴⁰ See http://www.nist.gov/el/disasterstudies/upload/Joplin_Reconnaissance_Presentation061511-2.pdf for more information about NIST’s preliminary reconnaissance in Joplin.

Additional information regarding the rationale for the technical investigation is provided in the investigation plan.⁴¹

NIST is a non-regulatory agency of the U.S. Department of Commerce. NIST technical investigations are focused on fact finding, not fault finding. No part of any report resulting from a NIST investigation into a structural failure or from an investigation under the NCST Act may be used in any suit or action for damages arising out of any matter mentioned in the report (15 U.S.C. 281a, as amended by Public Law 107–231).

1.4.1 Goals

NIST’s investigation of the Joplin tornado had two major goals. The first was to investigate the wind environment and technical conditions that caused fatalities and injuries; the performance of emergency communications systems and the public response to such communications; and the performance of residential, commercial, and critical buildings,⁴² designated safe areas in buildings, and lifelines.⁴³ The second goal was to develop findings and recommendations that can serve as the basis for:

- Potential improvements to requirements for the design and construction of buildings, designated safe areas, and lifeline facilities in tornado-prone regions;
- Potential improvements to guidance for tornado warning systems and emergency response procedures;
- Potential revisions to building, fire, and emergency communications codes, standards, and practices; and
- Potential improvements to public safety.

1.4.2 Objectives

The primary objectives of the NIST technical investigation of the Joplin tornado were to:

1. Determine the tornado hazard characteristics and associated wind fields in the context of historical data;
2. Determine the response of residential, commercial, and critical buildings, including the performance of designated safe areas;
3. Determine the performance of lifelines as it relates to the continuity of operations of residential, commercial, and critical buildings;

⁴¹ NIST Special Publication 1132, “Investigation Plan – National Institute of Standards and Technology (NIST) Technical Investigation of the Joplin, Missouri, Tornado of May 22, 2011,” available at http://www.nist.gov/manuscript-publication-search.cfm?pub_id=911000.

⁴² For example, hospitals, fire stations, police stations.

⁴³ For example, electrical power, natural gas, and water supply infrastructure and facilities.

4. Determine the pattern, location, and cause of fatalities and injuries, and associated performance of emergency communications systems and public response; and
5. Identify, as specifically as possible, aspects of current building, fire, and emergency communications codes, standards, and practices that warrant revision.

The technical investigation in support of these objectives spanned over 2 years. The objectives are addressed in this report in a chapter format. Chapter 2 supports objective 1 (determining tornado hazard characteristics and associated wind fields in the context of historical data). Chapter 3 supports objectives 2 and 3 (determining the response of residential, commercial, and critical facilities and the performance of lifelines as they relate to these facilities). Chapter 4 supports objective 4 (determining the pattern, location, and reported cause of fatalities and injuries, and associated emergency communications and public response). Finally, objective 5 (identifying aspects of codes, standards, and practices that warrant revision) is supported by all of the chapters in this report, and the investigation's findings and recommendations are summarized in Chapter 5.

This page intentionally left blank.

Chapter 2

TORNADO HAZARD CHARACTERISTICS

2.1 INTRODUCTION

Chapter 2 discusses the hazard characteristics and associated wind fields in the May 22, 2011, Joplin tornado and this storm’s historical context on local, regional, and national levels. Section 2.2 outlines the meteorological conditions immediately before and at the time of the tornado occurrence. Section 2.3 estimates the near–surface wind field of the Joplin tornado through both direct and indirect measurement techniques. In Sec. 2.4, the U.S. tornado hazard is discussed in detail with respect to tornado climatology and tornado–related losses including comparisons to the Joplin tornado. Section 2.5 assesses the EF Scale, the guidance for its application, and its implementation in the Joplin tornado and other significant tornado events.

2.2 METEOROLOGICAL CONDITIONS

2.2.1 Objective

Section 2.2 documents the meteorological/environmental conditions and the associated timeline of key events leading up to and during the Joplin tornado. It establishes the general factors leading to the development of the Joplin tornado, and serves as a baseline for understanding the Joplin tornado in a historical context. The discussion is largely based on watches, warnings, and meteorological information on the Joplin tornado provided by the NWS and siren information provided by the City of Joplin.

2.2.2 Joplin Environment and Timeline

Based on surface– and upper–air observations, the potential for severe weather in the Joplin area on May 22, 2011, was fairly evident. The upper levels of the atmosphere included low pressure, denoted in Fig. 2–1 by an “L” centered over the Dakotas. As air flows around low pressure in a counterclockwise direction in the northern hemisphere, the atmosphere above Joplin (red star) was experiencing southwesterly winds. Wind speed and direction in Fig. 2–1 are denoted by the “wind barbs” shown in blue; the nearest wind barb to Joplin is circled. The wind barbs point in the direction from which the wind is coming (from the southwest for the circled barb). Each long barb represents 10 knots,⁴⁴ each short barb, 5 knots, and each pennant, 50 knots. In the case of the circled barb near Joplin, the wind speed shown is 40 knots from the southwest (at a height of approximately 5,800 meters or 19,000 feet).

Surface analysis (Fig. 2–2) shows a warm front (red scalloped line) just west of Joplin (red star) near the time of the breakout of storms. A surface low (denoted by “L”) was just to the west of Joplin in extreme southeastern Kansas, with a dryline (orange scalloped line) extending southwest from the center of the low. These conditions can provide a focus for low–level moisture convergence that often initiate and sustain strong storms provided other severe weather parameters are in place (Church 1993).

⁴⁴ 1 knot = 1.15 mph = 0.514 m/s.

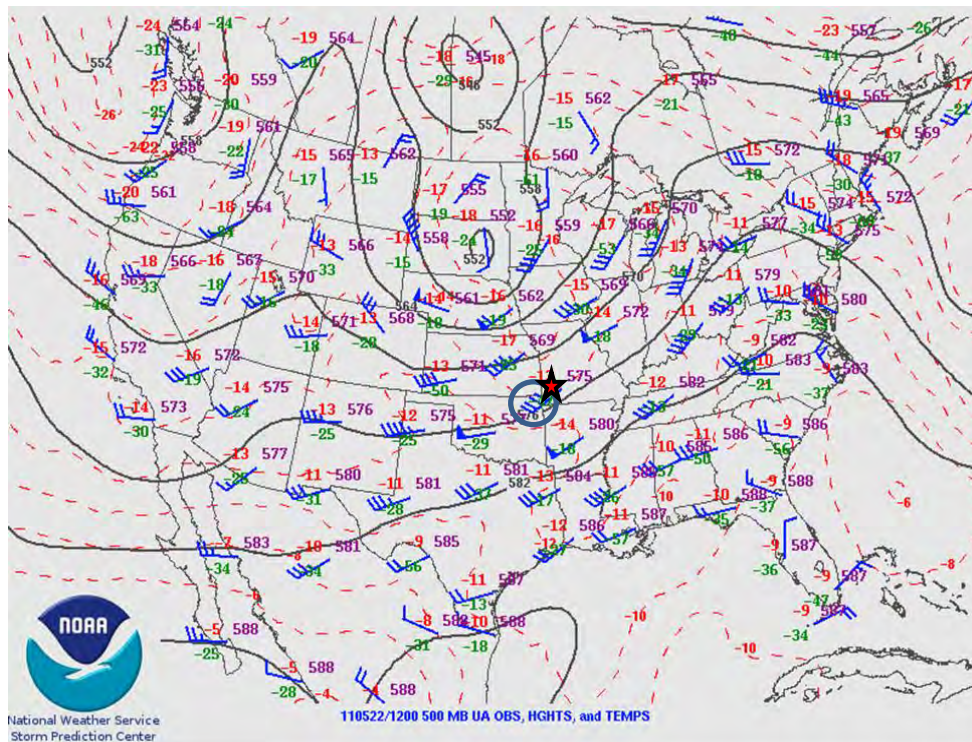

Source: NOAA. Enhancements by NIST.

Figure 2–1. 500 millibar (mb) analysis at 7 a.m. CDT (1200 Coordinated Universal Time (UTC) on May 22, 2011.

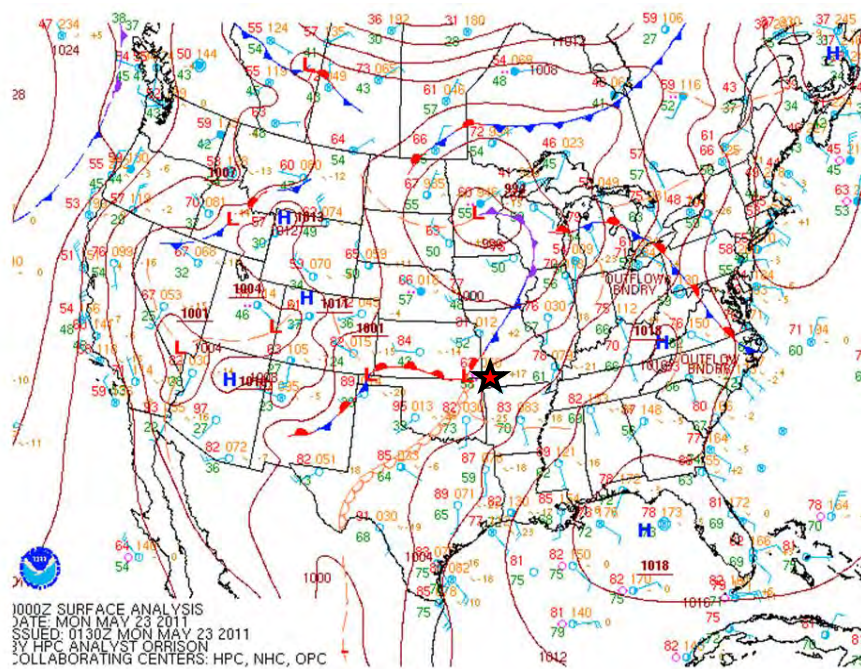

Source: NOAA. Enhancements by NIST.

Figure 2–2. Surface analysis at 7 p.m. CDT (0000 UTC, May 23, 2011) on May 22, 2011.

A balloon sounding (plot not shown) from the Springfield, MO NWS forecast office, 100 km (60 mi) to the east of Joplin, was launched at 7 PM CDT (00 UTC). From this sounding a calculated environmental convective available potential energy (CAPE) of nearly 4,000 joules per kilogram (J/kg) was made. CAPE is a vertically integrated measure of buoyancy, i.e., any positive CAPE indicates a potential for convective clouds to form. Tornadoic storms, however, also require a certain amount of low-level wind shear (e.g., the vector difference of the wind at 5,000 ft altitude minus the surface wind vector) to create the rotation necessary to form tornadoes. The balloon sounding indicated low-level shear of around 25 m/s (50 mph), more than adequate to support severe thunderstorms and tornadogenesis given the large amount of instability (CAPE).

Figure 2–3 shows a plot of CAPE versus wind shear values in Joplin compared with historical severe thunderstorm environments. The red line in Fig. 2–3 denotes a separation of “significant severe” environments from “non–significant severe” environments. Significant severe is defined in Brooks (2003b) as “having hail at least 5 cm in diameter, wind gusts at least 120 km/hr, or a tornado of at least F2 damage”. Based on the conditions, the Joplin environment was favorable for the production of severe thunderstorms, including tornadoes.

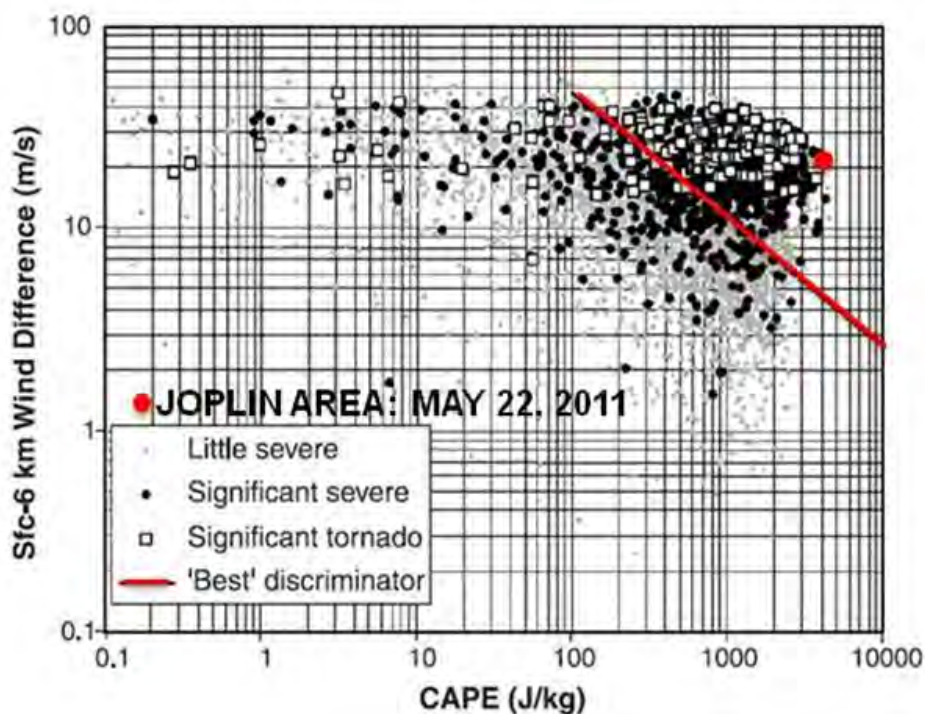

Source: Brooks et al. (2003b). Enhancements by NIST.

Figure 2–3. Wind shear and CAPE for severe thunderstorm environments. "Best Discriminator" line denotes areas to right and above as being more favorable for significant severe thunderstorms.

The severe weather environment described above was anticipated by the NOAA/NWS SPC. The tornado outlook issued at 1 a.m. CDT (0600 UTC) on May 22, 2011 included a “10 percent probability of strong tornadoes (EF–2 or greater) within 25 miles of a point” (Fig. 2–4) in the Joplin area. Also, throughout the day on May 22, the SPC issued three separate “Mesoscale Convective Discussions” for areas that included Joplin up to and including the time of the tornado. These Mesoscale Convective Discussions clearly pointed to an environment in the Joplin area that was favorable for the development of a significant severe weather event. Text from and links to the Mesoscale Convective Discussions are provided in Appendix A.

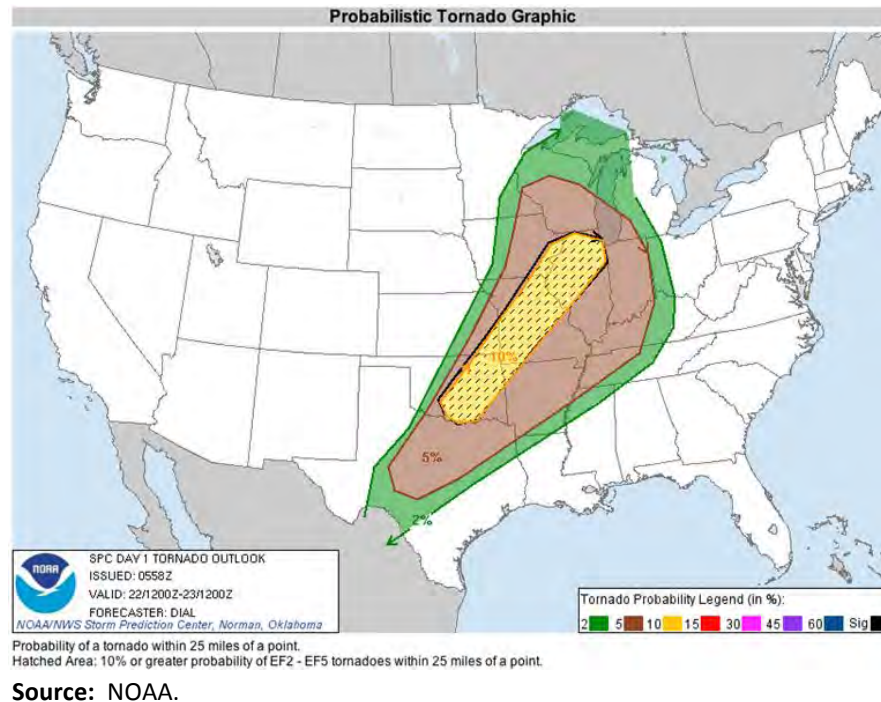

Source: NOAA.

Figure 2–4. Tornado outlook issued by NOAA’s Storm Prediction Center at 1 a.m. CDT (0600 UTC) on May 22, 2011.

At 1:30 p.m. CDT (1830 UTC), about 4 hours before the tornado struck Joplin, the SPC issued a tornado watch for a large portion of northwest Arkansas, southeast Kansas, eastern Oklahoma, and southwest and central Missouri (see Appendix A, Sec. A.2). Thunderstorms did develop in the Joplin area beginning between 4 and 5 p.m. (2100 and 2200 UTC).

In response to these storms, a series of tornado warnings for the Joplin area were issued by the NWS Forecast Office in Springfield, Missouri. The areas covered by these warnings are shown in Fig. 2–5. The May 22, 2011 timeline of tornado watches and warnings is shown in Fig. 2–6. Tornado Warning (TO.W) Polygon 30 was issued by the Springfield NWS office (Fig. 2–5) at 5:09 p.m. (2209 UTC), which included the northeast portion of Joplin. The first citywide warning siren in Joplin was sounded at 5:11 p.m. CDT (2211 UTC). The siren timeline is also illustrated in Fig. 2–6. For details on how people responded to and interpreted the warnings and sirens in Joplin, please consult Chapter 4.

A storm separate from the one that prompted TO. W 30 developed and a second tornado warning polygon⁴⁵ was issued by the Springfield office at 5:17 p.m. (2217 UTC) that included the entire city of Joplin (TO.W 31 in Fig. 2–5). Figure 2–7 shows radar images from 5:24 p.m. (2224 UTC) to 5:53 p.m. (2253 UTC). The issuance of TO. W 31 in Fig. 2–5 was based on the storm identified from radar in Fig. 2–7. The initial tornado touchdown, based on spotter reports, was at 5:34 p.m. (2234 UTC) southwest of the Joplin city limits. The tornado timeline is also illustrated in Fig. 2–6. The citywide warning sirens sounded again in Joplin at 5:38 p.m. (2258 UTC). Surveillance camera footage provided by Joplin City Schools indicated that the tornado struck Joplin High School at approximately 5:42 p.m. (2242 UTC) and Joplin East Middle School at approximately 5:48 p.m. (2248 UTC). The Springfield NWS office issued another warning polygon (TO.W 32) at 5:48 p.m. (2248 UTC) to extend the tornado warned area to the east of Joplin. The track of the Joplin tornado in comparison to the areas covered by the tornado warnings is shown in Fig. 2–5, and an estimated center of the tornado track based on the work in Sec. 2–3 is illustrated in Fig. 2–8.

The issuance of TO.W 30 and the sounding of the first sirens in Joplin occurred 25 and 23 minutes respectively before the first reported tornado touchdown at 5:34 p.m. (2234 UTC). However, the storm that prompted TO. W 30 did not produce a tornado and the warning only included a small portion of the city of Joplin.

The issuance of TO. W 31, which included the entire city of Joplin, occurred 17 minutes before (i.e., lead time of 17 minutes) the first tornado touchdown. The storm that prompted TO. W 31 went on to produce the tornado that affected the city of Joplin. The national average for tornado lead times was 15 minutes based on fiscal year (FY) 2011 data, and since the advent of the NWS NEXRAD (Next Generation Radar System) radars throughout the United States in the early to mid 1990's, lead time has been approximately 12 minutes on average.⁴⁶

It should be noted that Joplin was not in close proximity to NWS radars. Both the KINX (Tulsa) and KSGF (Springfield) radars were a considerable distance (approximately 100 kilometers or 60 miles) away from the storm. Even at the lowest beam elevation angle, 0.5 degrees, the information available at such distances relates to conditions at altitudes (approximately 1.5 kilometers or 0.93 miles above ground) that are orders of magnitude greater than what would be relevant to damage caused near the ground surface (in most cases under 20 meters or 66 feet). In addition, the *NWS Service Assessment* concerning the Joplin tornado found that "...low-level rotational intensification and the subsequent tornado occurred rapidly and that more continuous near-surface radar sampling and information were needed". Given the lack of detailed wind information available from the NWS radars, NIST used indirect methods to estimate the wind speeds experienced in Joplin during this event.

⁴⁵ See NOAA (http://www.srh.noaa.gov/images/bmx/aware/swaw_2010/web_version_pages_p6.pdf) for general description of warning polygons.

⁴⁶ NOAA (<http://www.osec.doc.gov/bmi/budget/11BiB/NOAA%20Performance.pdf>)

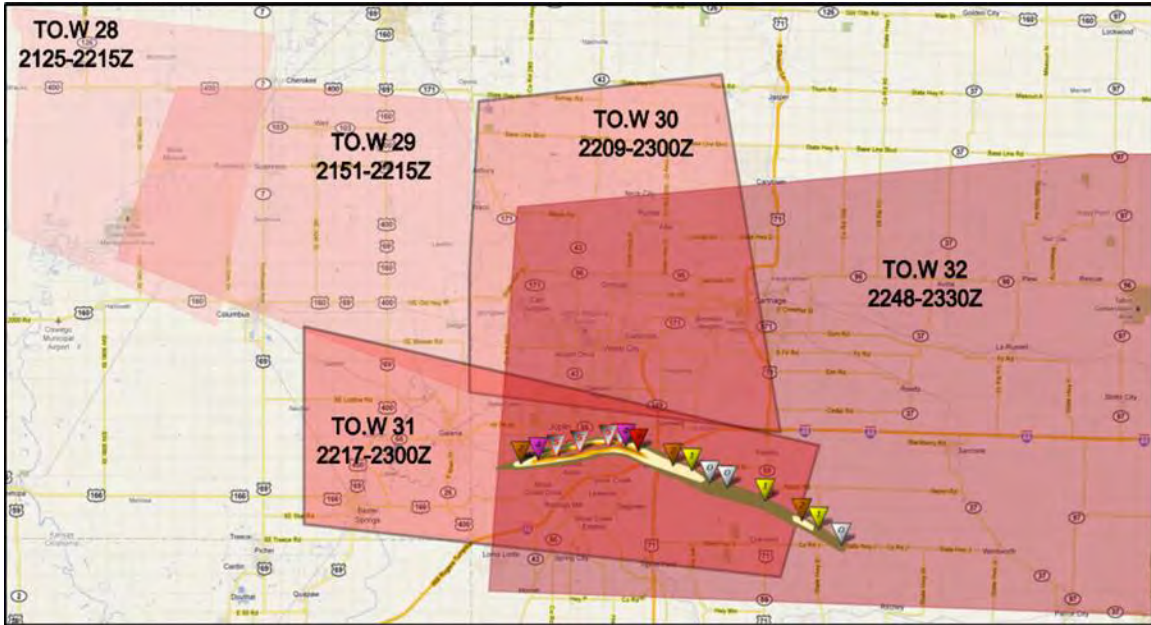

Source: NWS (2011).

Figure 2–5. Tornado warnings issued by the Springfield NWS office on May 22, 2011. Zulu time, or Z, in the figure is the same as UTC time (Z = UTC). Estimated NWS track of the Joplin tornado shown outlined in brown.

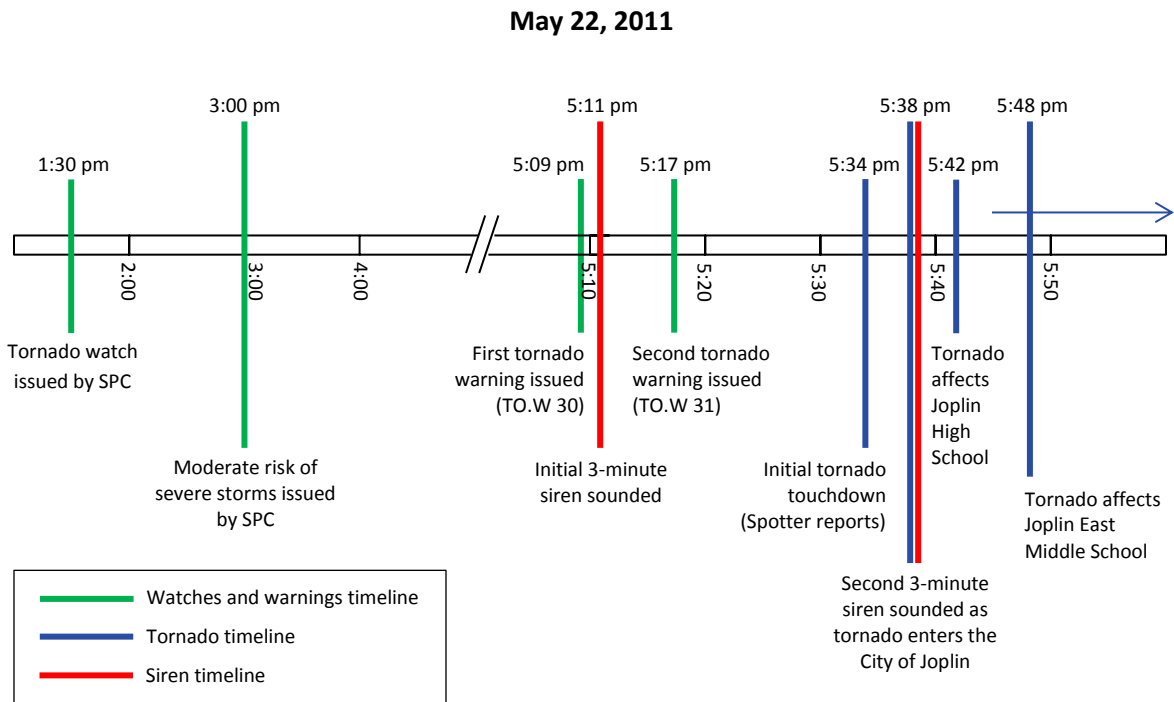
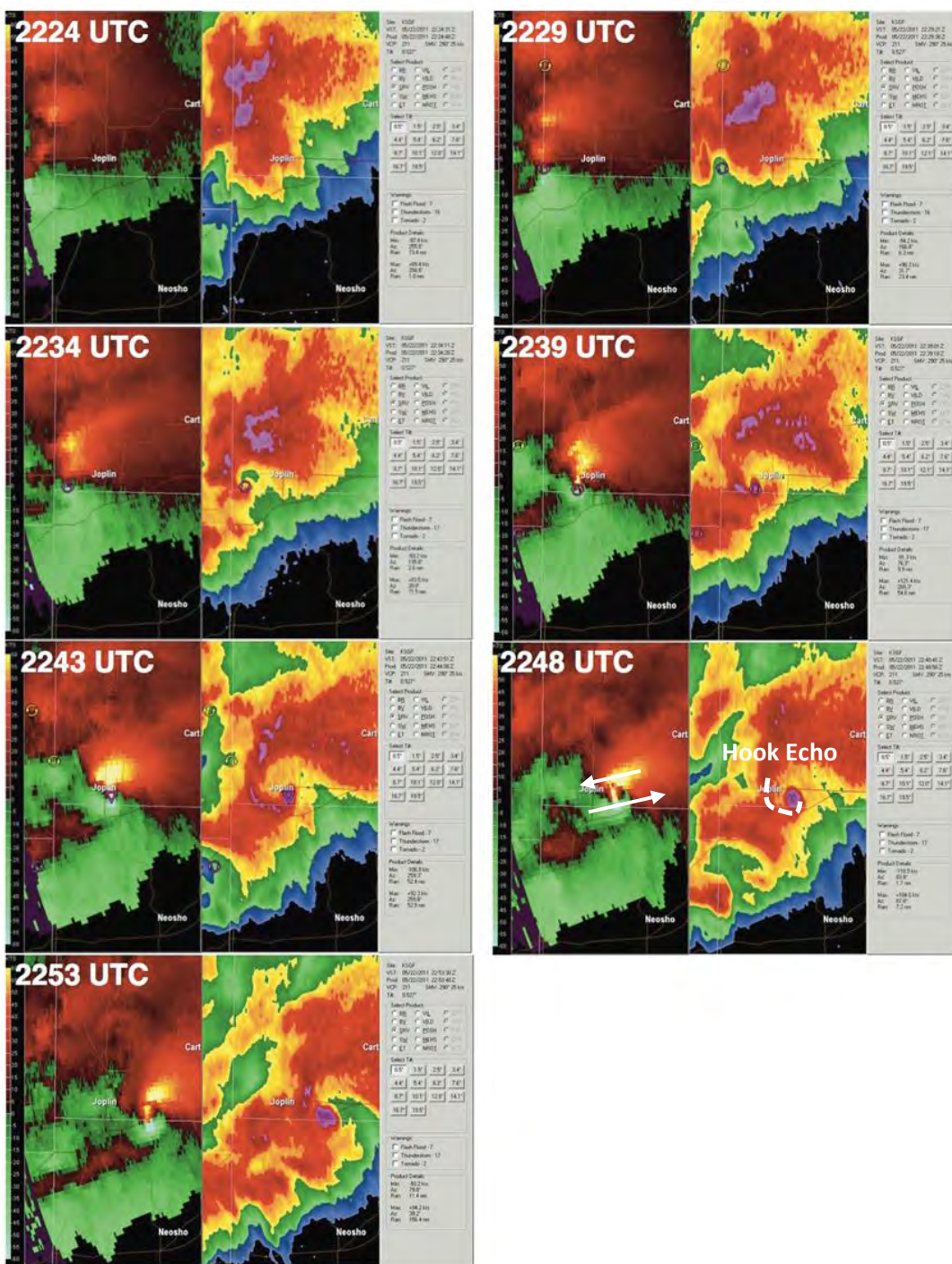

Figure 2–6. Timeline of watches, warnings, sirens, and the tornado itself.



Source: NOAA. Enhancements by NIST.

Figure 2–7. Radar reflectivity sequence from the Springfield radar. Radar reflectivity is the right panel and radial velocity is the left panel of each image. For radial velocity, red to yellow colors indicate winds receding from the radar (which is located to the east of Joplin), green to white colors indicate winds approaching the radar. These colors in close proximity suggest rotation and signify the approximate tornado position. A "hook echo" is seen in reflectivity images, also a possible indication of a tornado. These features are annotated in the 2248 UTC panel.

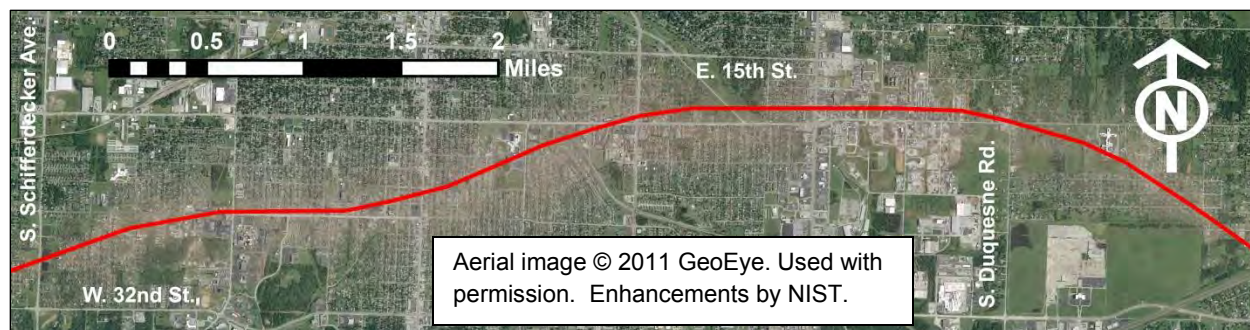

Figure 2–8. Center of Joplin tornado track as estimated by NIST.

2.3 NEAR–SURFACE WIND ENVIRONMENT

2.3.1 Objective

Given the lack of near–surface wind information provided by radar (Sec. 2.2) and of direct measurements of wind speeds (Sec 2.3.3) in the most heavily damaged areas in the Joplin tornado, indirect techniques were used to estimate the near–surface wind field. Two independent techniques were used: inference of wind speeds from observed damage using the EF Scale, and modeling of the wind field using a Rankine vortex model fitted to observed tree fall data. These estimates of the near–surface wind field are important for understanding the performance of buildings and structures as well as understanding this event in the context of tornado climatology and probabilistic hazard assessments. The wind speed estimates generated from these techniques are evaluated in relation to similar analyses reported in the technical literature. Section 2.3.2 discusses the general structure of a tornado wind field, Sec. 2.3.3 discusses direct wind speed measurements from the Joplin area on the day of the tornado, and Sec. 2.3.4 details the methods and analysis used for indirect wind speed estimation.

2.3.2 Tornado Wind–Field Regions

In general, the air flow regions in and around an idealized tornado can be thought of as the five separate regions illustrated in Fig. 2–9. Region **Ia** is termed the outer flow. This spiraling outer flow typically extends outward from the core (Region **Ib**) at least 1 km (Davies–Jones et al. 2001) and consists of air that approaches and rises around the core. The core, or Region **Ib**, surrounds the central axis of the tornado and extends outward to the radius of maximum tangential winds. The radius of the core region is typically tens to hundreds of meters (Davies–Jones et al. 2001).

Due to the stability of the core, there is limited entrainment of air into the core from Region **Ia**. Therefore, the core consists for the most part of air that has entered through the boundary layer (Region **II**) and corner region (Region **III**) or the upper region (Region **IV**). The boundary layer, Region **II**, consists of an inflow that is influenced by frictional interaction with the earth’s surface. Due to this interaction, the flow in the boundary layer tends to have a more radial (towards the tornado center) flow compared to the outer flow. The depth of the boundary layer is typically from 10 m to 100 m (Markowski and Richardson 2010). The effects of friction near the surface can actually increase tornado wind speeds in the boundary layer (Kosiba and Wurman 2010; Davies–Jones et al. 2001) and/or the corner flow region (Church 1993). Air that enters the tornado core from the boundary layer must first pass through the

corner region (Region III). This is a highly complex region where the flow must transition from a horizontal flow along the surface to a vertically upward flow, or “turn the corner,” in the presence of a tornadic vortex. Most heavily damaged areas in tornadoes have likely come in contact with corner flow and a large amount of wind-borne missiles and debris are generated in this region (Davies–Jones et al. 2001). Region IV, the upper flow of the tornado consists of the rotating updraft, or mesocyclone, of the parent thunderstorm.

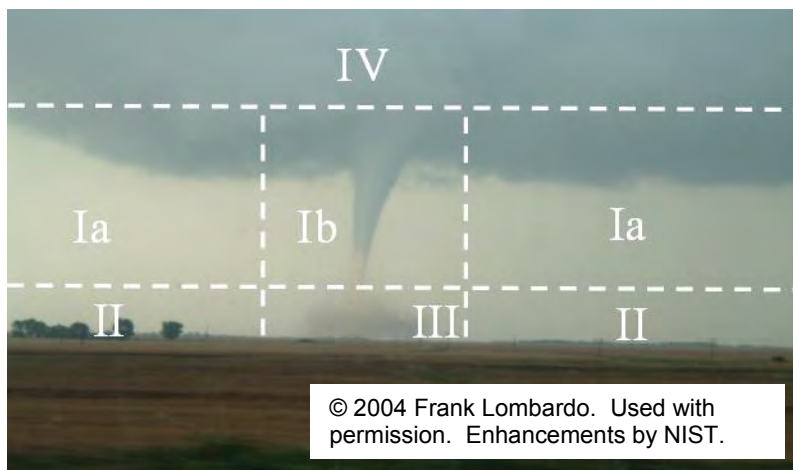

Figure 2–9. General tornado flow regions.

In general, the tangential velocity of the wind field, not including tornado translation (i.e., movement) or vertical wind speed, as it extends radially from the center of the tornado, can be described and estimated using a Rankine vortex model (ANS 2011). Although other vortex models exist (Wood and Brown 2011), the Rankine model has been used in a number of engineering applications (ANS 2011). The Rankine vortex is an idealized, axisymmetric vortex model, sometimes called a Rankine combined vortex. The wind speed at radius r , which is denoted as $V_{cir}(r)$, displays an increase from the center of the tornado outward to the radius of maximum wind (RMW) and a hyperbolic decay thereafter based on the decay exponent (ϕ). An illustration of a normalized Rankine vortex is shown in Fig. 2–10, and the mathematical description is shown in Eq. 2.1.

$$V_{cir}(r) = V_{max} \left(\frac{r}{RMW} \right)^\phi, r \leq RMW \quad (2.1)$$

$$V_{cir}(r) = V_{max} \left(\frac{RMW}{r} \right)^\phi, r > RMW$$

The maximum velocity at the RMW generated by the tornadic vortex (V_{max}), especially near the surface (Davies–Jones et al. 2001) can have both a radial (V_r , toward the center of the tornado) and tangential (V_θ) wind component, as shown in Fig. 2–11. The Rankine vortex model can be used to explain both components (Potvin et al. 2009).

The translation speed (V_T) is defined as the speed of the tornado movement. The translation speed represents movement of the tornado in the translation direction (θ_T) and is used to estimate a translation velocity. This velocity is additive to the velocity estimated from the Rankine model. In other words, the

total velocity at any point in the tornado wind field is equal to the vector sum of the translation, radial, and tangential velocities (Fig. 2–11).

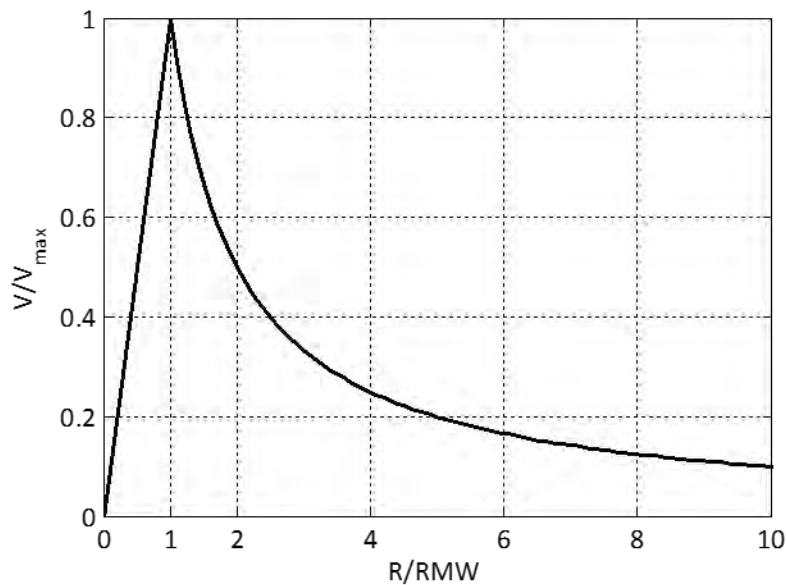

Figure 2–10. Normalized Rankine vortex showing maximum wind speed at RMW ($\varphi = 1.0$).

With the information described above, an estimate of the resultant wind speed, V , and associated wind direction, β , can be made. The wind direction (β) is measured clockwise with zero degrees being from true north. The coordinates and sign convention are illustrated in Fig. 2–11, and will also be used in modeling of the Joplin tornado wind field (Sec. 2.3.4).

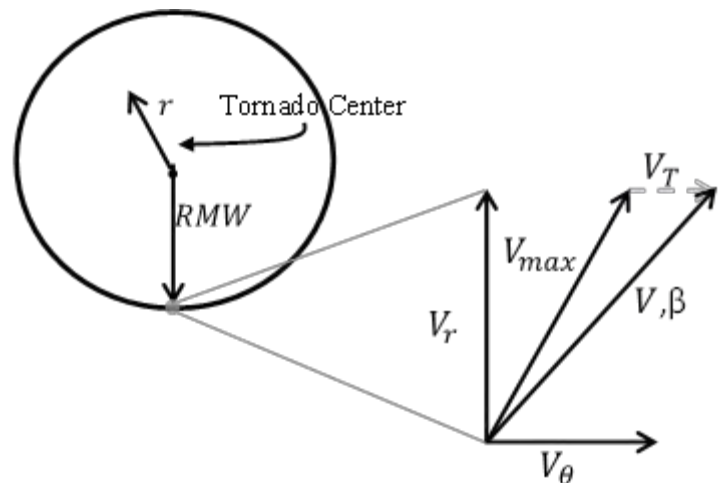
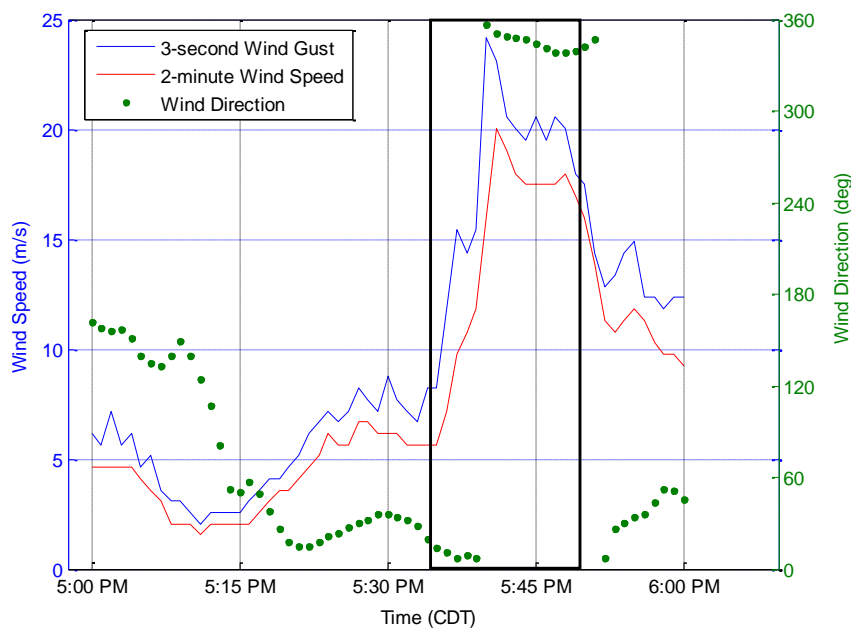

Figure 2–11. Generalized wind vector for a point denoted by the small gray circle. RMW is distance from gray circle to “tornado center.”

2.3.3 Direct Wind Speed Observations

2.3.3.1 Wind Environment

The Joplin Airport Automated Surface Observing System (ASOS) station (call letters KJLN) was located 5 miles to 6 miles north of the tornado as the storm passed through Joplin, well outside of the damaged area. However, even at this distance, measurements from KJLN suggest that the wind speeds at this location may have been affected by the mesocyclone of the parent thunderstorm (Region IV) for approximately 15 minutes, from 5:34 p.m. CDT to 5:49 p.m. CDT (2234 to 2249 UTC). This time period is “boxed” in Fig. 2–12, which shows the time histories of wind speed and direction recorded by the KJLN anemometer at a height of 10 m above the ground. The environment appears to begin being affected around the approximate time of the tornado touchdown at 5:34 p.m. CDT (2234 UTC). The time of touchdown is shown as the left edge of the black box in Fig. 2–12. The wind speed increases to a maximum 2 minute average value reaching 20.0 m/s (44.7 mph), and a maximum gust wind speed (3–second gust) over 24.0 m/s (53.7 mph). The wind direction backs (turns counterclockwise) from approximately 160 degrees (from the south–southeast) around 5 p.m. CDT (2200 UTC) to about 345 degrees to 360 degrees (from due north to north–northwest) during the time when the tornado was on the ground. This wind direction is coincident with inflow toward the positions of the mesocyclone and the tornado relative to KJLN at these times.



Data Source: NOAA. Analysis by NIST.

Figure 2–12. Time history of mean and gust wind speed and mean wind direction from the Joplin ASOS station (KJLN) from 5 p.m. to 6 p.m. CDT (2200–2300 UTC), on May 22, 2011. Boxed area is approximate time when the tornado was on the ground in Joplin.

The ASOS station at the Joplin Airport was the only identified “direct” wind measurement near the Joplin tornado. However the anemometer did not sample tornadic wind speeds and was well outside the damaged area. Also, as discussed earlier, no information could be gained from the NWS radars about wind speeds close to the surface. The lack and subsequent need of accurate, rugged near-surface (< 20 meters or 66 feet) wind speed measurements in tornadoes has been noted in the literature for over 20 years (NRCO, 1993). Therefore, methods of indirect wind speed estimation in the tornadic environment were used as described in the following section.

2.3.4 Indirect Wind Speed Estimation

2.3.4.1 Observed Damage (EF Scale)

EF-Scale Process—

The Enhanced Fujita (EF) Scale is used to estimate and then rate the intensity of the maximum wind speeds in a tornado based on observed damage. The scale ranges from EF-0 to EF-5, with EF-5 being the most intense. The EF-Scale process involves observing damage to a specific element of the environment, called a damage indicator (DI). The scale has 28 DIs, ranging from small outbuildings, one- or two-family residences, schools, and shopping malls to electrical transmission lines and softwood and hardwood trees. Corresponding to each of the 28 DIs are several degrees of damage, or DODs. The full list of DIs and corresponding DODs is available (Texas Tech University, 2006). DODs range from the initiation of damage to complete destruction (i.e., a progressive wind damage sequence). There is a range of wind speeds associated with each DOD. Each range includes an expected wind speed associated with ‘normal’ conditions, as well as lower and upper bounds to account for different conditions (i.e., weaker or stronger wind resistance than typical construction, respectively). These wind speed values were developed by wind engineers and meteorologists who were considered experts in the field of tornadoes. Once a wind speed value is chosen for a particular DI and DOD, an EF-Scale number is assigned based on Table 2-1. Additional information on the EF Scale and its predecessor, the Fujita Scale (F Scale), is provided in Sec. 2.5. It should be noted that the EF Scale implicitly represents a lower bound estimate to the wind speed values that cause damage. For example if a transmission line is expected to fail at 49 m/s (110 mph) and a transmission line failure is observed in the field, it is possible that the actual wind speeds were > 49 m/s (110 mph). The transmission line with an expected failure wind speed of 49 m/s (110 mph) can provide no additional information on the wind speeds that may have occurred. This issue is most apparent when attempting to rate strong tornadoes in the EF Scale. For example, in the EF Scale document, there are currently only five (5) DI’s where an expected value of wind speed would give an EF-5 rating (greater than 89 m/s or 200 mph).

Selected NIST-Surveyed Structures and Comparisons with Other Studies—

Damage to selected engineered structures surveyed by NIST following the tornado was analyzed using the EF-Scale rating process. The damage to these structures is described in detail in Chapter 3. They were assigned an EF number for the purposes of this report using ground survey data and aerial photographs. These EF numbers were compared with those developed by other researchers and practitioners who surveyed the same structures after the Joplin tornado. In some cases, a single large building had levels of damage that varied significantly across the length of the structure. Current EF Scale guidance does not address how to rate large buildings with varying DOD.

Table 2–1. Enhanced Fujita Scale.

EF Number	Wind Speed (mph)	Wind Speed (m/s)
0	65–85	29–38
1	86–110	38–49
2	111–135	50–60
3	136–165	61–73
4	166–200	74–89
5	200+	89+

One example that demonstrates the challenges in assigning definitive DODs for large structures involves the Walmart (Store #59) located at 1501 South Range Line Road in Joplin. This large building was 573 feet (175 meters) long, oriented along a north–south axis. The building was located north of the center line of the tornado track. The southern part of the building, which was closer to the center of the tornado, suffered extensive damage, while the northern part of the building experienced much less damage as shown by the aerial photo in Fig. 2–13.



Figure 2–13. Aerial photo of Walmart Store #59 showing extensive damage to the southern (bottom) half of the building.

Under the EF scale guidance, this type of building is classified as DI 12, a “Large, Isolated Retail Building.” However, which DOD should be selected is less than clear. The structure could fall into either DOD 6, “inward or outward collapse of exterior walls,” which occurred in the southern half of the building, or DOD 7, “complete destruction of all or large sections of the building,” which could apply based on Figure 2–13. However a ground level picture (Fig. 2–14), reveals that some of the southern portion of the structure remained in place and suggests a DOD less than 7. The expected wind speeds (and lower/upper bounds) for DOD 6 and DOD 7 for DI 12 are 118 mph (98/158) and 147 mph (110/201), respectively. Consequently, assigning a specific DOD and an associated wind speed becomes somewhat subjective. Since the damage to the Walmart clearly exceeded DOD 6 and didn’t quite meet DOD 7 for a portion of the building, a point estimate of 140 mph \pm 15 mph was assigned. This made the estimated lower bound 125 mph, a value that could still account for DOD 6 while falling within the bounds of DOD 7. The upper bound, 155 mph, still falls within the range of DOD 6 wind speeds, and sits squarely within the wind speed range associated with DOD 7.



Figure 2–14. Elevation view of southwest-facing wall of Walmart Store #59.

Table 2–2 shows the wind speeds and associated EF numbers estimated by NIST using the EF Scale at the Walmart and the locations of several other NIST–surveyed buildings. NIST’s estimates were compared with those of other researchers and practitioners who also used the EF Scale (FEMA 2012; Prevatt et al. 2012; Marshall 2012; and Karstens et al. 2012), as shown in Table 2–2, and with estimates by Coulbourne and Miller (2012), which were back-calculated from observed failures of specific building components or systems.

Although the DIs used in the estimates were the same among all surveyors, there were considerable variations in the estimated DODs, estimated wind speeds, and final EF–Scale ratings. The varying estimates of damage and wind speed suggest that there is ambiguity and subjectivity in the current version of the EF Scale and its application, even among experienced researchers and practitioners.

Residential Construction—

Based on a database created by Pictometry International Corporation (used with permission), NIST determined there were approximately 7,400 residential structures estimated to have been damaged due to the Joplin tornado. The database separated damage levels into four classes (light, medium, heavy/totaled,

Table 2–2. Estimated wind speeds for NIST–surveyed structures using EF Scale.

NIST–Surveyed Structure	Damage Indicator (DI)*		Degree of Damage (DOD)**		Estimated Wind Speed (mph)		Estimated EF Number	
	NIST	Other	NIST	Other	NIST	Other	NIST	Other
Walmart	12	12 ^{a,d}	6–7	6 ^a , 7 ^d	140 ± 15	173 ^d	3	4 ^{a,d}
Home Depot	12	12 ^a	6–7	7 ^a	150 ± 15	N/A	3	4 ^a
Franklin Technology Center	15	15 ^d	9	9 ^d	150 ± 15	153 ^d , 143 ^e	3	3 ^{d,e}
SJRM (East/West Towers)	20	20 ^{a,c}	7	10 ^{a,c}	140 ± 15	148 ^c	3	3 ^{a,c}
Joplin East Middle School	16	16 ^d	8–9	7 ^d	140 ± 15	125 ^d , (137–164) ^b	3	2 ^{a,d} , 3 ^b
Joplin High School	16	16 ^{a,d}	8–9	11 ^a , 9 ^d	140 ± 15	120 ^b , 139 ^d , 158 ^e	3	2 ^b , 3 ^{a,d,e}

*DI numbers: 12, large, isolated retail building; 15, elementary school (the Franklin Technology Center was not an elementary school but was a building of similar construction); 16, junior or senior high school; 20, institutional building.

**DOD numbers: see Texas Tech University 2006 (Available online at <http://www.depts.ttu.edu/nwi/Pubs/FScale/EFScale.pdf>)

a. FEMA 2012.

b. Coulbourne and Miller 2012. (Estimated wind speed values back-calculated from)

c. Prevatt et al. 2012.

d. Marshall 2012.

e. Karstens et al. 2012.

Key: SJRM, St. John’s Regional Medical Center.

demolished). These damage classes were estimated by analyzing the differences between pre- and post-storm aerial imagery (orthorectified and oblique) of the Joplin area.⁴⁷ The damage classes estimated for building footprints in part of Joplin are shown in Fig. 2–15. The numbers of structures assigned to each class citywide are listed in the last row of Table 2–3. Wind speed statistics and numbers of structures estimated for residential damage levels using EF Scale.

To correlate the damage classes with the EF Scale, 10 structures within each damage class were randomly selected and assigned an EF rating using the EF Scale process. The 10 structures in each damage class were assumed to be representative of the entire population of structures within each class. The summary statistics for each damage class are shown in Table 2–3, along with an EF number corresponding with the average wind speed within each class. As expected, as the damage classes increase in intensity, the estimated wind speeds (and EF numbers) increase as well. The mean wind speeds for the damage classes were as follows: 78 mph (EF–0) for “light,” 93 mph (EF–1) for “medium,” 117 mph (EF–2) for “heavy/totalled,” and 144 mph (EF–3) for “demolished.”

⁴⁷ E. Stitz, Regional Technical Manager – Central Region, Pictometry®. Personal Communication, October 2012.

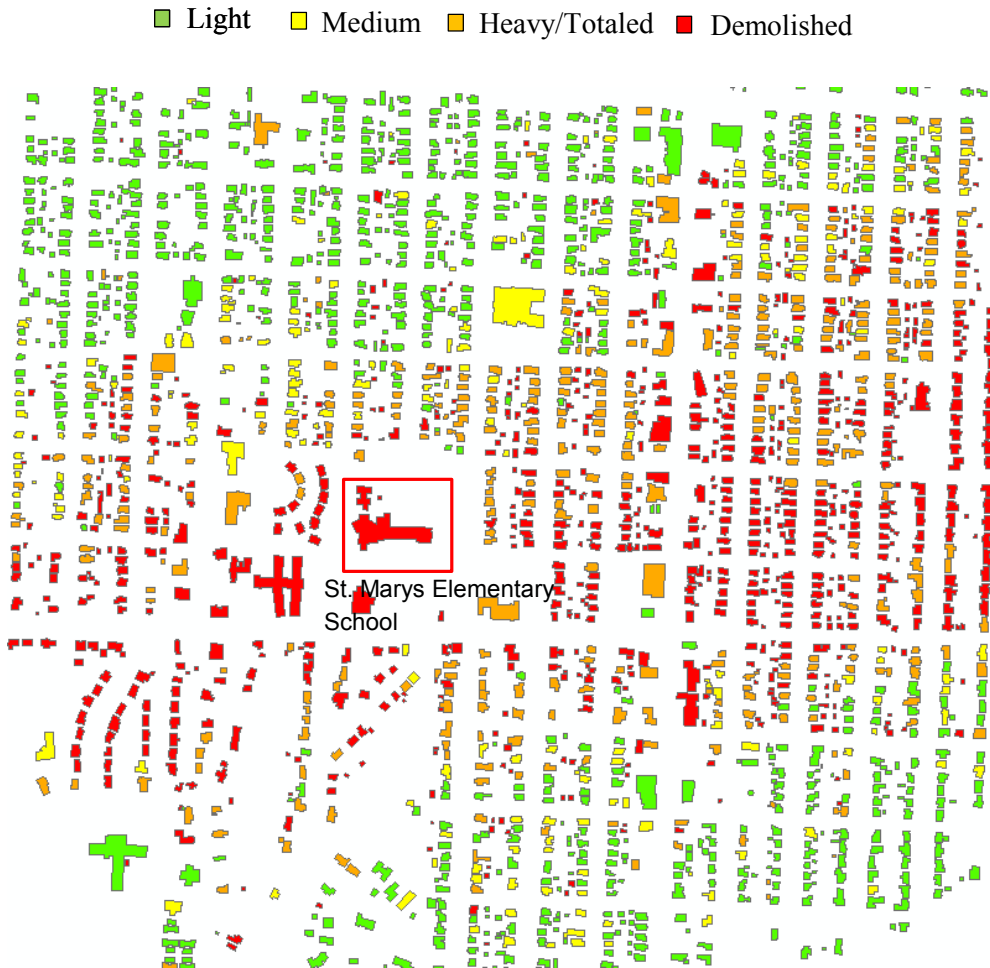

Data Source: Pictometry®. Used with permission.

Figure 2–15. Building footprints in part of Joplin showing damage classes. St. Mary’s Catholic Elementary School (red box) shown for reference. Area shown is approximately 1.0 miles west to east and 0.8 miles north to south.

Table 2–3. Wind speed statistics and numbers of structures estimated for residential damage levels using EF Scale.

Statistics	General Damage Classes			
	Light	Medium	Heavy/Totaled	Demolished
Mean wind speed – mph (m/s)	78 (34)	93 (42)	117 (52)	144 (64)
Standard Deviation – mph (m/s)	8 (3.6)	15 (6.7)	11 (4.9)	23 (10)
Range – mph (m/s)	65–85 (29–38)	85–120 (38–54)	95–130 (42 – 58)	110–175 (49–78)
Average EF Number	0	1	2	3
No. of Residential Structures ^a	3,498	732	1,119	2,062

a. Data source: Pictometry®. Used with permission. Analysis by NIST.

Residential structures categorized as “demolished” had the highest range of estimated wind speeds (110–175 mph or 49–78 m/s) and the most variable wind speeds (23 mph or 10 m/s standard deviation) according to the EF estimates. Marshall et al. (2012) rated over 7,000 residential structures affected by the Joplin tornado using pre- and post-storm information and rated 22 structures as sustaining EF-5 damage. This small number of structures relative to the total number of damaged structures is not out of line with the estimates from the sample rated by NIST, assuming a normal distribution for the wind speed statistics shown in Table 2–3. A table that includes all 40 of the structures rated using this method is provided in Appendix B. A second indirect method (i.e., tree fall) used to estimate wind speeds in the Joplin tornado is discussed in the next section.

2.3.4.2 Tornado Wind Field Model

Background—

Estimating wind speeds from tree fall was first attempted using a Rankine vortex model (Sec. 2.3.1) in Europe by Letzmann (Beck and Dotzek 2010). Hardwood (e.g., oak, maple, birch, ash) and softwood (e.g., pine, spruce, fir, hemlock) trees constitute two of the DIs in the EF Scale, with degrees of damage ranging from small limbs broken to debarking of the tree. Detailed analysis performed by Letzmann based on tree fall went largely unexplored until recently (Holland et al. 2006; Bech 2009; Beck and Dotzek 2010; Karstens et al., 2013), as questions regarding estimating wind speeds from damage persist (Dotzek 2009). Recent studies have incorporated (along with the Rankine model) a detailed tree breakage model that takes into account such parameters as crown height and width and tree spacing as well as parameters conveying the tree’s resistance to load (in this case wind load) and terrain characteristics. For example, in Holland et al. (2006), both the tree fall and wind field models were used in a simulated case where tree-specific parameters were known.

Model Background, Assumptions, and Limitations—

As mentioned in Beck and Dotzek (2010) and by Peterson (2003) a limited number of studies have been performed on specific types of trees to test their resistance to wind. In addition, since most studies are undertaken in forests, it is difficult to apply them to tree falls in urban settings due to a number of factors including root growth, spacing between trees, and varying numbers of species (Peterson, 2003). Variability in tree characteristics (i.e., spacing, soil conditions, tree dynamics, etc.) therefore has not been taken into account in this study. Due to these uncertainties, an average critical tree fall wind speed (i.e., the average wind speed when trees fall) as suggested by Beck and Dotzek (2010) was used in construction of the Joplin tornado wind field model.

In the initial stages of the Joplin tornado touchdown, multiple vortices were documented by videos, photos and eyewitness and spotter reports.⁴⁸ Analysis of tree fall patterns near the beginning of the tornado track as shown in Fig. 1–4 indicates at least five to six vortices were present in early stages of the tornado. Where multiple vortices clearly occurred in the early stages of the tornado, wind speeds were not modeled. It is acknowledged that the multiple vortices may have been responsible for some of the highest actual wind speeds in the Joplin tornado.

⁴⁸ NOAA (www.crh.noaa.gov/sgf/?n=event_2011may22_survey).

The Rankine vortex model used is a simplification of the actual flow fields. The Joplin tornado possessed multiple vortices when it began and may have been a two-celled tornado structure (Wood and Brown, 2011) with a stagnant core as it progressed through Joplin (Karstens et al., 2013). This two-celled structure is not assumed in the Rankine model. It is also likely that the Joplin tornado had asymmetric velocity patterns and significant variations that were a function of time and space, as has been identified in numerous other tornadoes (e.g., Wurman and Gill 2000).

No terrain corrections were performed, although surface elevation changes such as hills or valleys may channel or reduce the flow and likely alter the tornado vortex dynamics (Lewellen 2012). In addition, no near-surface debris effects were considered, the vertical profile of the horizontal wind speed was assumed to be uniform, and the horizontal wind speeds were assumed to be representative of a “peak” (i.e., 3-second gust) wind speed. No vertical wind speeds were considered, but are another topic for future research as noted by Van de Lindt (2013), as they may add a significant component to the wind speed and adversely affect wind loading on structures.

Joplin Tornado Model Initialization—

A wind field model using a Rankine vortex was developed using a number of parameters as input variables. An initial range was used for each of the input variables to account for uncertainty. The justifications for the parameter ranges are discussed after a brief description of each input parameter:

- Translation speed, translation direction and tornado location (V_T , θ_T , X , Y): These parameters represent the speed and direction of tornado movement as well as the location of the center of the tornado (also described in Sec. 2.3.2).

The average translation speed, V_T , was estimated to be around 30 mph (13.4 m/s). This speed is based on radar information provided by NWS Springfield and on surveillance video provided by Joplin City Schools that contained time-stamp information for two schools approximately 3 miles (4.8 km) apart. Based on the time stamps it took approximately 6 minutes for the tornado to travel between those two schools, for an average V_T of 30 mph (13.4 m/s). There was some variability in V_T noted in the NWS radar information. This variability is included in the model as ± 5 mph (2.2 m/s).

The translation direction, θ_T , and associated initial tornado center location (X , Y) were inferred from the NWS radar information and visual inspection of the damage swath from aerial photos. The overall tornado translation direction is illustrated later in Fig. 2–21. In addition, the location of the tornado center was also compared to locations at which interviewees mentioned experiencing a period of strong wind speeds, a relative calm, and then a subsequent increase in wind speeds. These reports were interpreted as references to the tornado “eye” (Burgess et al. 2002), an area of relatively calm winds within the tornado vortex that is noted in larger tornadoes. This relatively calm area is illustrated in the Rankine vortex model near $R/RMW=0$ in Fig. 2–10. The location of the tornado center was slightly modified, if necessary, to take into account general locations where interviewees reported experiencing the tornado eye. Also, in areas where the tornado maintained a consistent direction (based on damage patterns) for a relatively long period of time, the tornado center was assumed to pass near the “convergence line” in the tree fall patterns. The convergence line will be discussed later in this section.

- Alpha (α): This is the angle between V_r and V_{max} in Fig. 2–11. The angle is used to calculate radial and tangential components as described in Sec. 2.3.2.

Initial ranges for α were based on comparing general tree fall patterns described in the literature (Beck and Dotzek 2010; Holland et al. 2006) with the patterns observed in Joplin. This comparison suggested an α value of between 0 and 90 degrees. Typical engineering models of tornado wind flow (ANS 2011) assume that $\alpha = 90$ degrees, or a purely tangential flow. Therefore a range from 0 degrees to 90 degrees was initially set for α .

- Phi (ϕ): Phi is the decay exponent of the Rankine vortex (described in Sec. 2.3.2).

The value of ϕ used in tree fall studies has typically been 1.0, on the basis of conservation of momentum (Beck and Dotzek 2010). However, in studies of natural vortex phenomena this exponent was found to be less than one. In fact, multiple studies of both tornadoes (Bluestein 2007; Bluestein et al. 2003; Kosiba and Wurman 2010; Wurman and Alexander 2005) and hurricanes (Mallen et al. 2005) have shown exponents generally ranging from 0.5 to 0.7. For this study, the initial range of ϕ was 0.4 to 1.0.

Radius of maximum wind (RMW): This refers to the radius from the tornado center to maximum wind speed (described in Sec. 2.3.2). Values of RMW were initially estimated from the width of significant damage from aerial photos in the city of Joplin. Half the width of the significantly damaged area was used to set initial values of RMW . Therefore values of RMW varied along the tornado path proportional to the widths of the damaged areas.

- Rotation–translation ratio (G_{max}): This is the ratio between the maximum wind speed from the Rankine vortex model, V_{max} , and the translational wind speed, V_T . Similar to α , initial ranges for G_{max} were based on comparing tree fall patterns in previous literature and other tornado events (Beck and Dotzek 2010; Holland et al. 2006; Bech 2009) with the patterns observed in Joplin. The prior studies suggested a G_{max} value between 3.0 and 5.0. Letzmann (Beck and Dotzek 2010) set an upper limit of G_{max} at approximately 6.0. Therefore a range of G_{max} from 3.0 to 6.0 was initially set.
- Critical wind speed (V_{crit}): This is the average wind speed needed to cause a tree to fall.

Initial ranges for V_{crit} were estimated using a combination of information from Peterson,⁴⁹ EF–Scale information regarding tree damage (TTU 2006), and measured wind speed data from a windstorm that affected Joplin on May 8, 2009 that had a measured peak wind speed of 85 mph (37 m/s). The measured wind speed data were coupled with observer relayed storm reports denoting tree fall in the Joplin area.⁵⁰ The initial range of V_{crit} was set at 70 mph (31.3 m/s) to 110 mph (49.2 m/s).

- Maximum wind speed (\hat{V}): In the model, the overall maximum wind speed is calculated using G_{max} (related to the maximum wind speed from the Rankine model) and V_T . This calculation is shown in Equation 2.2.

⁴⁹ C. J. Peterson, Personal Communication, May 2012.

⁵⁰ NOAA (http://www.spc.noaa.gov/climo/reports/090508_rpts.html).

$$\hat{V} = (G_{max} + 1)V_T \quad (2.2)$$

Given the initial ranges of G_{max} , the maximum wind speed using Eqn. 2.2 for the Joplin tornado could be no more than 245 mph (110 m/s) and no less than 100 mph (45 m/s).

Grid development

In order to enable the calculation of wind speed and direction at specific points throughout Joplin as well as to compare outputs of the wind field model with tree fall observations in Joplin, a grid system was created. Each grid point represented a point (i.e., tree) in the model where a time history of wind speed and direction can be estimated, along with a tree fall direction. Grid points were initially located 0.02 miles (about 106 ft or 32 m) apart to be consistent with tree fall observations in Joplin (shown later in Table 2–4) and subsequently to determine Rankine model parameters at specific locations as defined in Appendix D Table D–1. Once these parameters were determined the grid was widened to 0.05 miles to account for the uncertainty in the tornado center location as well as for computational speed. Figure 2-16 illustrates grid points spaced 0.05 miles (264 ft, 80 m) apart throughout Joplin. The origin of the grid is located along Schifferdecker Ave ¼ mile (approximately 400 m) south of the Schifferdecker Ave. and 32nd St. intersection. The grid extends 6.2 miles east and 2.0 miles north. The eastern end of the grid was located approximately along Kenser Road. The boundaries of the grid were chosen to enable modeling of the tornado throughout Joplin. Additional information on development of the grid and coordinate system is provided in Appendix C.

Tornado center translation through grid

Starting at the estimated beginning of the tornado track, the center of the tornado was “moved” throughout Joplin. The tornado center was moved in increments of 0.01 miles (about 15 m or 50 ft) in the x–direction and a corresponding distance in the y–direction based on the translation direction, θ_T , in comparison to 270 degrees (from due west) as shown in later in Fig. 2–21. For example, if θ_T was 250 degrees, the y–direction movement would be 0.01 miles $\times \tan^{-1}(270 - 250)$. The tornado center moves this distance at the translation speed of the tornado, V_T . From the information above, a time step can be calculated. For example, advancing the tornado 0.01 miles moving at 30 mph (13.4 m/s) gives a time step of 0.01 miles $\times (1/30 \text{ mph}) \times 3,600 \text{ s} = 1.2 \text{ s}$. An example of the Rankine model translating through a generic 0.05–mile–spaced grid point system is shown in Fig. 2–17. The outputs and results of moving the tornado through the grid are discussed in the next section, as are the changes in translation direction throughout the Joplin tornado.

Full factorial design

All combinations of parameters were input into the Rankine vortex model (Eq. 2.1) by using full factorial design (Milton and Arnold 2003). Full factorial design ensured that each parameter combination was tested, one combination at a time, by translating the Rankine vortex through the grid. Full factorial design also allows best estimates of Rankine vortex parameters to be determined based on comparisons with observations of tree fall in Joplin, and identifies the most influential parameters.

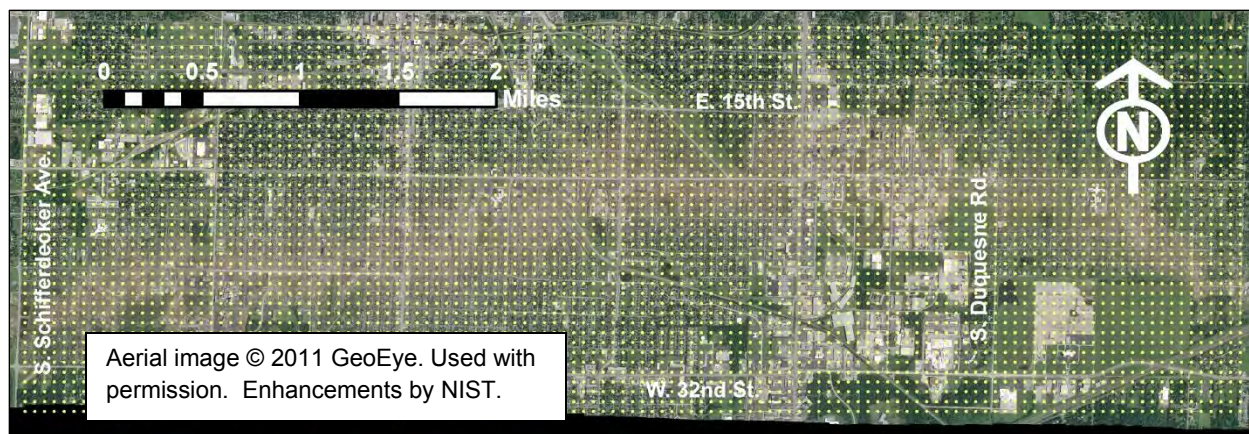

Figure 2–16. Grid system for tree fall analysis in Joplin. Each dot denotes a tree/wind–field point spaced at every 0.05 miles. The grid extends 6.2 miles west to east and 2.0 miles north to south.

Model Results—

Model outputs

For each time step, a wind speed from the Rankine model (V_{cir}) was estimated by using Eq. 2.1. Both V_{cir} and V_T were then broken up into x and y components. The x and y components from V_{cir} were then added to the x and y components from V_T to arrive at the total x and y components of wind speed. The total magnitude of the horizontal wind speed (V) was then calculated from its x and y components. The wind direction (β) was also calculated from the x and y components of wind speed.

When a wind speed (V) at a grid point exceeds V_{crit} , the tree falls in the direction of wind at that time step, denoted by the angle β . Figure 2–17 illustrates the procedure, where the contoured values represent wind speed (V), the black arrows represent the direction of tree fall (when V exceeds V_{crit}), and the red arrows illustrate the wind direction (β) at the current time step.

As each model run (parameter combination of the Rankine vortex) completes translation through the grid, outputs are generated including wind speed and direction time histories at each grid point and the wind direction associated with the tree fall (β), provided V_{crit} is reached. The numbers and locations (grid points) of fallen trees are also generated. From these outputs, the derived model outputs are produced to compare with actual observations of tree fall in Joplin. These tree fall observations are discussed in the following paragraphs.

Joplin observations

Nearly 10,000 trees were estimated to have been felled by the tornado in Joplin (Karstens et al. 2013), most of which were uprooted, as determined from aerial photos. The large number of trees located throughout Joplin made it attractive to estimate near–surface wind speeds using the Rankine vortex model and associated tree fall based on the methodology described in the previous section.

Figure 2–17. Grid overlaid with Rankine vortex model results. Red arrows represent current wind direction, black arrows represent direction of tree fall, and contouring illustrates wind speed field.

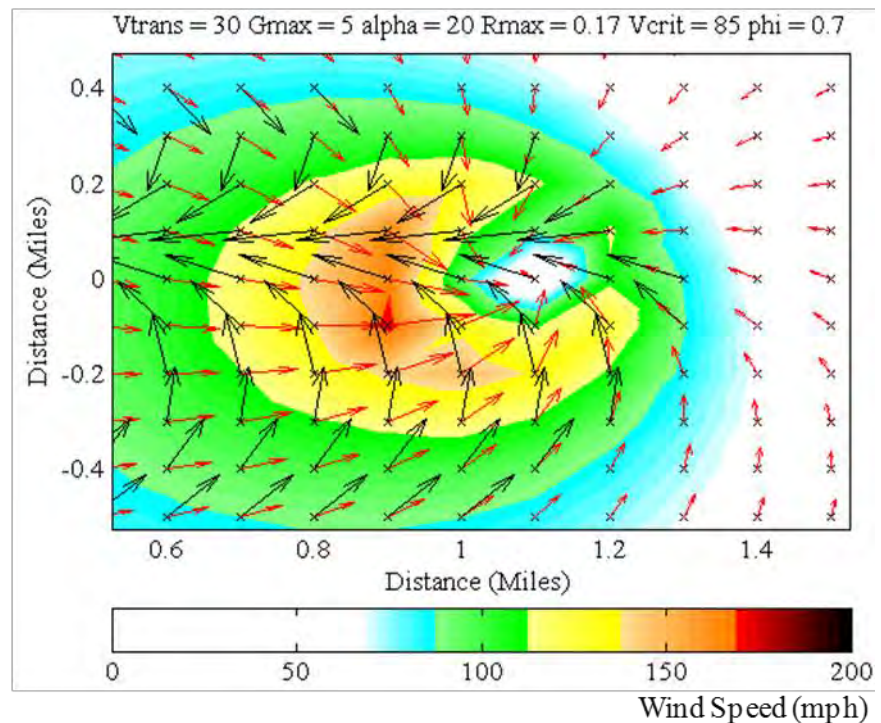

The directions of tree fall for approximately 5,000 felled trees throughout the tornado path were drawn digitally using post-storm aerial photos. Figure 2–18 shows the tree fall patterns observed between 20th and 32nd streets just east of Schifferdecker Avenue. A non-exhaustive list of the types of trees that fell in the Joplin tornado, as determined by field surveys, aerial photos, and interview transcripts, is as follows: American and Chinese elm, American sycamore, yellow poplar, shagbark hickory, white oak, and Bradford pear.

Based on the observed tree fall in Joplin, three model output parameters were developed and compared to the observations in Joplin:

- **Damage width (DW):** This parameter refers to the width of the swath of felled trees (north-south alignment). It was estimated by locating the furthest extent in either direction where it appeared that most (i.e., more than 50 percent) of trees had fallen. This spatial dimension was measured at a minimum of 0.02-mile increments.
- **Damage ratio (DR):** This is the ratio of DW on either side (i.e., south and north) of the "convergence line" (shown in Fig. 2–19). The convergence line was estimated to be the location where the patterns of tree fall on either side of the tornado center converge.
- **Tree fall directions ($\beta_1 \dots \beta_n$):** The tree fall directions were estimated from calculating the angle associated with the direction of tree fall as drawn in ArcGIS. If possible, the fall direction of three to four trees in close proximity (0.01 miles, or 30 m) were averaged to calculate a reasonable estimate of β . For this work, angles of 90 degrees (tree fallen westward) and 180 degrees (tree fallen northward) were used for comparison.



Figure 2–18. Observed tree fall pattern between 20th and 32nd streets just east of Schifferdecker Ave. Area is approximately 0.5 miles west to east by 1.0 miles north to south.

The parameters DW , DR , β were estimated at 10 locations in Joplin from aerial photographs using the methods described above, and presented in Table 2–4. For β , the table shows locations (in the y -direction) that correspond to the 90- and 180-degree tree fall directions. The values in the “ β ” columns are distances in miles either south (–) or north (+) (i.e., in the y -direction) of the convergence line. An example comparison at one location between model outputs and observed values for DW , DR , β is shown in Fig. 2–19.

Table 2–4. Observed Joplin tree fall metrics.

Tornado Center Location (X)	Damage Width (DW) (in miles)	Damage Ratio (DR)	Locations of Tree Fall Directions (miles S (–) or N (+) of convergence line)	
			β (90 degrees)	β (180 degrees)
0.69	0.55	2	–0.02	–0.3
0.88	0.6	2	–0.04	–0.38
1.01	0.7	2	–0.04	–0.42
1.22	0.75	2	–0.02	–0.32
2.09	0.9	2	0	–0.28
3.14	1	2.3	–0.06	–0.46
3.69	0.85	2.3	0	–0.38
6.01	1	2	+0.04	–0.36
6.47	1	2	+0.12	–0.18
6.77	1	2	+0.16	–0.18

Model comparisons to Joplin observations

Using full factorial design, main– and interaction–effects plots (Box et al. 2005) were created by NIST. Main and interaction effects illustrate the effects of varying the input parameters of the Rankine vortex model (in this case RMW , α , etc.) on the final output parameters that can then be compared to the observations in Joplin (DR , DW , β). Additional details on the comparison between the Rankine vortex model and observations used in selection of the final model parameters are provided in Appendix D. These details include a general explanation and interpretation of main and interaction effects plots. Based on the generation of Rankine vortex input parameter combinations by the use of full factorial design, the variability in output parameters (DR , DW , β) is discussed. An example of the use of main and interaction effects plots to select of “best matches” (i.e., narrowed parameter ranges) of Rankine vortex input parameters (RMW , α , etc.) to observed tree fall metrics (Table 2–4) throughout Joplin is also discussed. The process of selecting “best matches” is illustrated for a specific set of north–south grid points in Joplin. These “best matches” for locations throughout Joplin are listed in Appendix D, Table D–1.

The “best matches” of the Rankine vortex input parameters were used to calculate wind speed and wind direction time histories at each grid point in Joplin based on Eq. 2.1. A specific grid point (#1175, X = 2.1 and Y = 0.45) was chosen to illustrate the variation in wind speed and wind direction based on Rankine vortex parameter combinations created in the factorial design. The graphs in Fig. 2–20 show the ranges and “best estimate” (i.e. average value of best matches) of wind speed and direction. Note the differences in time and magnitude among the maximum wind speeds in the three time series. These are due to the translational speed (V_T) of the tornado. The translational speed of the tornado is also included in the final estimation of wind speed (V), and contributes heavily to the uncertainty of maximum wind speed and maximum duration of a given wind speed as will be discussed later. Wind direction does not have as much uncertainty as wind speed for this specific grid point. Due to the many directional changes (changes in damage path) within the track of the Joplin tornado, however (Fig. 2–21), it was difficult to pinpoint an exact location when the tornado changed direction. When interpreting the final wind speed and wind direction estimates from the wind field model, uncertainty should include values from one grid point (264 ft, 80 m) away in any direction.

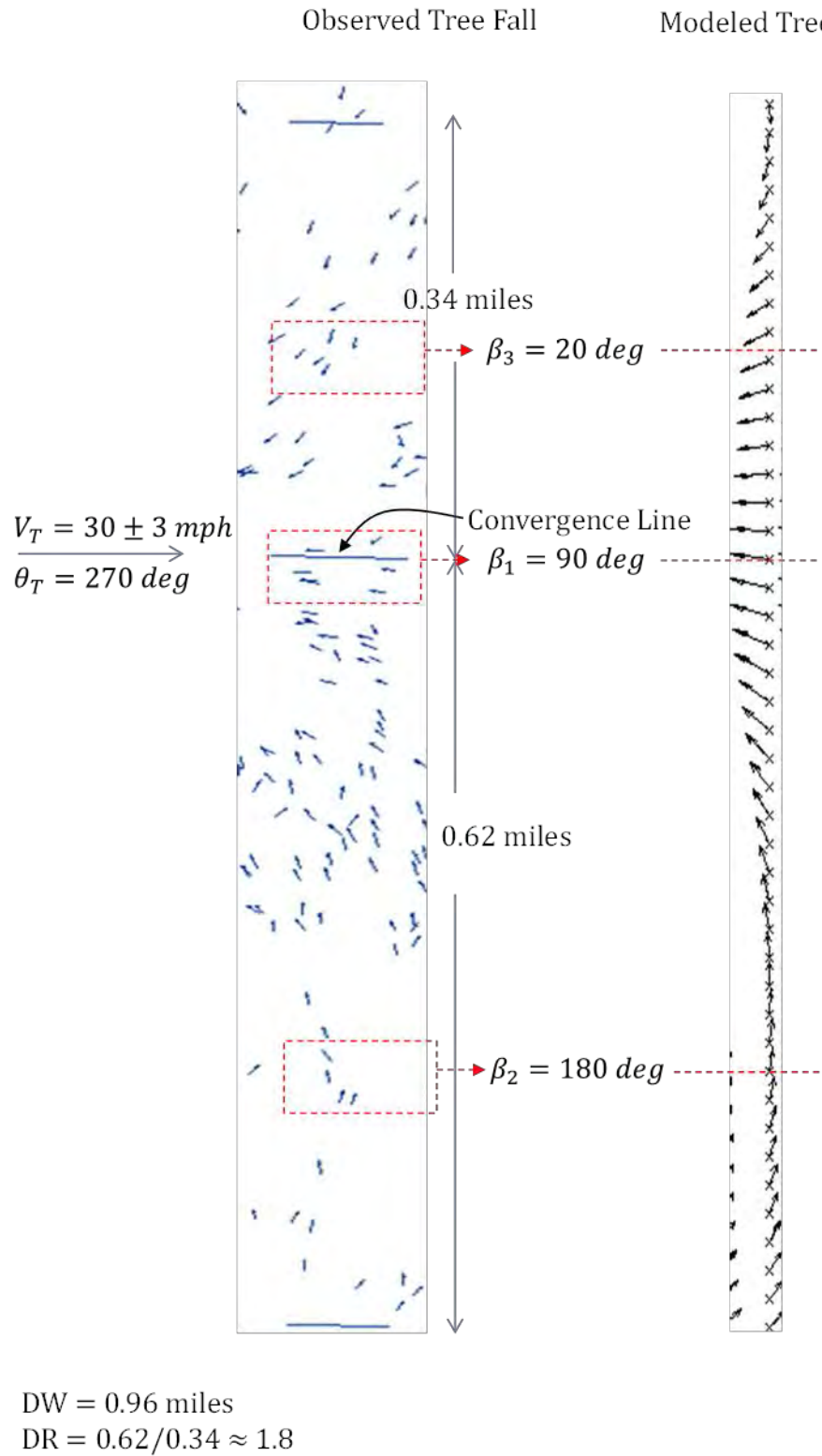

Figure 2–19. Example of procedure for comparing observed tree fall to modeled tree fall. Output parameters are also listed.

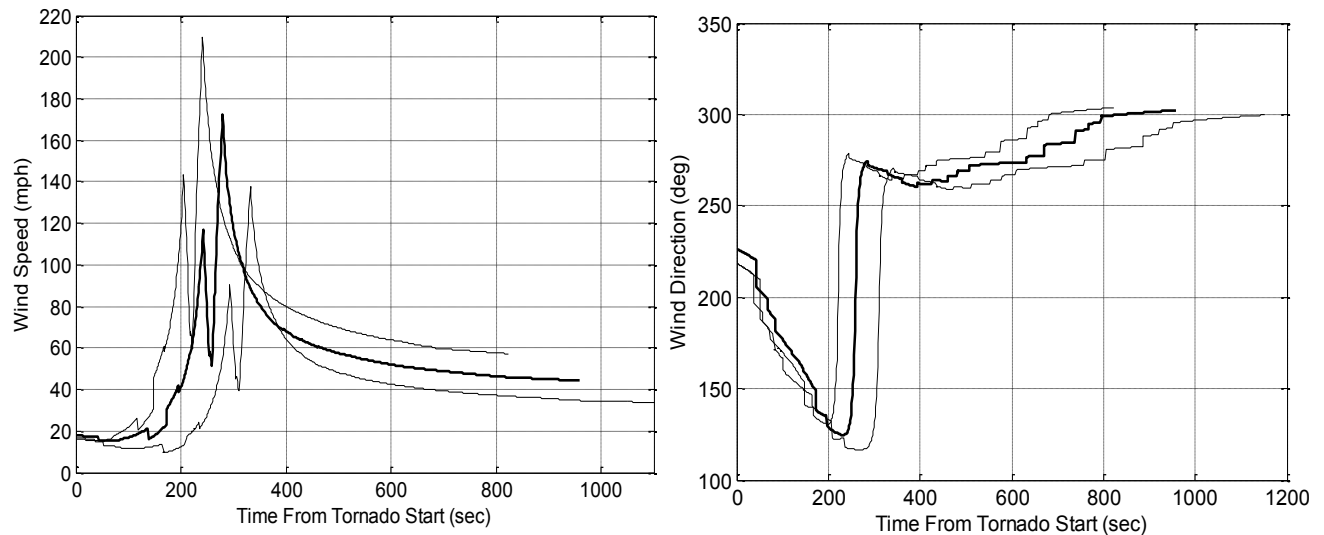

Figure 2–20. Ranges and best estimate of wind speed (left) and associated wind direction (right) for X = 2781933 ft, Y = 326052 ft; Grid Point #1175. Best estimates are the bold traces on each plot.

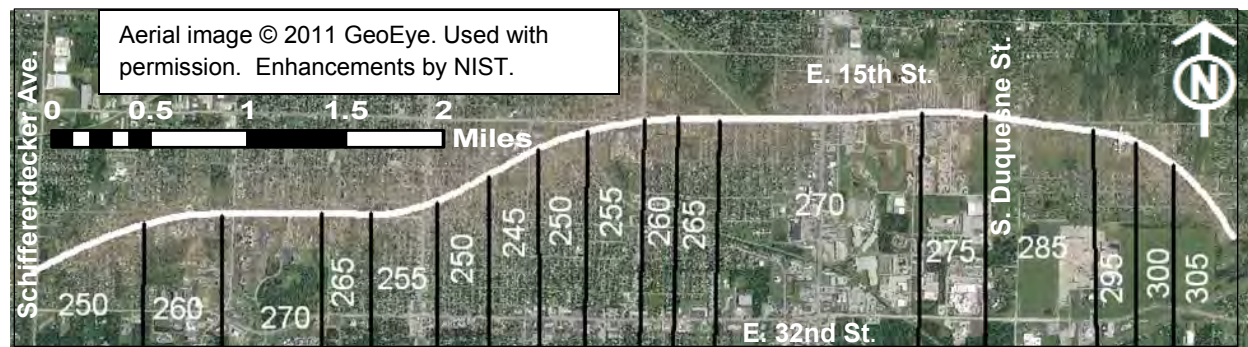

Figure 2–21. Translation direction (θ_T) changes in the Joplin tornado. Numbers are approximate directions in degrees. White line indicates estimated center of tornado path. The area in the figure is approximately 6.2 miles west to east and 2.0 miles north to south.

Wind Field Characterization—

Overall

Based on the examples above, the range and best estimate of maximum wind speed values, and associated wind direction values, as illustrated in Fig. 2–20, were recorded for each grid point. For the chosen reference grid point (#1175) the range of maximum wind speed was 135 mph to 210 mph, while the best estimated value was 175 mph. For this grid point therefore, the range of wind speeds on either side of the best estimate was up to 25 percent of the best estimated maximum wind speed. The uncertainties in maximum wind speed are discussed later in this chapter.

Figure 2–22 provides a closer examination of Fig. 2–20 using best estimated wind speeds. This location was within the *RMW* (likely in the corner flow region or Region III as illustrated from a general case in Fig. 2–9). According to the model, this grid point was near the possible “eye” of the tornado. As the

tornado approached wind speeds increased to approximately 115 mph to 120 mph then dropped rapidly to speeds below 60 mph when the tornado center was near, and increased on the back side of the tornado to a maximum of approximately 175 mph. Between the first and second peaks, the wind direction shifted nearly 180 degrees in approximately 30 seconds to 40 seconds. Time histories for every grid point with best estimated wind speed and direction values (and more information on the wind field modeling process) will be available through the NIST Disaster and Failure Studies Event Data Repository web site (http://www.nist.gov/el/disasterstudies/repository_home.cfm) when the Joplin Tornado Repository is completed. Best estimated time histories nearest to structures surveyed by NIST can be found in Appendix E. These time histories were also used to study both structural (Chapter 3) and human (Chapter 4) responses to the Joplin tornado.

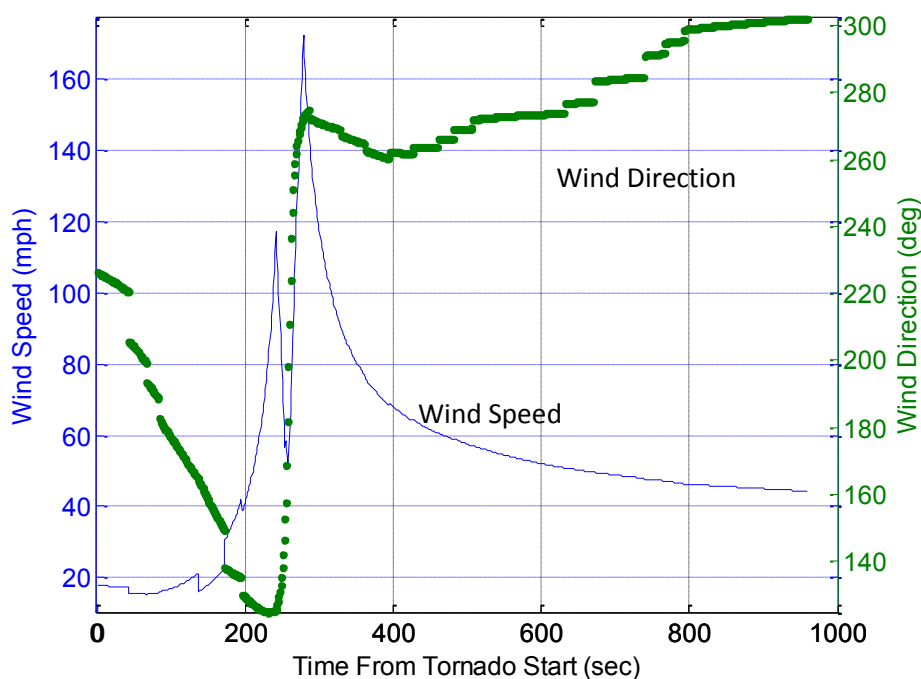

Figure 2–22. Example of a modeled best estimate of tornado wind speed and direction time history associated with the Joplin tornado (X = 2.1, Y = 0.45).

The best estimated maximum wind speed (e.g., 175 mph for X = 2.1, Y = 0.45) at each grid point was rounded to the nearest 5 mph, loaded into ArcGIS, and overlaid with post-storm aerial photos. The grid points, as mentioned earlier, correspond with latitude and longitude coordinates in Joplin.

From the maximum wind speed information, two shapefiles were created in ArcGIS. The first shapefile shows the grid points in the wind field estimation colored by their best estimated maximum wind speed value. This wind field estimation is illustrated in Fig. 2–23. The coloration is based on wind speed ranges outlined in the EF Scale. The second shapefile was created by drawing polygons around areas that were within the wind speed ranges prescribed by the EF Scale. These polygons are shown in Fig. 2–24.

Important Note: The methodology for and generation of the wind field from tree fall as discussed above was completely independent of the EF Scale with the exception of minor input for V_{crit} . However, the wind speed ranges associated with different EF numbers (e.g., EF-0, EF-1, . . . EF-5) in the EF Scale are helpful for comparing the estimated wind field in the Joplin tornado to other tornadoes in a historical context as well as to other tornado wind field models. The EF Scale is a damage-based scale only. For example, an estimated wind speed of 175 mph from tree fall should not be interpreted as an EF-4 wind speed as EF-4 wind speed estimates are derived from structural damage only. The estimated 175 mph wind speed should be interpreted as a wind speed associated with the range of EF-4 wind speeds in the EF Scale.

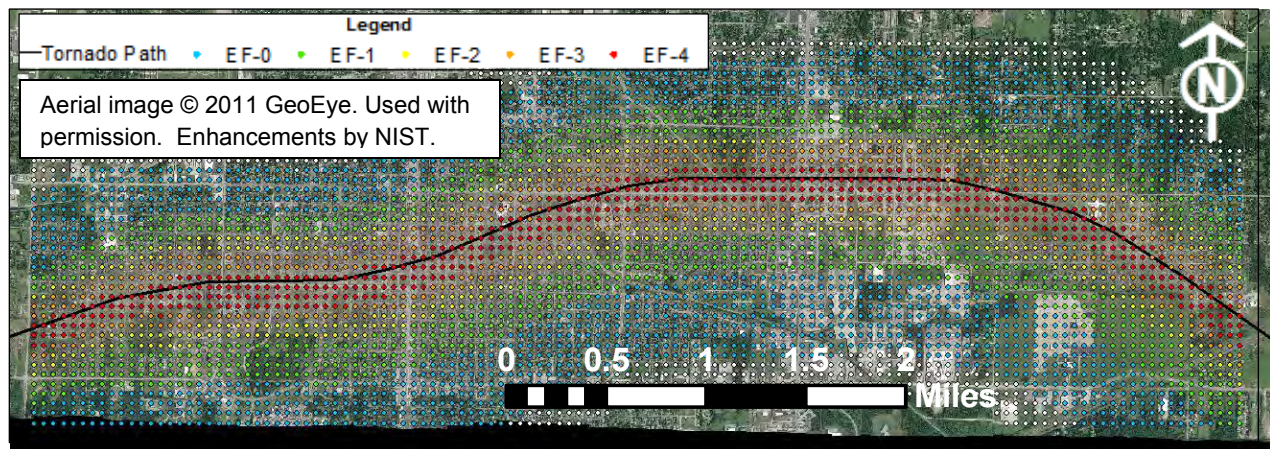

Figure 2–23. Estimated maximum wind speed grid points from tornado wind field model grid points grouped by EF Scale. The solid black line represents the estimated tornado center. The area in the figure is approximately 6.2 miles west to east and 2.0 miles north to south.

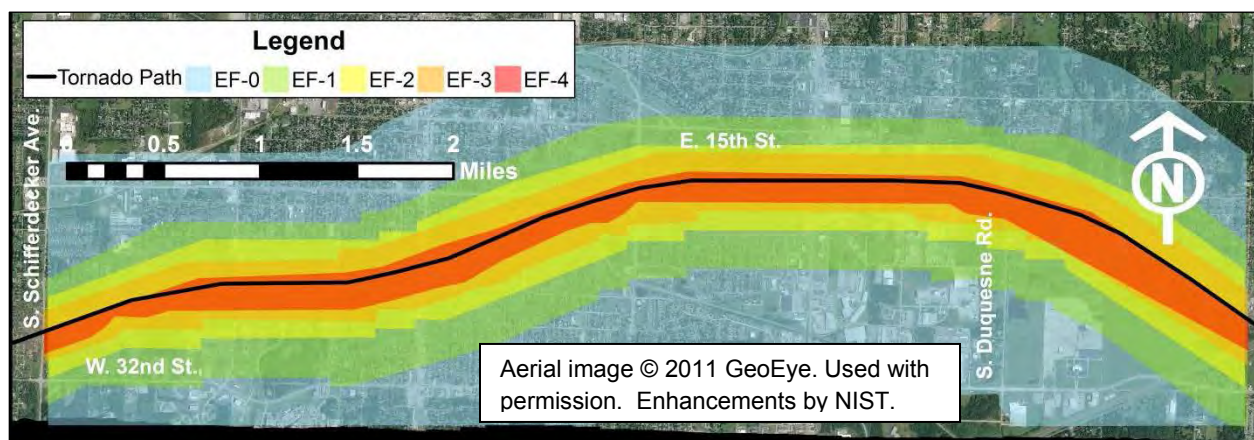
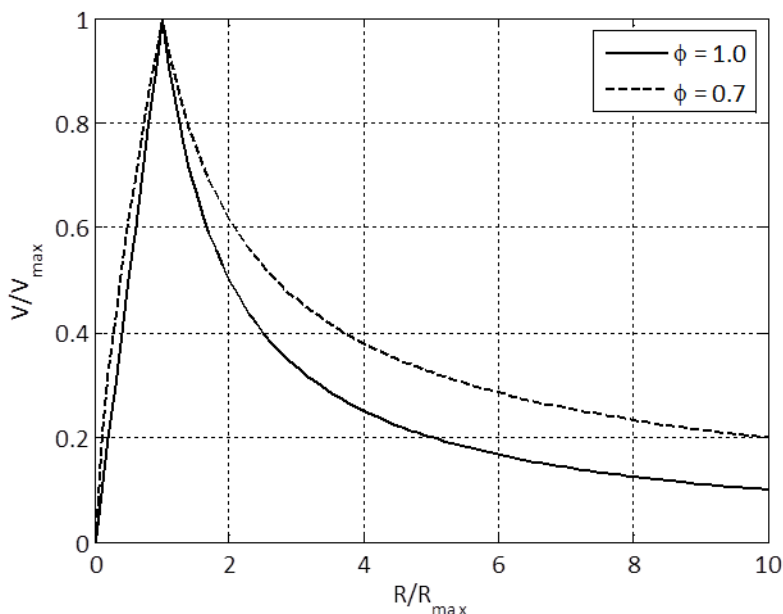

Figure 2–24. Estimated maximum wind speed polygons from tornado wind field model grouped by EF Scale. The solid black line represents the estimated tornado center. The area in the figure is approximately 6.2 miles west to east and 2.0 miles north to south.

Duration of high wind speeds

Low ϕ values ($\phi = 0.6$ to 0.7), along with a relatively slow translation speed ($V_T = 25$ mph to 35 mph) and the high radial component to the flow ($\alpha = 15$ degrees to 25 degrees) suggest that wind speeds remained above a certain level for a relatively long time and over a large area in the Joplin tornado, a notion that is expanded upon in the next paragraph. For example, the Rankine model with a ϕ value of 0.7 predicts that once the wind speed reaches its peak value, it doesn't drop off as fast as for a ϕ value of 1.0 , i.e., high wind speeds extend farther out from the center of the tornado (Figure 2–25).

Figure 2–25. Illustration of differences in Rankine vortex model given ϕ parameter.



The duration of damaging winds can play a significant role in overall damage states (Kopp and Morrison 2011). Figure 2–26 shows the estimated amount of time that the modeled wind speeds were at an EF–2 level or above (≥ 49.2 m/s or 110 mph). Each time step that was at or above the EF–2 level was summed to estimate the duration. The best estimated longest duration of EF–2 or greater wind speeds in the Joplin tornado was approximately 67 seconds, with a range of 33 seconds to 107 seconds considering the uncertainty in the input parameter values used in the wind field model. The longest duration of damaging

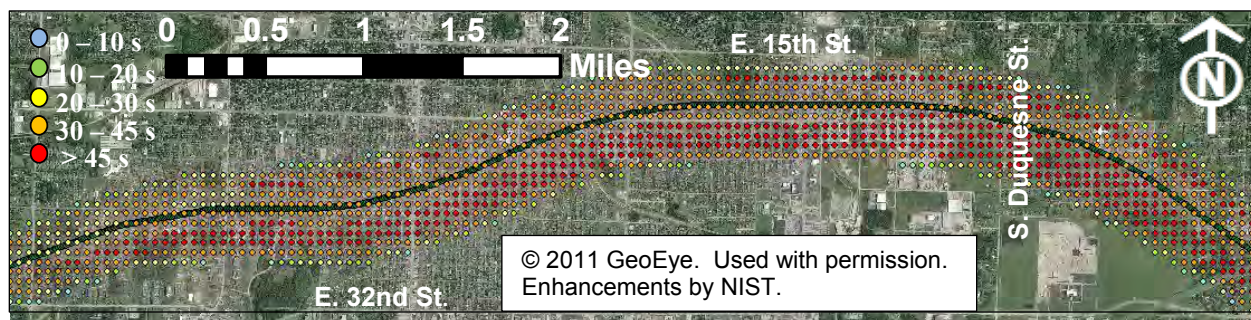

Figure 2–26. Best estimate of duration of wind speeds greater than or equal to EF–2 (≥ 110 mph). Green line shows estimated tornado center. The area in the figure is approximately 6.2 miles west to east and 2.0 miles north to south.

wind speeds was mainly south of the estimated tornado center shown in Fig. 2–26. The majority of areas that experienced any EF–2 or greater wind speeds encountered over 30 seconds of such winds due to the structure of the wind field.

With regard to spatial extent, the total modeled area affected by wind speeds EF–0 or higher (≥ 65 mph (29.1 m/s)) during the Joplin tornado was estimated to be 10.5 square miles. Table 2–5 presents information about the areas affected by each of the EF wind speed ranges. The table also provides the percentages of affected areas expected under each EF level in hypothetical EF–4 and EF–5 tornadoes in probabilistic assessments of tornado hazards using historical data (NRC 2007). The Joplin tornado had larger areas subjected to the highest wind speeds compared to the theoretical tornadoes in NRC (2007). Aspects of the spatial dimensions of tornadoes and associated damage compared to the Joplin tornado are discussed further in Sec. 2.4.

Table 2–5. Estimated areas affected by wind speeds falling within the EF wind–speed ranges, within Joplin grid system and in theoretical EF–4 and EF–5 tornadoes.

EF Number	Area Affected ^a (sq. mi.)	Percent of Area Affected ^b	Area with Maximum Wind Speed ^c (sq. mi.)	Percent of Area with Maximum Wind Speed ^d	Percent of Theoretical EF–4 Area with Maximum Wind Speed ^e	Percent of Theoretical EF–5 Area With Maximum Wind Speed ^f
0	10.5	100	5.2	49	54.3	53.8
1	5.3	51	2.2	20	23.8	22.3
2	3.1	30	0.9	9	13.1	11.9
3	2.2	21	1.1	11	5.6	7.0
4	1.1	11	1.1	11	3.2	3.3
5	0.0	0	0.0	0	0.0	1.7

- Total area within Joplin grid system that was affected by winds falling within the wind–speed range of the specified EF number or a higher EF number.
- Percentage of the total area within Joplin grid system that was affected by winds falling within the wind–speed range of the specified EF number or a higher EF number.
- Total area within Joplin grid system where the maximum wind speed experienced during the Joplin tornado fell within the range of the specified EF number.
- Percentage of the total area within Joplin grid system where the maximum wind speed fell within the range of the specified EF number.
- Percentage of the total area affected by a theoretical EF–4 tornado (NRC 2007) where the maximum wind speed fell within the range of the specified EF number.
- Percentage of the total area affected by a theoretical EF–5 tornado (NRC 2007) where the maximum wind speed fell within the range of the specified EF number.

Maximum wind speed (\hat{V})

The tree fall model indicated that the “expected” or best estimated maximum wind speed anywhere in the tornado was approximately 175 mph, with generally ± 35 mph uncertainty ranges in these areas. Given this range of information, the maximum wind speeds in the Joplin tornado based on the tornado wind field model ranged from 135 mph to 210 mph. For areas that were within the *RMW* on some model runs and outside of the *RMW* on others (e.g., locations between 0.14 miles and 0.18 miles from the tornado

center), wind speed ranges were as high as ± 45 mph. As stated earlier, a great deal of the total model uncertainty in wind speed is due to the range of the translation speed (V_T). In the factorial analysis, there are three distinct maximum wind speed ranges that are produced. These ranges are based on three different values of V_T . These ranges are illustrated in Fig. 2–27 for $X = 2.1$, $Y = 0.45$. If V_T was kept fixed at the average value of 30 mph, the estimated range produced for areas in Joplin that experienced the highest wind speeds was approximately 160 mph to 180 mph. In other words, up to 80 percent of the model uncertainty is due to uncertainty in V_T . The remaining uncertainty is in the G_{max} parameter, the only other variable used in the calculation of \hat{V} (Eqn. 2.2). This estimate does not include the model assumptions and limitations mentioned earlier in this section. The ranges in Fig. 2–27 were developed using range values for all six input parameters as well as the best estimated parameter value for a total of 729 (3^6) factorial runs to show the differences in V using different values of V_T . The coefficient of variation (COV) for this particular grid point considering all values of V_T was approximately 0.14. Using only the ranges values with with 64 (2^6) factorial runs, the COV was approximately 0.17. These values of the COV were consistent for all grid points analyzed. It should be noted that the uniform distributions of maximum wind speed are due to the fact that the values of the input parameters (V_T and G_{max} in this case) in the factorial design were equally likely as a result of the factorial design (uniform distribution). No specific distribution was given to the input parameters. The nine (3^2) different combinations of maximum wind speed, using the range values of V_T and G_{max} are shown as red dots in Fig. 2–27.

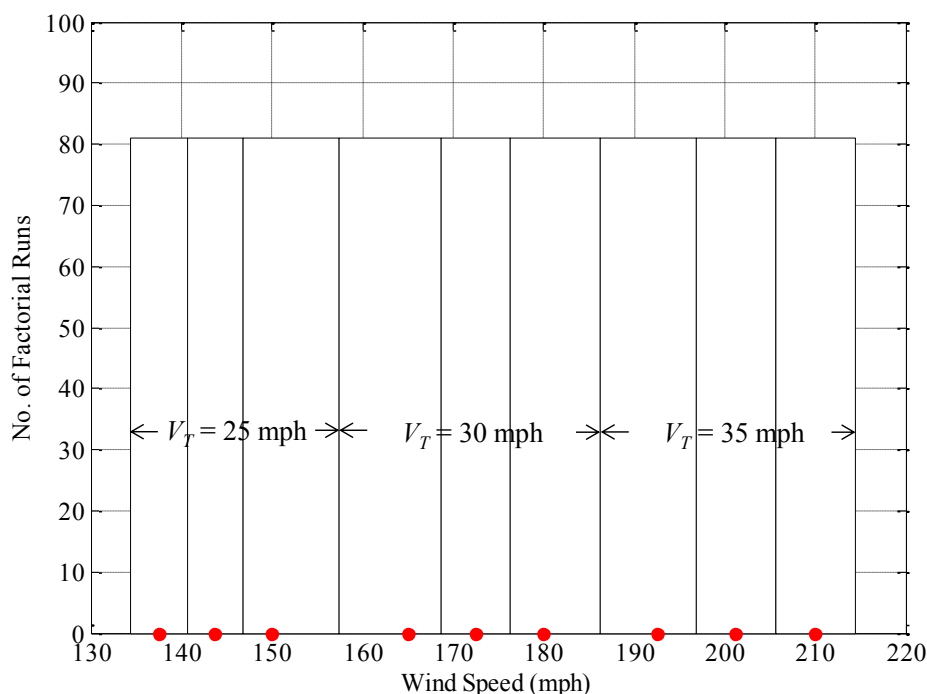

Figure 2–27. Three distinct ranges of maximum wind speed based on different values of translational speed (V_T) for Grid Point #1175 ($X = 2.1$, $Y = 0.45$). Red dots illustrate the combinations of V using the range values of V_T and G_{max} .

Model Comparisons with Other Estimates—

It should be noted that although comparisons are made here between wind speeds generated from the wind field–tree fall model and other tornado wind speed estimations both in Joplin and elsewhere, the Joplin tornado was a rare event in terms of the destruction and loss it caused. In other words, the knowledge base on events such as Joplin is lacking, making comparisons difficult and acknowledging our understanding is still limited.

Comparisons with maximum wind speed using EF Scale

NIST evaluation using the EF Scale for both structures surveyed on the ground and residential structures surveyed from aerial photos (see Sec. 2.3.4) yielded similar estimates of maximum wind speed, especially the lower half of the maximum wind speed range. The estimated maximum wind speed based on damage observed among NIST–surveyed structures was 150 mph \pm 15 mph (135 mph to 165 mph) and among residential structures was 175 mph. The Springfield NWS office based its estimated maximum wind speed of 200+ mph (EF–5) in part on information not contained in the EF Scale such as manhole covers and tractor trailers.⁵¹ Using tree fall analysis, Karstens et al. (2013) estimated that the maximum wind speed in the Joplin tornado exceeded 230 mph, while Roueche and Prevatt (2013) estimated maximum wind speeds to be approximately 175 mph to 180 mph using EF–Scale wind speed estimates of residential damage fit to a Rankine vortex model. The maximum wind speed estimates explicitly using the EF–scale were in general closer to those of the tornado wind field model used in the study as compared to other estimation methods. The relatively large difference in maximum wind speed estimates from the other tree fall estimation is likely due to the different methodologies employed (e.g., using non–uniform distributions for critical tree fall wind speed in Karstens et al., 2013).

Comparisons with EF–derived wind speeds at specific locations

Best estimated maximum wind speeds at specific locations in Joplin derived from the wind field model were compared to the estimated values of maximum wind speed generated using the EF Scale for selected NIST–surveyed structures, as shown in Table 2–6. The table shows the best estimated range of maximum wind speeds at each site given that all the structures have significant dimensions. For example, on the north side of the Walmart store, wind speeds were best estimated to be 110 mph, while maximum wind speeds on the south side were estimated to be 160 mph. Overall, the estimates of wind speeds by tree fall were comparable to those estimated by using the EF Scale for NIST–surveyed structures. Time histories for the structures listed in Table 2–6 can be found in Appendix E.

Comparisons with historical and contemporaneous observations

Observed tree fall metrics were compared with observations in other tornado events as well as the Joplin tornado.

- Damage width (*DW*): The *DW* of tree fall in the Joplin area was up to 1.0 mile (about 1,600 m) in some cases, and was generally above 0.9 miles (about 1,450 m) for most of the Joplin tornado path. This width is consistent with the estimate of tornado width (extent of damage) for the Joplin tornado determined by the NWS.⁵² If using the definition of tornado width as being the distance from EF–0 contours perpendicular to the tornado path, the wind field–tree fall model produced a width of up to 1.8 miles.

⁵¹ NIST Interview 205, May 2011.

⁵² NWS (www.crh.noaa.gov/sgf/?n=event_2011may22_survey).

Table 2–6. NIST best estimate of maximum wind speeds for NIST–surveyed structures using tornado wind field model and EF Scale.

NIST–Surveyed Structure	Range of Model–Estimated Wind Speeds over the Entire Facility (mph)	EF–Scale Point Estimate of Wind Speed (mph)
Walmart	110 (N) – 160 (S)	140 ± 15
Home Depot	135 (S) – 175 (N)	150 ± 15
Franklin Technology Center	135 (N) – 160 (S)	150 ± 15
Joplin High School	130 (N) – 175 (S)	140 ± 15
SJRMC (Main Buildings)	135 (S) – 175 (N)	140 ± 15
Joplin East Middle School	135 (N) – 175 (S)	140 ± 15

Key: SJRMC, St. John’s Regional Medical Center; N, north side; S, south side.

- Damage ratio (DR): The DR was about 2.0 to 2.3 in most areas of Joplin. Similar DR values were estimated when damage resulting from the Spencer, South Dakota, tornado was surveyed (Wurman and Alexander 2005, Part II). These DR values suggest small alpha values (more radial inflow) as described previously and discussed below.

Comparisons using Rankine vortex (input) parameters

The estimated final ranges of the Rankine vortex (input) parameters were compared, if applicable, to other tornado events as well as the Joplin tornado.

- Critical wind speed (V_{crit}): Average critical tree fall wind speeds that best matched observed tree fall patterns ranged from 85 mph to 95 mph.
- Radius of maximum wind (RMW): RMW values ranged from 0.07 miles (113 m, 370 ft) in the early stages of the tornado to a maximum of 0.18 miles (290 m, 950 ft). For a majority of the tornado path, the tornado maintained a best estimated RMW of 0.16 miles (260 m, 845 ft). These RMW values are within the limits observed by radar estimation in other violent tornadoes (Wurman et al. 2007) and the average value of approximately 260 m is similar to that estimated by Karstens et al. (2013) for the Joplin tornado (300 m).
- Alpha (α): There was a significant radial component (V_r) ($\alpha = 15$ degrees to 25 degrees) at the near surface (i.e., < 20 m). Although no published radar measurements at less than 20 m are noted, Kosiba and Wurman (2010) showed that the radial component of the Spencer, South Dakota, tornado increased nearer to the ground. The damage ratio (DR) parameter, as mentioned earlier, has a strong relationship with the α parameter. Karstens et al. (2013) also estimated highly radial flow in the Joplin tornado on the order of 2:1 when compared to tangential velocity. This ratio implies an alpha value of approximately 26 degrees.
- Rotation–translation ratio (G_{max}): The G_{max} parameter was estimated to range from 4.5 to 5.0. These values are close to those found in observed tornado tree fall studies that estimated G_{max} (Beck and Dotzek 2010; Bech et al. 2009).

- Phi (ϕ): The analysis suggested that ϕ ranged from 0.6 to 0.7, instead of being 1.0 as suggested by conservation of angular momentum (see Sec. 2.3.2). These values of ϕ compare well with actual vortex phenomena in other tornado events, as mentioned earlier in this section.

2.4 DESCRIPTION OF THE TORNADO HAZARD IN THE UNITED STATES

2.4.1 Objective

The objective of Sec. 2.4 is to understand the U.S. tornado hazard at the local, regional, and national levels and to place the Joplin tornado in context of this hazard. In pursuit of understanding the tornado hazard at the local, regional and national level, Section 2.4.2 briefly discusses tornado climatology. This section includes a brief literature review and an introduction to the official NOAA tornado database. The NOAA database will be used to assess the tornado hazard. Section 2.4.2 also discusses human and economic losses and methods of determining a probability-based tornado hazard in the United States for local, regional and national levels including Joplin using the NOAA database. Section 2.4.3 briefly highlights how urbanization is affecting considerations of the tornado hazard.

2.4.2 Tornado Climatology

A number of studies regarding U.S. tornado climatology are available in the literature (e.g., NRC 2007, DOE 2000, Brooks et al. 2003, Dixon et al. 2011). These references all show that the frequency of tornadoes is greater east of the Rocky Mountains and west of the Appalachian Mountains, with the highest frequencies being in the Great Plains and the Southeast United States. Two references (NRC 2007; DOE 2000) provide detailed probabilistic analyses for determining the tornado hazard in the United States for engineering purposes, which is discussed further in Sec. 2.4.2.3. Two other references (Brooks et al. 2003a; Dixon et al. 2011) discuss tornado climatology in a more meteorology-oriented manner.

2.4.2.1 NOAA Tornado Database

To provide tornado climatologies for the current study, data covering the period 1950–2011 and containing information on U.S. tornadoes were available from the NWS SPC (www.spc.noaa.gov/wcm/). These data included, among other elements, the time and date of the tornado touchdown; resulting numbers of injuries and fatalities; estimates of property and crop losses; the starting and ending latitude and longitude coordinates; and the length and width of the tornado path.

Note: Tornadoes rated under the old F Scale were assumed to be representative of the same EF-Scale value for this report. For example, an F-1 rated tornado corresponds to an EF-1 rated tornado for the purposes of this analysis.

There are some inaccuracies in the NOAA database. A number of these inaccuracies stem from non-meteorological reporting changes in the database (Verbout et al., 2006). These changes include a reporting increase of EF-0 tornadoes due to increased storm spotters and public awareness, the NWS radar system and the improvement of collection efforts for warning verification. Other issues affecting the entire database include difficulties in reporting exact locations and times by observers, and rating tornadoes with intensity estimated on the basis of observed damage as well as population increases (Verbout et al., 2006).

2.4.2.2 Tornado-Induced Losses

Human Losses Due to U.S. Tornadoes—

A small number of tornadoes, mostly at the high end of the EF Scale, have caused a majority of the fatalities. This is shown in Fig. 2–28, which plots the number of fatalities per tornado by EF-Scale rating as well as total number of fatalities by EF rating (in red). There is an approximately log-linear increase in fatalities per tornado versus the EF Scale. Approximately 64 percent of all fatalities from tornadoes in the United States (1950–2011) have been due to EF-4 or greater tornadoes. A total of 86 percent of fatalities have been due to EF-3 or greater tornadoes and 96 percent due to EF-2 or greater tornadoes. On average, an EF-5 rated tornado causes approximately 20 fatalities. The EF-5 rated Joplin tornado was responsible for 161 fatalities.

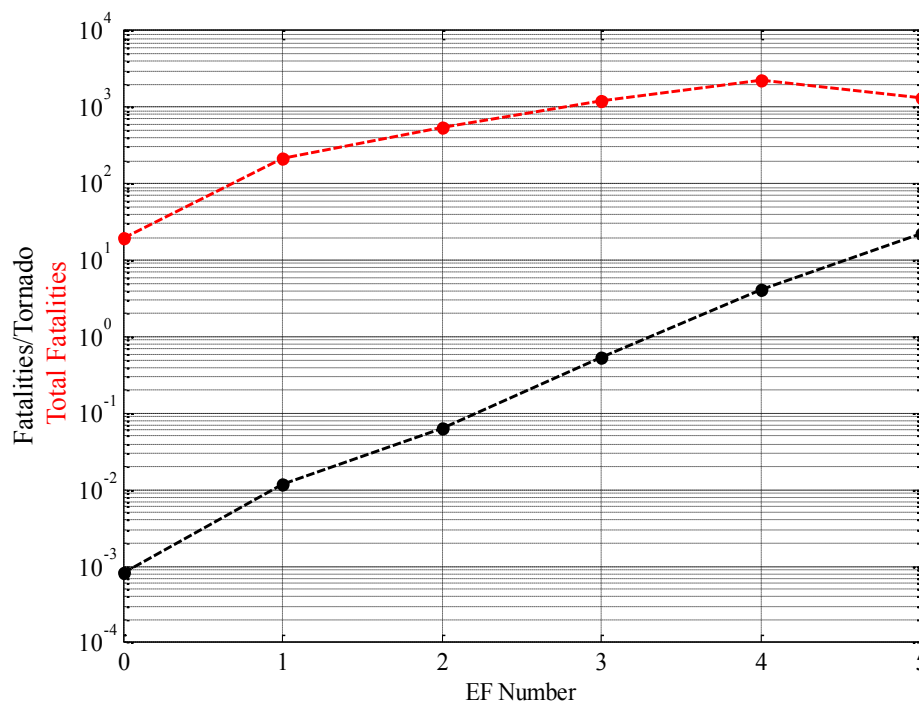

Data Source: NOAA. Analysis by NIST.

Figure 2–28. Average fatalities per tornado and total fatalities by EF number for the period of 1950–2011.

Economic Losses Due to U.S. Tornadoes—

Damage costs in the NOAA database were given in ranges (e.g., \$50,000–\$500,000) until 1996. From 1996 through 2011 specific estimated property loss amounts were provided. Shown in Fig. 2–29 is the loss per tornado and total losses (in red) by EF number. As expected, per tornado loss is much greater for stronger tornadoes, especially EF-4 and EF-5 tornadoes. For example, an EF-5 tornado, on average,

causes \$100 million in losses. The Joplin tornado was estimated to have caused losses totaling \$3 billion. As an EF-5 tornado by definition, causes substantial damage, it is expected that a smaller amount of EF-5 tornadoes can cause comparable loss to an greater amount of tornadoes with smaller EF numbers. Cumulative losses in EF-3 to EF-5 tornadoes are similar to each other and account for over two-thirds (67.5%) of all losses in tornadoes. EF-1 and EF-2 tornadoes account for approximately 30% of all losses. Figure 2-29, as with fatalities, shows somewhat of a log-linear increase in economic losses per tornado as the EF number increases

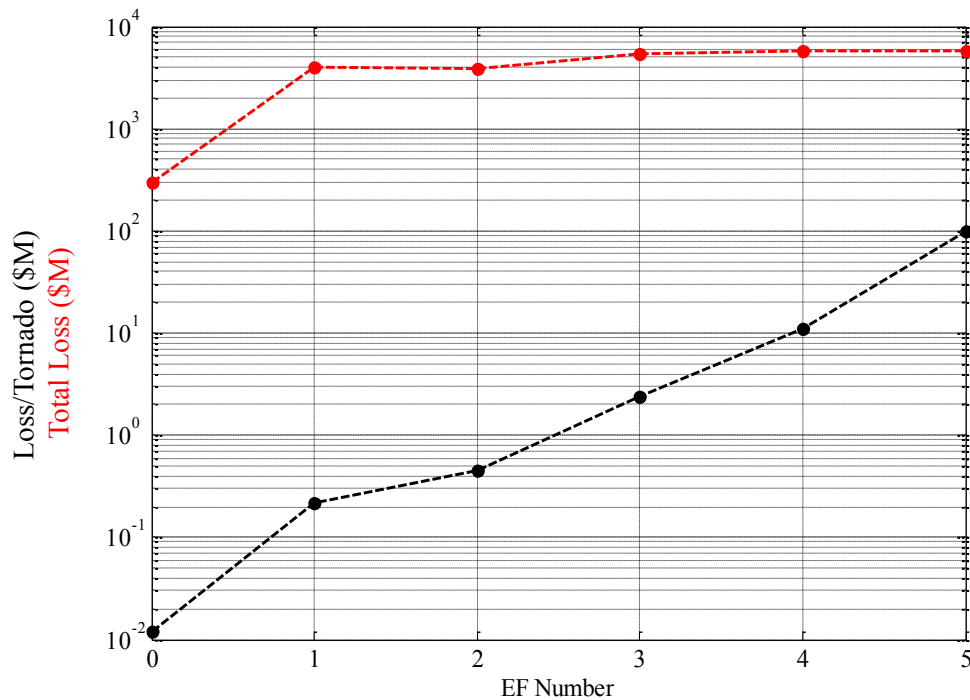

Data Source: NOAA. Analysis by NIST.

Figure 2-29. Average loss per tornado and total loss by EF number for the period of 1995–2011 (in 2011 dollars).

2.4.2.3 Tornado Hazard Analysis

In order to illustrate how the tornado hazard is currently estimated in Joplin and throughout the country, the first section discusses “point-based” (i.e. tornado-area based) probabilistic analysis. From this analysis, the tornado hazard for Joplin, the region surrounding Joplin, as well as how the tornado hazard in Joplin differs from other parts of the country can be determined. The second section describes some issues with estimating the tornado hazard using point-based analysis as observed in the Joplin tornado and suggests an alternative way (i.e., spatially based analysis) to estimate the tornado hazard for a location such as Joplin, that has many people as well as structures in a relatively concentrated area.

Point-Based Probabilistic Analysis—

The U.S. Nuclear Regulatory Commission (NRC 2007) and U.S. Department of Energy (DOE 2000) used historical tornado data from 1950–2003 and 1950–1998, respectively, to perform a probabilistic analysis of the U.S. tornado hazard. The NRC document converted F Scale wind speeds to the EF Scale using a relationship shown in the EF–Scale document (TTU 2006). In assessing the probability of tornadoes in the United States, both references employed a *conditional* probability approach in which both the probability of a tornado strike and the probability that a wind speed exceeding a certain threshold will occur, conditional on a tornado strike. To assess this probability, NRC (2007) examined the characterization of reported tornadoes throughout the United States in 1–, 2–, and 4–degree grid squares in three distinct regions. These regions, labeled as “western,” “central,” and “eastern” were distinguished to better represent the regional characteristics of reported tornadoes based on the historical database. To account for spatial variations in intensity a Rankine vortex (see Sec. 2.3.2) coupled with an empirical damage model (Reinhold and Ellingwood 1982) were used to determine across–path intensities, while only an empirical model was used to determine along–path intensities.

An illustrated example of how probabilities are typically calculated in the point-based method is provided in Fig. 2–30, which shows five tornadoes (red rectangles), with a total damage area of 50 km² occurring in a 1,000 km² “Region X” over a 50 year period. The underlying probability of occurrence of tornadoes Region X is assumed to be uniform throughout the region. Therefore, five percent (50 km²/1,000 km²) of the region has been affected by tornadoes over a 50–year period. Under the “point-based” probability approach, if 5 percent of the region is affected by tornadoes in 50 years, that yields a point probability of Strike of $P = 0.05/50 \text{ year} = 0.001/\text{year}$, or stated another way, a 1 in 1,000 chance of a strike per year. The inverse of the annual probability (1,000 years) is referred to as a mean recurrence interval (MRI), which is the average time period of tornado occurrence in this case.

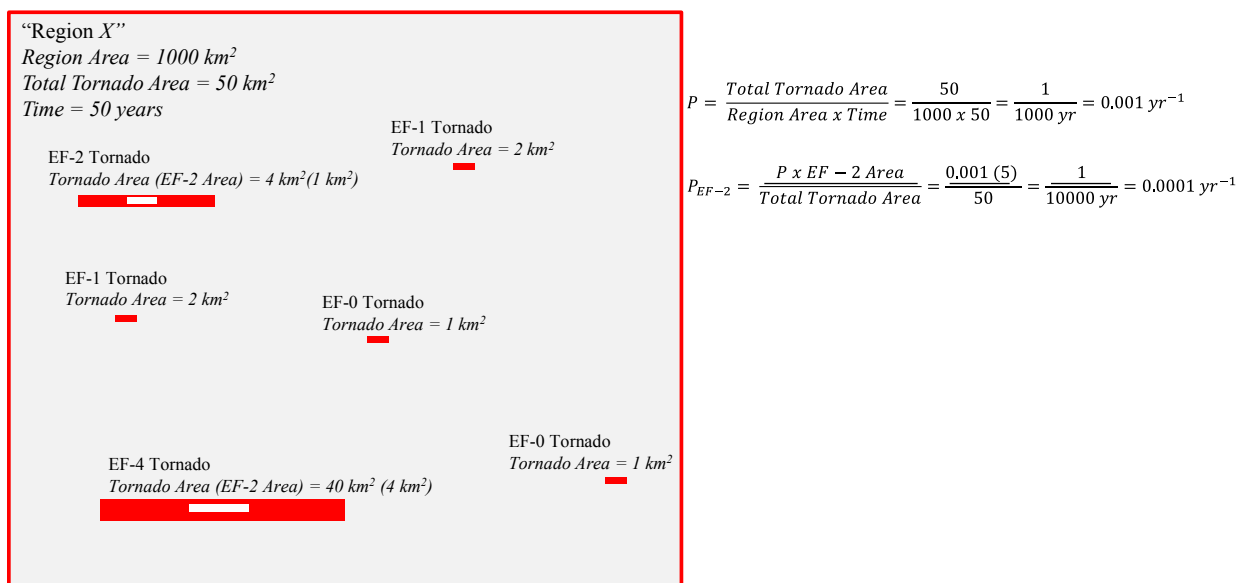

Figure 2–30. Illustration of point-based probability approach.

In that 50-year period, let's say that only 10 percent of the total area affected by tornadoes (5 km² per every 50 km²) was affected by EF-2 winds or greater (shown as white rectangles in Fig. 2-30). Therefore, the probability of being affected by EF-2 or greater winds (P_{EF-2}) decreases to by a factor of 10, on average, once every 10,000 years, for an MRI of 10,000 years. In summary, the point-based analysis only considers the overall tornado-affected area and the area affected by a certain wind speed.

Spatially Based Probabilistic Analysis—

In addition to point-based probability, both the NRC and DOE documents as well as others (Garson et al., 1976; Twisdale and Dunn, 1983) have considered tornado probabilities that account for structures that have some significant area as the probability of being struck by a tornado is greater than that based on only tornado dimensions (NRC, 2007). The motivation for spatially based analysis lies largely for estimating tornado hazard for critical infrastructure with significant area such as nuclear facilities. Point-based methods alone tend to underestimate the hazard (Twisdale and Dunn, 1983) for large structures and lifeline facilities such as long span transmission lines. In the spatially-based method, the point-based probability is then added to the probability of a tornado strike including the area of the building (i.e. union of the tornado and building area). Accounting for building dimension is analogous to saying that if a fraction of a large building is affected by a tornado, the entire building is affected. This concept is important when considering the spatially based analysis.

In addition to the previous research noting that point-based methods underestimate the hazard, there were a number of observations in the Joplin tornado that would suggest that spatially-based methods may want to be considered in estimating the tornado hazard. One observation is the difference between the probability of damage based on tornado wind field models (i.e., Rankine vortex) versus the actual probability of damaged structures in the Joplin tornado and other strong tornadoes affecting populated areas. Tornado hazard models assume that the areal extent of damage is equivalent to the areal extent of wind speed. In other words EF-3 damage, for example, is associated with an EF-3 wind speed. In NRC (2007), the areal extent of EF-3 or greater damage (wind speed) occurring provided an EF-5 tornado strikes is estimated to be about 12 percent of the total tornado path area, and about 9 percent if a tornado rated EF-4 strikes. In the 2011 Tuscaloosa tornado (rated EF-4), approximately 14 percent of the total affected area was estimated to have experienced damage associated with EF-3 or higher ratings (Prevatt et al. 2012). Damage rated F-3 or greater in the 1999 Oklahoma City F-5 tornado was estimated to be approximately 40 percent (Speheger et al. 2002). Based on the analysis in Sec. 2.3.4.1 and Table 2-2, the Joplin tornado was estimated to have approximately 28 percent EF-3 or greater damage. Table 2-7 shows the information described above.

Table 2-7. Percentage of tornado-affected areas exhibiting EF-3 or greater damage, given damage occurs and given specified tornado rating.

Tornado	Reference	EF-4 Tornado	EF-5 Tornado
Simulated	NRC (2007)	9%	12%
Tuscaloosa (2011)	Prevatt et al. (2012)	14%	–
Oklahoma City (1999)	Speheger et al. (2002)	–	40%
Joplin (2011)	NIST	–	28%

When considering damage classes (e.g., light, medium) instead of EF Scale–based damage in both the Tuscaloosa (Prevatt et al. 2012) and Joplin tornadoes, two–thirds of residential structures in Tuscaloosa were “destroyed” or had “major damage” and approximately 43 percent of all damaged structures in Joplin had similar damage states (e.g., heavy/totaled or demolished). In addition, the F–5 rated Oklahoma City tornado in 1999 damaged over 8,000 residential structures, and over one–third (2,750) of those structures were considered “destroyed” (Speheger et al. 2002).

It was estimated that approximately 30 percent of the total tornado–affected area in Joplin experienced winds that reached or exceeded speeds associated with EF–2 based on tree fall analysis, while approximately 40 percent to 50 percent of structures likely suffered at least EF–2 damage. A likely factor causing the additional damage is wind–borne debris. In Joplin, it was estimated that approximately 3 million cubic yards of debris had to be cleared due to the tornado.⁵³ As expected, in the Joplin tornado, debris was found to play a significant role in the performance of residential and commercial structures as well as critical facilities (e.g., St. John’s Regional Medical Center). In addition, a number of Joplin tornado survivors interviewed by NIST mentioned that the structures they had been in were breached by debris. Nearly all fatalities in the Joplin tornado were due to “impacts” (i.e., flying debris, collapsed structures). Further information about debris impacts on structures and loss of life is presented in Chapters 3 and 4. Breaching of structures by debris (such as by wind–borne debris that breaks through windows) has been well documented in previous tornado events and can likely increase the probability that nearby structures will sustain damage (Marshall et al. 2002). Another example relevant to using spatially–based methods is the fact that approximately 20,000 customers were without power following the Joplin tornado according to Empire Electric⁵⁴. However, there were only approximately 7,400 residences damaged due to the tornado. This discrepancy indicates that even though a home may have not been damaged by the tornado, effects from the tornado were still felt.

The information above suggests that in events that affect populated areas, and hence a large number of structures, as was the case in Joplin and the other tornado events mentioned, spatially–based rather than point–based analyses should be considered when examining the tornado hazard. Described below is an methodology using a spatially based approach.

Instead of calculating an average area affected by tornadoes, by using either path lengths and widths from the NOAA database or statistical modeling a spatially based approach would use some larger area such as a city, town, or recognized portion of a city or town (e.g., a city ward). Point probability of a strike and conditional wind speed probability are now replaced by a regional representation of tornado frequency and the area of a city for example. In other words, in a probabilistic sense, if any portion of a city or town is affected by a tornado of a given intensity, the entire city or town is affected.

A general example showing the spatially based method is shown in Fig. 2–31. As in Fig. 2–30, there are two tornadoes over a 50–year span that reach EF–2 of greater status in some portion of the tornado path (one EF–2 and one EF–4). Considering an area of a community, C , of 40 km^2 (A_c) shown in Fig. 2–31, gives an spatially–based probability (P_s) of $1/625$, or an MRI of 625 years. An MRI of 625 years means that some part of “ C ” will be affected by EF–2 or stronger wind speeds, on average, once every 625 years. In the point–based approach the MRI was estimated to be 10,000 years.

⁵³ City of Joplin (<http://www.joplinmo.org/DocumentCenter/View/1985>).

⁵⁴ NIST Interview 217, March 2013.

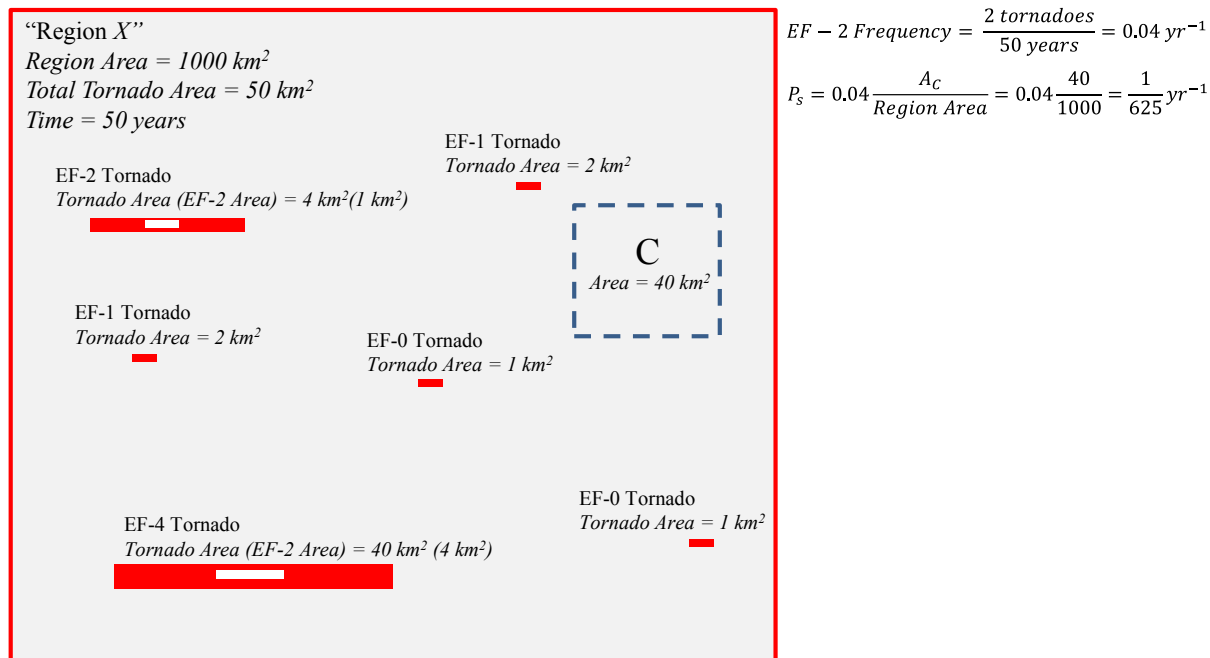

Figure 2–31. Example of spatially based approach within a given region.

Figures 2–30 and 2–31 illustrate the point–based and spatially based approaches through a simplified, hypothetical example. An application of the spatially–based method to the United States is described below.

Example of Spatially Based Probabilistic Analysis—

Figure 2–32 illustrates the spatial probability distribution of all tornadoes rated EF–2 or greater in the United States from 1950 through 2011 using the official tornado touchdown location record from NOAA. There were approximately 11,000 tornadoes rated EF–2 or higher, with a maximum axis extending from approximately Oklahoma City eastward to Birmingham, Alabama, as determined from kernel density estimation (Silverman 1986). The bandwidth used in the kernel density estimation for the spatial probability was 120 km (80 miles) as in Brooks et al. (2003). This general climatology was also reflected in both the climatological and probabilistic references discussed previously.

Over the historical record, some issues have been identified with the tornadoes categorized as F–2 or greater (Verbout et al. 2006), which are likely due to some overrating of weaker tornadoes as F–2 before 1980. Considering spatial probability distributions based on location for the periods 1950–2011 (Fig. 2–32) and 1980–2011 (not shown), there do not seem to be any significant differences in locations of EF–2 or stronger tornadoes. However, there may be a change in the frequency of these tornadoes due to the earlier overrating before 1980. The frequency of EF–2 and stronger tornadoes is important in the spatially based approach and is discussed in the next paragraph. For the purposes of this work, the frequency of 1980–2011 EF–2 and stronger tornadoes was used.

To assess the frequency of EF-2 or stronger tornadoes, grid points were spaced at 80-mile intervals. The touchdown locations of EF-2 or stronger tornadoes that occurred each year from 1980 through 2011 within an 80-mile radius (an area of slightly over 20,000 square miles) of each grid point were plotted on a map of the United States and overlaid with the spatial probability distribution of EF-2 or stronger tornado touchdown locations from Fig. 2-32 for reference. The resulting map is shown in Fig. 2-33. There is overlapping in spatial area for nearby grid points as a consequence of the grid point/radius scheme. This overlap (i.e., tornadoes counted more than once) should help to reduce some variation due to non-meteorological factors in tornado touchdown locations when comparing grid points from nearby locations.

Figure 2-33 can also be used to estimate the tornado rate per year for a location within a region. Using only EF-3 or greater tornadoes reduces the tornado rate by a factor of approximately two, but, in general, the spatial locations do not change. Both EF-4 and EF-5 tornadoes were relatively scarce during the course of the NOAA record. Therefore the number of tornadoes per year was not estimated for the spatially based approach. Maps showing tornadoes per year for EF-0 to EF-5 tornadoes (separate map for each EF number) are available in Appendix F, and can be used in the estimation of MRI in Fig. 2-34.

As a regional example, the area including Joplin, estimated from the map shown in Fig. 2-33, suggests approximately 2.0 EF-2 or stronger tornadoes per year. The four grid points nearest Joplin were estimated to contain 1.5, 1.6, 2.2, and 3.1 EF-2 or greater tornadoes per year. This means that the region surrounding Joplin (i.e., within an 80-mile radius of the city) averages approximately 2 tornadoes that reach EF-2 or stronger status every year.

Given its tornado climatology it should be no surprise that a number of tornado events affected the Joplin region before the 2011 tornado. A recorded F-2 tornado directly affected the city of Joplin on May 5, 1971. The official NOAA database lists 1 fatality, 60 injuries, and \$2.5 million in damage from this tornado.

Three tornado events that all contained at least one EF-3 or stronger tornado occurred within 25 miles of Joplin on April 3, 1956, May 4, 2003, and May 10, 2008. The 1956, F-4 tornado caused 118 injuries and likely millions of dollars in damage according to the NOAA database. The 2003 event included two F-3 tornadoes that caused 17 fatalities, 116 injuries, and over \$95 million in damage. The 2008 event consisted of two EF-4 tornadoes that were within the Joplin region. These tornadoes caused a total of 43 fatalities and 710 injuries, and the total damage was estimated at \$122 million. Table 2-8 summarizes key information about these events as well as the 1971 and 2011 tornadoes.

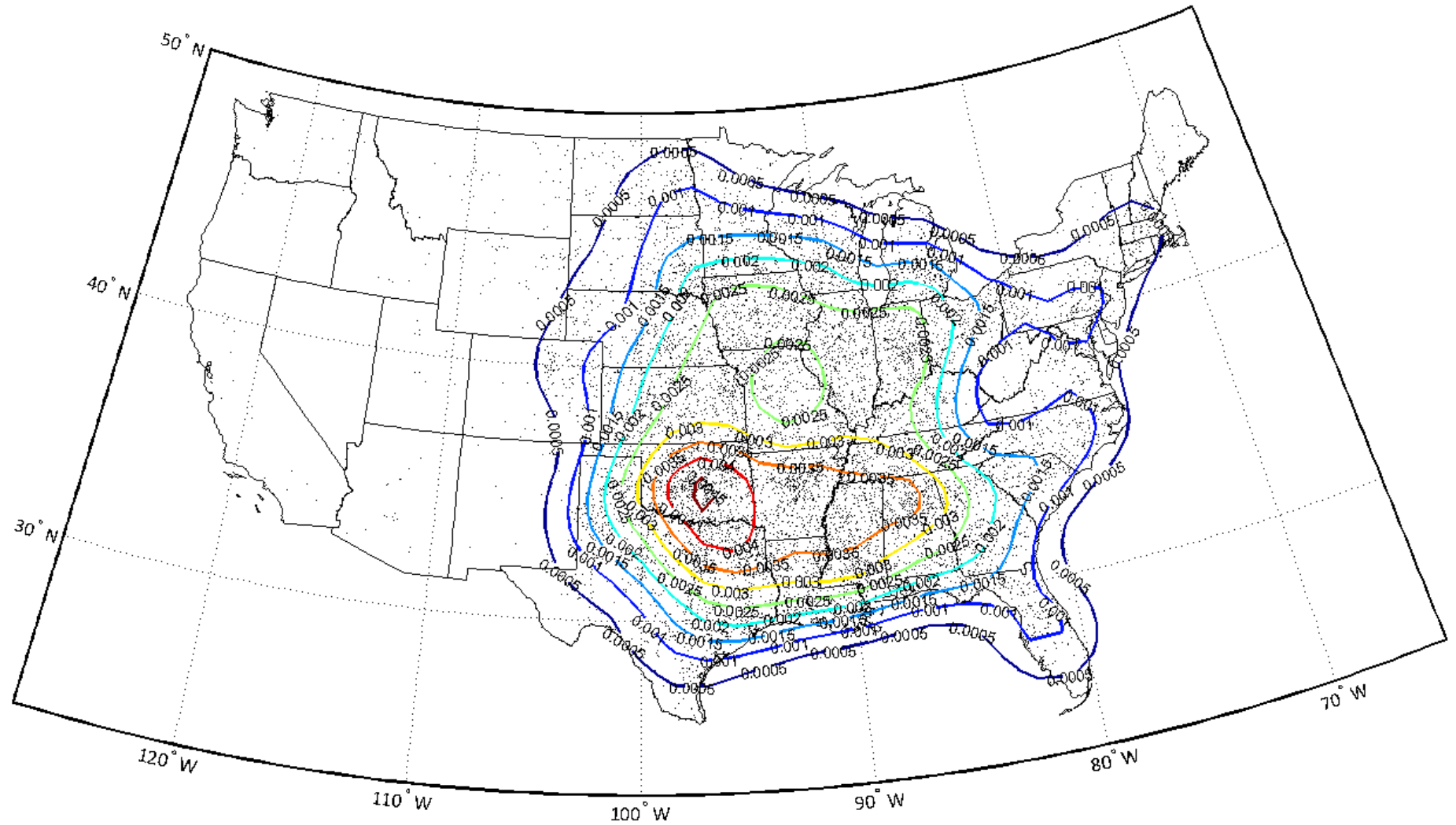

Data Source: NOAA. Analysis by NIST.

Figure 2–32. Probability density function of EF–2 or stronger tornadoes. Black dots represent individual touchdown locations. Warmer colors represent higher probability and probability values are shown on contour lines.

Spatial Distribution and Tornadoes/Year For (EF)2+Tornadoes

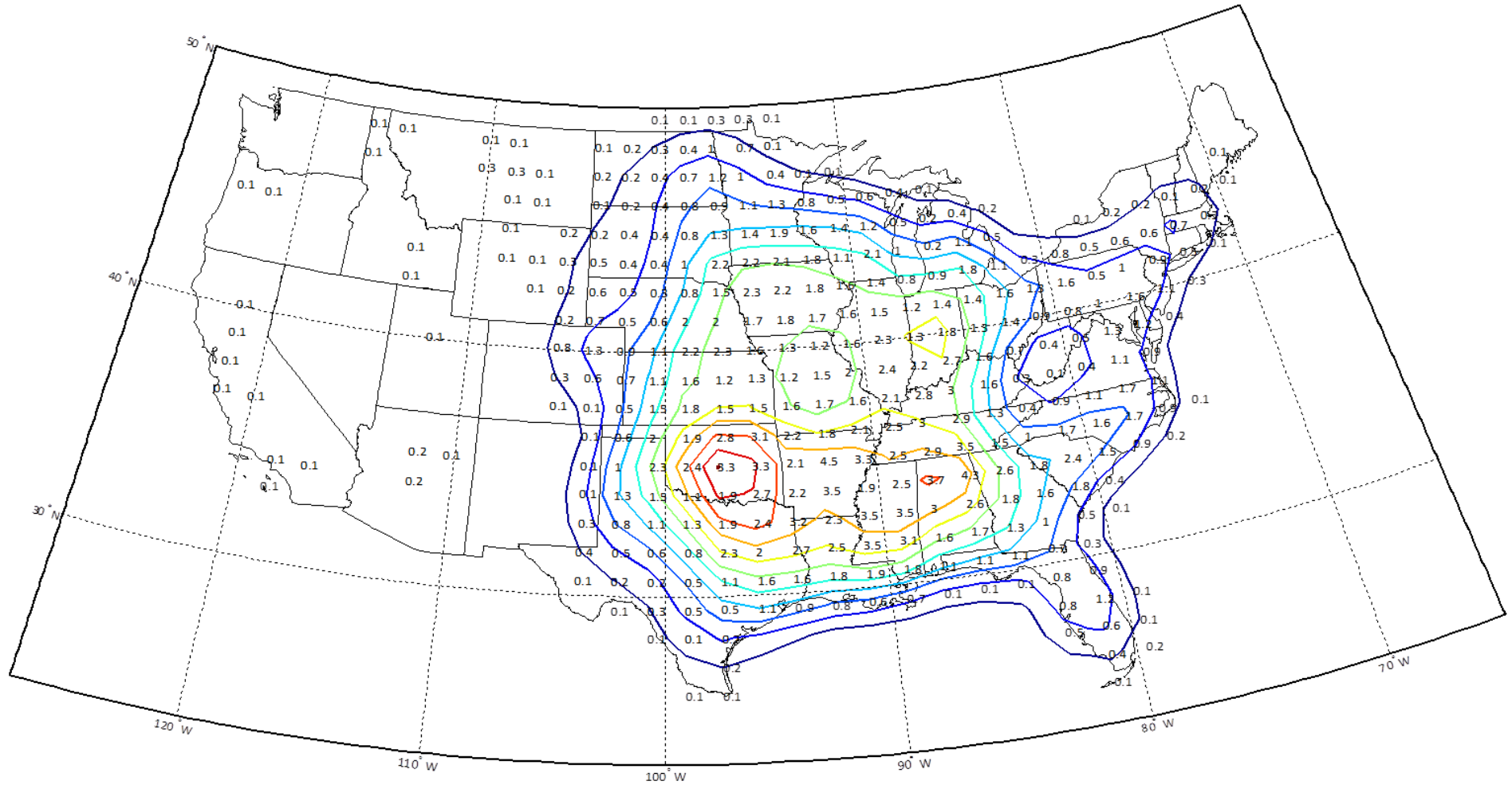

Data Source: NOAA. Analysis by NIST.

Figure 2– 33. Probability density of EF–2 or greater tornadoes from 1980 through 2011 with EF–2 or stronger tornadoes per year values shown at each grid point.

Table 2–8. Sample of significant tornado events in Joplin region.

Date	Location	Highest-Rated Tornado in Event	Fatalities (Event)	Injuries (Event)	Damage (Event, \$M)
April 3, 1956	Joplin Region	F–4	0	118	Unknown
May 5, 1971	City of Joplin	F–2	1	60	2.5
May 4, 2003	Joplin Region	F–3	17	116	95
May 10, 2008	Joplin Region	EF–4	43	710	122
May 22, 2011	City of Joplin	EF–5	161	> 1,000	3,000

The average number of tornadoes per year taken from the maps in Fig. 2–33 or Appendix F (e.g., Joplin = 2.0) can be used with a spatial area (e.g., city area) to arrive at an MRI for a tornado affecting *any* portion of that area. A tornado strike on any portion of that area would count as affecting the entire area. This spatially based approach becomes especially important when considering large incorporated areas in tornado-prone areas. For example, as of 2010, the city of Wichita, Kansas, had an area of approximately 159 square miles.⁵⁴ From the map in Fig. 2–33, the region including Wichita can be said to average approximately 1.5 EF–2 or stronger tornadoes per year. If the spatially based calculation is used as shown in the example in Fig. 2–31, the MRI for a tornado causing at least EF–2 damage anywhere within the Wichita city limits is approximately 84 years (1.5 tornadoes/year × 159 square miles ÷ 20,000 square miles). This MRI for Wichita is illustrated in Figure 2–34.

Large cities in tornado-prone areas, including Wichita, have been affected by multiple tornadoes rated EF–2 or greater. An EF–3 tornado inflicted damage within the city of Wichita in April 2012⁵⁵ and the F–5 Andover tornado in April 1991 also caused damage in Wichita. Other relatively large cities within the “high” hazard area, such as Birmingham and Tuscaloosa, Alabama, were affected by the April 2011 tornado outbreak (FEMA 2012) as well as a tornado outbreak in April 1998 (NWS 1998).

Figure 2–34 graphically shows the spatially based approach, with the tornado frequency per year on the x-axis. This information can be taken from Fig. 2–33 or Appendix F depending on the wind speed (i.e., EF number) of interest. The y-axis contains the spatial area measure, which can be defined by the user or taken from the U.S. Census Bureau if, for example, the area of interest is a city. Different areal measures are illustrated in Fig. 2–34 including Wichita, other incorporated areas including Joplin, and the traditional point-based (tornado-area) methodology for the Joplin area. The city of Joplin has a spatial area of 35.6 square miles according to the U.S. Census Bureau.⁵⁶ The contoured lines represent the MRI as calculated based on tornado frequency and spatial area as shown in Fig. 2–31.

⁵⁴ United States Census Bureau (<http://quickfacts.census.gov/qfd/states/20/2079000.html>).

⁵⁵ NOAA (http://www.crh.noaa.gov/news/display_cmsstory.php?wfo=ict&storyid=81890&source=0).

⁵⁶ United States Census Bureau (<http://quickfacts.census.gov/qfd/states/29/2937592.html>).

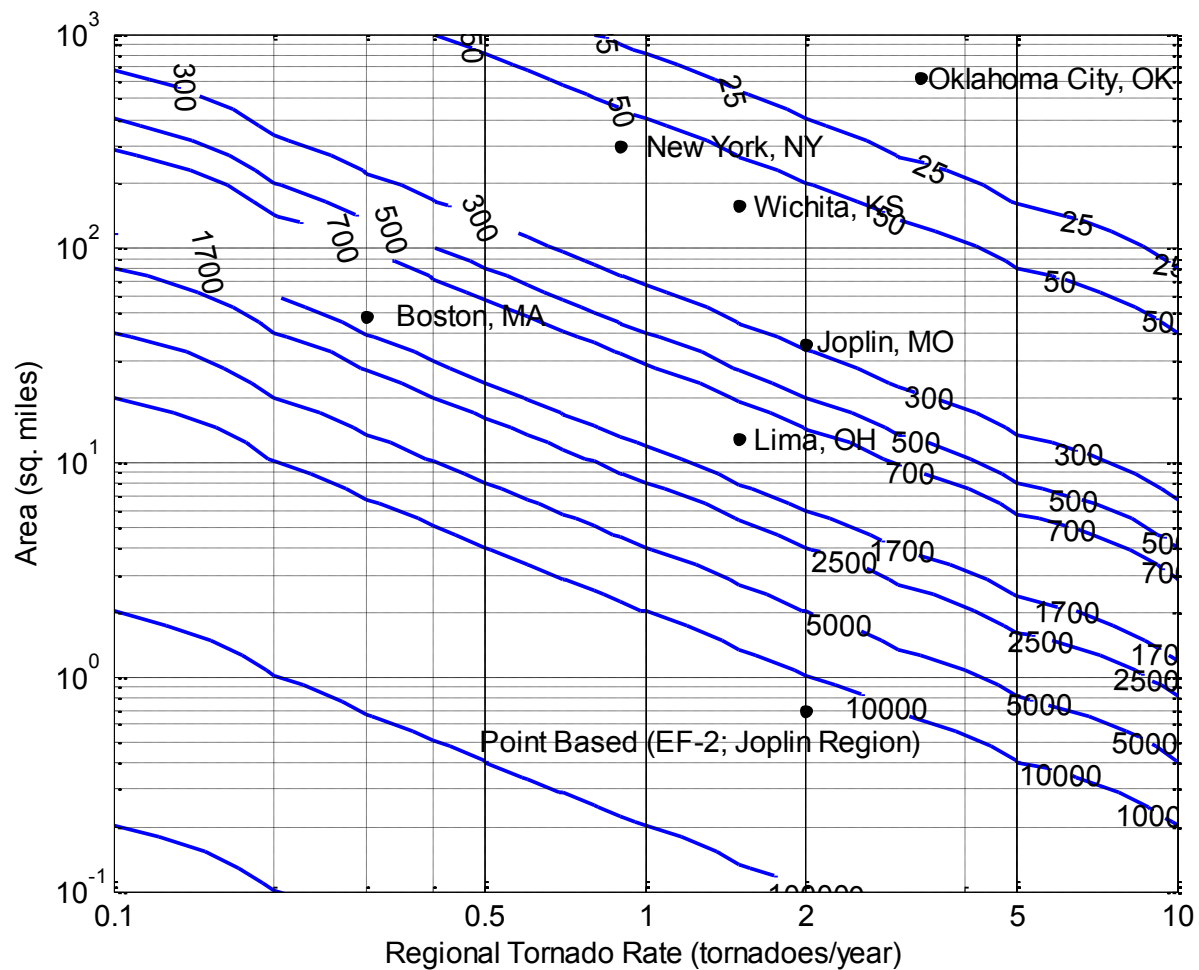

Figure 2– 34. Illustration of spatially based analysis. Contoured values are return period (MRI) in years for EF–2 or stronger tornadoes.

Once the area used becomes smaller than that of an average tornado (i.e., point-based), using the average tornado area in the calculation becomes conservative. Assuming a Poisson process, the probability of an EF–2 or stronger tornado affecting any portion of Joplin in a 50–year period is around 15 percent. For Wichita, the probability is approximately 45 percent. The tornado rates shown in Fig. 2–34 are for EF–2 and stronger tornadoes.

2.4.3 Urbanization of Communities

With the growing population of the United States and by extension the growing population of urban areas as opposed to rural, the vulnerability of communities to tornadoes (and hence their tornado risk) continues to increase. By 2011, the numbers of areas that would be considered urban instead of rural had increased substantially. This phenomenon was highlighted in a story from the *Joplin Globe*.⁵⁷ According to the

⁵⁷ (www.joplinglobe.com/tornadomay2011/x1315240161/Teams-of-scientists-looking-for-lessons-in-storm-s-aftermath).

story, the area occupied by Joplin a century ago was only 12.5 square miles and is now 35.6 square miles based on Census data, nearly three times the size. This increase in area obviously increases the risk of tornado strikes within the city limits. In the future, the square mileage of Joplin and communities like Joplin will likely increase further, putting more people and property at risk. Under a spatially based approach to tornado hazard analysis, increasing a community's area by a factor of three increases the chances of a tornado strike in any part of that community by the same factor.

2.5 ENHANCED FUJITA SCALE ASSESSMENT

2.5.1 Objective

In Sec. 2.5, the objective is to assess the current guidance, practices, and applications associated with the Enhanced Fujita (EF) Scale. As the EF Scale is the official rating scale for tornadoes, information from actual events can be drawn upon to help inform this assessment. Section 2.5.2 provides a brief history of the F and EF Scales, while Sec. 2.5.3 discusses current EF Scale guidance. Section 2.5.4 focuses on the implementation and usage of the EF Scale, especially in recent tornado events, including the Joplin tornado.

2.5.2 History

The original Fujita (F) Scale was developed by Dr. Ted Fujita from the University of Chicago in 1971 to distinguish between tornado intensities and provide a historical and working database for tornado climatology (TTU 2006). The F Scale was adopted for use by the NWS in the mid to late 1970s (Edwards et al. 2013) and was the primary method of rating tornadoes by assessing damage to structures for more than three decades. Although clearly the best method of its time, the F Scale was lacking in damage indicators (only photographic indicators of residential damage were initially used), did not account for differences in construction quality, rated only the worst damage, and provided no definitive correlation between damage and wind speed. These issues led researchers to spearhead an effort to reformulate the F Scale. The result of this effort was the Enhanced Fujita Scale (TTU 2006), which was implemented by the NWS in February 2007.

2.5.3 Current Practice/Guidance

The official document that prescribes how to rate tornadoes using the EF Scale is found on the Texas Tech University website (<http://www.depts.ttu.edu/nwi/Pubs/FScale/EFScale.pdf>). In response to criticisms of the original F Scale, the EF Scale document contains 28 damage indicators, or DIs. Each DI contains a series of degrees of damage (DODs), which represent the sequence of progressive wind damage. This information is also presented in Sec. 2.3.4.1, which discusses the EF ratings developed for structures surveyed by NIST following the Joplin tornado.

In addition, a detailed guide is available from the NWS (2003) on how to perform damage assessments and assign an F–Scale rating given the complexities in tornado dynamics, engineered structures, and other objects within a tornado's path. This document also outlines a “how-to” for putting together a storm survey team. Although this document was written for the F Scale, it can and should be easily applied to the EF Scale. Mentioned in this NWS (2003) document is the use of NWS Quick Response Teams

(QRT), which can be rapidly deployed in the event of a tornado suspected of producing greater than EF-3 damage.

If a tornado is suspected of producing greater than EF-3 damage, official guidance from *National Weather Service Instruction 10-1604*, dated July 29, 2011, states that if a “first review” done by the local NWS offices indicates “the situation is of national importance (e.g., a service assessment team may be fielded or the survey of damage will have significant scientific interest), they may request their region to recommend the activation of an OFCM (Office of the Federal Coordinator for Meteorological Services and Supporting Research) PSDA (Post-Storm Data Acquisition) QRT.” The instruction identifies five factors that should be considered in evaluating the need for an OFCM PSDA QRT⁵⁸:

1. Tornado or wind damage possibly greater than EF-3
2. Large number of deaths
3. Catastrophic damage
4. Profound coastal or inland flooding
5. Scientific interest

A QRT was not used in rating the Joplin tornado. However, QRTs were used in other violent tornadoes including the Greensburg, Kansas, EF-5 tornado in 2007,⁵⁹ the Parkersburg, Iowa, EF-5 tornado in 2008,⁶⁰ the Alabama tornado outbreak in 2011, which included EF-4 and EF-5 tornadoes (FEMA 2012). The Federal Emergency Management Agency (FEMA) recommended in their report on the Alabama tornadoes that QRTs should include a design professional (FEMA 2012), as only one of the Alabama surveys included an engineer.

2.5.4 Recent Observations Using the EF Scale

Although an improvement from its predecessor, the EF Scale has a number of issues that need to be addressed. A meeting of stakeholders (Edwards et al. 2013; Lombardo et al. 2010), which included meteorologists, wind engineers, and other relevant science and policy disciplines, was convened in 2010 to discuss these issues and set a direction for the future of the EF Scale. Attendees discussed further refinement of the damage/wind speed relationship due to the complexity of both tornado dynamics and structural resistance. In addition, they noted that the availability of well-trained surveyors is inadequate, especially in major events when NWS offices are extremely busy dealing with multiple storms and sometimes multiple tornadoes from the same event. Attendees also mentioned the ambiguity of the QRT process as a difficulty in assigning reliable ratings using the EF Scale, discussed the need to revise and add DIs, and called for a more rigorous scientific and engineering process for determining the EF rating for each event surveyed. Recently, Prevatt et al. (2012) stated that surrounding obstacles and debris effects need to be considered.

⁵⁸ NOAA (www.nws.noaa.gov/directives/sym/pd01016004curr.pdf).

⁵⁹ NOAA (<http://www.noaanews.noaa.gov/stories2007/s2855.htm>).

⁶⁰ NOAA (www.crh.noaa.gov/Image/dmx/ParkersburgSvcAssmntfinal.pdf).

That the current EF Scale lacks adequate DIs for distinguishing tornadoes on the upper end of the scale was evidenced in the Joplin tornado by the fact that indicators not in the EF Scale (e.g., tractor-trailers, manhole covers) were used as supplementary information in making the final EF-5 designation by the NWS. In fact, there are only five DIs that, upon reaching a sufficient DOD, indicate an EF-5 status, given an expected value of wind speed. The addition of both DI and DOD information at the upper end of the EF Scale should be a priority.

2.6 SUMMARY

2.6.1 Meteorological Conditions

Based on pre-storm meteorological information, the environment near Joplin was favorable for the development of tornadic thunderstorms. This environment was well forecast and anticipated by the NWS Storm Prediction Center. Tornado watches were issued over 4 hours before the tornado, and tornado warnings based on NWS radar information supplied a minimum lead time of 17 minutes for residents of Joplin. Although NWS radar correctly identified a possible tornado, the nearest radars were located a significant distance away from Joplin (about 100 km). This distance precluded any information regarding the near-surface wind field in and around the Joplin tornado. The tornado was on the ground in the city of Joplin for a time period of approximately 15 minutes.

2.6.2 Near-Surface Wind Environment

As no radar information was available on near-surface wind speeds, other methods were used to estimate the near-surface wind environment. Directly measured wind speed estimates were limited to those captured by a weather station at the Joplin Airport (KJLN). Although 5 miles to 6 miles away from the heaviest damage in the tornado, KJLN recorded sustained (2 minute) wind speeds of over 40 mph and gusts (3 s) over 50 mph. These wind speed magnitudes, coupled with wind directions that were coincident with the tornado position, suggest that the winds at the KJLN location were affected by the mesocyclone of the thunderstorm that produced the Joplin tornado for approximately 15 minutes. However, because no direct measurements were available within the damaged areas, indirect methods of estimating the near-surface wind environment were also developed.

The EF Scale was used to rate both selected damaged structures surveyed by NIST and a random sampling of the approximately 7,400 residential structures that were damaged. Wind speeds based on damage to selected NIST-surveyed structures were estimated to range from 140 mph \pm 15 mph to 150 mph \pm 15 mph (125 mph to 165 mph). NIST-estimated EF numbers and associated wind speed values for these structures were compared to those estimated by experienced researchers and practitioners and by other government agencies; variability was found in the degrees of damage, wind speeds, and eventual EF ratings. Residential structures in Joplin were given a general damage classification (light, medium, heavy/totaled, demolished) based on pre- and post-storm aerial photos. A random sample of 10 residential structures within each damage class was subjected to the EF-Scale procedure. On average, the four damage states corresponded to EF-0 (78 mph), EF-1 (93 mph), EF-2 (117 mph), and EF-3 (144 mph) damage, respectively, with a maximum EF-based estimated wind speed of 175 mph, among the 40 residential structures surveyed.

In addition to the EF–Scale estimation, thousands of trees felled in Joplin by the tornado provided the opportunity to estimate wind speed by “fitting” a Rankine vortex model to the locations and directions of observed tree fall. A citywide grid was created to enable estimation of wind speed and direction as well as to create outputs that could be compared with observed tree fall. The Rankine vortex model was parameterized using full factorial design with plausible ranges of input parameters estimated from damage in Joplin and from previous tornado studies. These ranges were narrowed by comparing the model outputs with observed values for parameters such as damage width, damage ratio, and tree fall angle using interaction effect plots. The narrowed parameter ranges were then used as final values in the Rankine vortex model and provided uncertainty bounds for the final wind speed estimation.

Damage width (DW) of tree fall in the Joplin area was up to 1 mile (about 1,600 m) and was generally above 0.9 miles (about 1,450 m). This width is in accordance with the estimate of tornado width issued by the NWS office in Springfield. The damage ratio (DR) generally ranged from 2.0 to 2.3.

The radius of maximum wind (RMW) based on tree fall analysis was estimated to range from 0.07 miles (113 m, 370 ft) to possibly a maximum of approximately 0.18 miles (290 m, 950 ft) with the average estimated value being 0.16 miles (258 m, 845 ft). These RMW values are within the radar–measured ranges of other violent tornadoes. The values of alpha (α) were estimated to range from 15 degrees to 25 degrees. This implies a significant radial component to the flow in the near surface (i.e., purely radial flow, $\alpha = 0$ degrees) as opposed to a purely tangential flow ($\alpha = 90$ degrees) as has been suggested by meteorological and engineering–based studies. Phi (ϕ) values (0.6 to 0.7) were similar to those in other observed vortex phenomena, but differed from values traditionally used in engineering– or probabilistic–based models.

Lower values of ϕ , as well as a relatively slow translation speed and a more radial flow, may have caused both a longer duration and larger spatial extent of significant wind speeds. Based on the tree fall best estimation, some areas experienced EF–2 wind speeds or greater for over 1 minute, and the majority of those areas experienced EF–2 or greater wind speeds for 30 s or more. Approximately 30 percent of the tornado–affected area experienced wind speeds of EF–2 or greater, which is greater than the percentage estimated by traditional probabilistic–based engineering models.

Based on the best estimated parameters of the Rankine vortex model, maximum wind speeds based on tree fall were estimated to be in general 175 mph \pm 35 mph throughout the areas of highest damage in Joplin, suggesting that the tornado maintained its intensity during its time in the city. However, because tree fall, like other indirect methods, relies on an indicator (i.e., presence of trees) to estimate wind speed, it is entirely possible that maximum wind speeds were above the values provided in this report. The maximum wind speeds estimated by tree fall for specific structures surveyed by NIST were similar to the wind speeds estimated by EF–Scale methods; however, a wider range was displayed due to the larger spatial extent of some of these structures (e.g., Walmart), which can be incorporated by the Rankine model.

Tree fall and aerial damage patterns also seemed to suggest that the tornado underwent considerable directional changes over the course of its path through Joplin, and that five to six vortices were present in the earlier stages of the tornado. Although analyzing tree fall was extremely helpful in determining the near–surface wind field, additional study is needed on this topic and on other indirect estimations of wind speed.

2.6.3 Description of the U.S. Tornado Hazard

Current methodologies for assessing tornado hazard using “point-based” estimations for probability of occurrence in the United States were discussed. Point-based tornado hazard estimations use a conditional, areal probability approach that takes into account both tornado strike probability and the probability of wind speed exceeding a certain threshold. Information discovered in the Joplin tornado and in other recent tornado events involving populated areas suggests that “point-based” (i.e., tornado area-based) estimation of the tornado hazard may need to be reevaluated. This information includes actual damage probabilities that were higher than those derived through EF Scale and tornado wind field estimations.

As an alternative to point-based approximations, a spatially based approach was demonstrated for the United States based on a regional tornado rate developed from the NOAA database and the areas (sizes) of particular locations, including cities. As nearly all human and economic losses from tornadoes were attributed to EF-2 or greater tornadoes based on the NOAA database, the subset of EF-2 or stronger tornadoes was examined in the spatially based approach. The areas of particular locations were used instead of the tornado-affected areas used in previous point-based climatology. For larger areas, such as those in large cities, the spatially based approach produces a probable rate of EF-2 or greater tornado strikes that is significantly higher than what is considered in traditional point-based estimations as has been corroborated in earlier tornado hazard studies. As urban areas continue to increase in size and population, the risk from tornadoes in a spatially based framework also increases.

2.6.4 Enhanced Fujita Scale Assessment

Current practice and guidance associated with the EF Scale was discussed, especially for violent tornadoes (greater than EF-3). If a tornado is suspected of producing greater than EF-3 damage, causes numerous fatalities and catastrophic damage, and is of scientific interest, official NWS guidance states that local NWS offices may request the deployment of an NWS Quick Response Team, or QRT. These teams are groups of wind damage experts from around the country who, if deployed, have input into the final EF rating. A QRT was not deployed in the Joplin tornado; however, they have been used in recent violent tornado events such as those in Greensburg, Kansas, Parkersburg, Iowa, and Tuscaloosa, Alabama.

The research described in Sec. 2.5 and other research that has been conducted outside of NIST both suggest that further procedural and scientific improvements need to be made to the EF Scale itself. Specifically, the current EF Scale lacks adequate damage indicators, especially for distinguishing tornadoes at the higher end of the scale. No guidance is provided in the EF Scale for rating of large buildings having significant variations of damage as described in Sec 2.3.4.1, leading to ambiguity in the assignment of EF numbers.

2.7 REFERENCES

- ANS (American Nuclear Society). 2011. *Estimating Tornado, Hurricane, and Extreme Straight Line Wind Characteristics at Nuclear Facility Sites: An American National Standard*. ANSI/ANS-2.3-2011. La Grange Park, IL.
- ASCE (American Society of Civil Engineers). 2010. *Minimum Design Loads for Buildings and Other Structures*. ASCE Standard ASCE/SEI 7-10. Reston, VA.
- Bech, J., M. Gaya, F. Aran, J. Figuerola, and J. Arus. 2009. Tornado damage analysis of a forest area using site survey observations, radar data and a simple vortex model. *Atmospheric Research*, 93, 118–130.
- Beck, V. and N. Dotzek. 2010. Reconstruction of near-surface tornado wind fields from forest damage. *Journal of Applied Meteorology and Climatology*, 49, 1517–1537.
- Bluestein, H. B. 2007. Mobile Doppler radar observations of tornadoes. Preprints, Fourth European Conference on Severe Storms, Trieste, Italy.
- Bluestein, H. B., W. C. Lee, M. Bell, C. C. Weiss, and A. Pazmany. 2003. Mobile Doppler radar observations of a tornado in a supercell near Bassett, Nebraska, on 5 June 1999: Part II, Tornado-vortex structure. *Monthly Weather Review*, 131, 2968–2984.
- Box, G. E. P., J. S. Hunter, and W. G. Hunter. 2005. *Statistics for Experimenters: Design, Innovation and Discovery*. Wiley-Interscience, 664 pp.
- Brooks, H. E., C. D. Doswell III, and M. P. Kay. 2003a. Climatological estimates of local daily tornado probability for the United States. *Weather and Forecasting*, 18, 626–640.
- Brooks, H. E., J. W. Lee, and J. P. Craven. 2003b. The spatial distribution of severe thunderstorm and tornado environments from global reanalysis data. *Atmospheric Research*, 67–68, 73–94.
- Burgess, D. W., M. A. Magsig, J. Wurman, D. C. Dowell, and Y. Richardson. 2002. Radar observations of the 3 May 1999 Oklahoma City tornado. *Weather and Forecasting*, 17, 456–471.
- Church, C. R. 1993. *The Tornado: Its Structure, Dynamics, Prediction and Hazards*. American Geophysical Union, 630 pp.
- Coulbourne, W. L., and Miller, J. 2012. Performance of school buildings in the Joplin, MO tornado. *Proceedings of the 43rd ASCE/SEI Structures Congress*. Chicago, IL, March 29–31.
- Davies-Jones, R., R. J. Trapp, and H. B. Bluestein. 2001. Tornadoes and tornadic storms. *Meteorological Monographs*, 28, 167–222.
- Dixon, P. G., A. E. Mercer, J. Choi, and J. Allen. 2011. Tornado risk analysis: Is Dixie Alley an extension of Tornado Alley? *Bulletin of the American Meteorological Society*, 92, 433–441.

- DOE (U.S. Department of Energy). 2000. *Development of a Probabilistic Tornado Wind Hazard Model for the Continental United States*. Prepared by Boissonade et al. UCRL-ID-140922-VOL-1.
- Dotzek, N. 2009. Derivation of physically motivated wind speed scales. *Atmospheric Research*, 93, 564–574.
- Edwards, R., J. G. LaDue, J. T. Ferree, K. Scharferberg, C. Maier, and W. L. Coulbourne. 2013. Tornado intensity estimation: Past, present and future. *Bulletin of the American Meteorological Society*, 94, 641–653
- FEMA (Federal Emergency Management Agency). 2008. *Design and Construction Guidance for Community Safe Rooms*. FEMA P-361, Second Edition. Washington, DC, August.
- FEMA (Federal Emergency Management Agency). 2012. *Spring 2011 Tornadoes: April 25–28 and May 22, Building Performance Observations, Recommendations and Technical Guidance*. Mitigation Assessment Team Report. FEMA P-908. Washington, DC, May.
- Garson, R.C., J.M. Catalan and C.A. Cornell. 1975. Tornado design winds based on risk. *Journal of the Structural Division*, 101, No. ST9
- Holland, A. P., A. J. Riordan, and E. C. Franklin. 2006. A simple model for simulating tornado damage in forests. *Journal of Applied Meteorology and Climatology*, 45, 1597–1611.
- ICC (International Code Council). 2008. *Standard for the Design and Construction of Storm Shelters*. ICC 500–2008.
- Karstens, C., W. Gallus, and P. Sarkar. 2012. *Joplin, MO Tornado Damage Survey Report*. Internal Document, Iowa State University.
- Karstens, C., W. A. Gallus, B. D. Lee, and C. A. Finley. 2013. Analysis of tornado-induced tree-fall using aerial photography from the Joplin, MO, and Tuscaloosa–Birmingham, AL, tornadoes of 2011. *Journal of Applied Meteorology and Climatology*, 52, 1049–1068.
- Kopp, G. A., and M. J. Morrison. 2011. Discussion of “tornado-induced wind loads on a low-rise building. *Journal of Structural Engineering*, 137, 1620–1622.
- Kosiba, K., and J. Wurman. 2010. The three-dimensional axisymmetric wind field structure of the Spencer, South Dakota, 1998 tornado. *Journal of the Atmospheric Sciences*, 67, 3074–3083.
- Lewellen, D. 2012. Effects of topography on tornado dynamics: A simulation study. *Proceedings of the 12th Conference on Severe Local Storms*. Nashville, TN, November 4–8.
- Lombardo, F. T., T. M. Brown, J. A. Womble, and J. G. LaDue. 2010. The future of the EF-scale. *Proceedings of the 2nd American Association for Wind Engineering Workshop*. Marco Island, FL, August 19–20.

- Mallen, K. J., M. T. Montgomery, and B. Wang. 2005. Reexamining the near-core radial structure of the tropical cyclone primary circulation: Implications for vortex resiliency. *Journal of the Atmospheric Sciences*, 62, 408–425.
- Markowski, P., and Y. Richardson. 2010. *Mesoscale Meteorology in the Midlatitudes*. Wiley–Blackwell, 430 pp.
- Marshall, T. P. 2002. Tornado damage survey at Moore, Oklahoma. *Weather and Forecasting*, 17, 582–598.
- Marshall, T. P. 2012. Performance of concrete masonry buildings in the Joplin tornado. *Proceedings of the 92nd American Meteorological Society Annual Meeting*. New Orleans, LA, January 22–26.
- Marshall, T. P., W. Davis, and S. Runnels. 2012. Damage survey of the Joplin tornado: May 22, 2011. *Proceedings of the 12th Conference on Severe Local Storms*. Nashville, TN, November 4–8.
- Milton, J. S., and J. Arnold. 2003. *Introduction to Probability and Statistics: Principles and Applications for Engineering and the Computing Sciences*. McGraw–Hill, 816 pp.
- NRC (U.S. Nuclear Regulatory Commission). 2007. *Tornado Climatology of the Contiguous United States*. Prepared by Pacific Northwest National Laboratory. NUREG/CR–4461.
- NRCa (National Research Council). 1993. *Wind and the Built Environment: U.S. Needs in Wind Engineering and Hazard Mitigation*, NRC Press, 130 pp.
- NWS (National Weather Service). 1998. *Service Assessment: Southeastern United States Tornadoes April 8, 1998*. Available online at www.nws.noaa.gov/om/assessments/pdfs/setornad4–98.pdf.
- NWS (National Weather Service). 2003. A Guide to F–Scale Damage Assessment. Available online at www.wdtb.noaa.gov/courses/ef–scale/lesson2/FinalNWSF–scaleAssessmentGuide.pdf, 101 pp.
- NWS (National Weather Service). 2011. *NWS Central Region Service Assessment Joplin, Missouri, Tornado—May 22, 2011*. 34 pp.
- Peterson, C.J. 2003. Factors influencing treefall risk in tornadoes in natural forests. Preprints, *Symposium on F–Scale and severe weather damage assessment*, Long Beach, CA
- Potvin, C. K., A. Shapiro, T. Yu, J. Gao, and M. Xue. 2009. Using a low-order model to detect and characterize tornadoes in multiple–Doppler radar data. *Monthly Weather Review*, 137, 1230–1249.
- Prevatt, D. O., D. B. Roueche, J. W. Van DeLindt, S. Pei, T. Dao, B. Coulbourne, A. Graettinger, R. Gupta, and D. Grau. 2012. Building damage observations and EF classifications from the Tuscaloosa, AL and Joplin, MO tornadoes. *Proceedings of the 43rd ASCE/SEI Structures Congress*. Chicago, IL, March 29–31.
- Reinhold, T. and B. Ellingwood. 1982. *Tornado Damage Risk Assessment*. NUREG/CR–2944.

- Roueche, D. B., and D. O. Prevatt. 2013. Residential damage patterns following the 2011 Tuscaloosa, AL and Joplin, MO tornadoes. *Proceedings of the 1st Annual Residential Building Design and Construction Conference*. Bethlehem, PA, February 20–21.
- Silverman, B. W. 1986. *Density Estimation for Statistics and Data Analysis*. Chapman and Hall.
- Speheger, D. A., C. A. Doswell III, and G. J. Stumpf. 2002. The tornadoes of 3 May 1999: Event verification in central Oklahoma and related issues. *Weather and Forecasting*, 17, 362–381.
- TTU (Texas Tech University). 2006. *A Recommendation for an Enhanced Fujita Scale*. Available online at <http://www.depts.ttu.edu/nwi/pubs/FScale/EFScale.pdf>, 111 pp.
- Twisdale, L.A. and W.L. Dunn. 1983. Probabilistic analysis of tornado wind risks. *Journal of Structural Engineering*, 109, 468–488
- Van de Lindt, J. W., S. Pei, T. Dao, A. Graettinger, D. O. Prevatt, R. Gupta, and W. Coulbourne. 2013. Dual-objective-based tornado design philosophy. *Journal of Structural Engineering*, 139, 251–263.
- Verbout, S. M., H. E. Brooks, L. M. Leslie, and D. M. Schultz. 2006. Evolution of the US tornado database: 1954–2003. *Weather and Forecasting*, 21, 86–93.
- Wood, V. T., and R. A. Brown. 2011. Simulated tornadic vortex signature of tornado-like vortices having one and two-celled structures. *Journal of Applied Meteorology and Climatology*, 50, 2338–2342.
- Wurman, J., and C. R. Alexander. 2005. The 30 May 1998 Spencer, South Dakota, storm. Part II: Comparison of observed damage and radar-derived winds in the tornadoes. *Monthly Weather Review*, 133, 97–119.
- Wurman, J., and S. Gill. 2000. Fine-scale radar observations of the Dimmitt, Texas tornado. *Monthly Weather Review*, 128, 2135–2164.
- Wurman, J., C. Alexander, P. Robinson, and Y. Richardson. 2007. Low-level winds in tornadoes and potential catastrophic impacts in urban areas. *Bulletin of the American Meteorological Society*, 88, 31–46.

Chapter 3

PERFORMANCE OF BUILDINGS, DESIGNATED SAFE AREAS, AND LIFELINES

3.1 INTRODUCTION

3.1.1 Overall Extent of Damage

The May 22, 2011, Joplin tornado affected thousands of residential, commercial, and institutional facilities in Jasper and Newton Counties in Missouri. According to fact sheets from the Joplin Area Chamber of Commerce (May 1, 2012)⁶¹ and the City of Joplin (May 14, 2012),⁶² and to the May 22, 2012, Joplin Community Press Kit,⁶³ the City of Joplin alone—which bore the brunt of the tornado damage—had a total of 553 businesses that sustained severe damage and just over 7,400 residential buildings that were damaged to some degree (about 43 percent, or 3,181, of these residential buildings were considered destroyed, i.e., structures with a damage classification of *heavy/totaled* or *demolished*). A general breakdown of affected facilities and buildings based on their functions, derived from the above sources and NIST’s analysis of Pictometry[®] damage data, indicates the following:

- **One of the two major hospitals**, St. John’s Regional Medical Center was damaged severely. The other hospital, Freeman Health System, was unaffected.
- **Ten public and several parochial schools**. Those that sustained severe damage and building collapses included Joplin High School, Joplin East Middle School, Franklin Technology Center, Irving Elementary School, St. Mary’s Catholic Elementary School, and Emerson Elementary School. Those damaged less severely included Cecil Floyd Elementary School, Duquesne Elementary School, Kelsey Norman Elementary School, and the Roi S. Wood Administration Building.
- **Twenty-eight churches**, which suffered varying degrees of damage.
- **Two fire stations** (No. 2 and No. 4) with partial loss of roof.
- A large number of **commercial facilities**, including **high-occupancy and smaller buildings** (big-box stores, medical/dental offices, banks, etc.).
- **7,411 residential buildings (all were single homes and apartment buildings)**. Data compiled by the Missouri Housing Development Commission⁶⁴ indicated that about half of the areas within the tornado damage path had high concentrations of rental properties (i.e., 42 percent to 68 percent of the households rented their homes), and the other half had somewhat

⁶¹ <http://regionalpartnership.contros.com/JACC%20Fact%20Sheet%205-1-12.pdf>.

⁶² www.joplintornadoanniversary.com/resources/city-of-joplin-factsheet5-14-12.pdf.

⁶³ www.joplintornadoanniversary.com/resources/community-press-kit.pdf.

⁶⁴ www.mhdc.com/notices/tda/documents/Joplin_Data.pdf.

lower rental property concentrations (13 percent to 42 percent of households rented their homes). This suggested that, of the 20,820 people living in the affected area (41 percent of Joplin’s population of 50,175 based on 2010 U.S. Census data⁶⁵), many resided in rental units (an August 6, 2011, article in the *Joplin Globe*⁶⁶ put the number of rental units destroyed at 4,600). In general, this portion of the population was more vulnerable to tornadoes, as they largely depended on apartment construction for protection and did not have the ability to construct their own shelters.

In terms of economic loss, the May 14, 2012, City of Joplin fact sheet,² quoting data provided by the Missouri Department of Insurance, Financial Institutions, and Professional Registration, put the insured losses incurred by commercial property owners at \$1.228 billion and residential property owners at \$0.552 billion as of April 30, 2012 (with most expected claims received). Thus, losses from building damage alone, not counting damage to automobiles and other property, totaled about \$1.78 billion by April 30, 2012.

While many of the affected buildings did not collapse, there were many occupants killed or injured by the tornado. Table 3–1 provides a brief summary of the building–related fatalities and property loss incurred in the Joplin tornado. In–depth analysis of the circumstances and factors surrounding the fatalities and injuries is provided in Chapter 4 of this report.

Table 3–1. Summary of building–related losses from the Joplin tornado.

Buildings Damaged	Residential	7,411
	Non–Residential	553
Fatalities	Total	161
	All Building–Related	135 (of 161, or 83.8% of total fatalities)
	Residential Building Related	80 (of 135, or 59% of building–related fatalities)
Insured Losses (as of April 30, 2012)	Residential Property	\$0.552 billion
	Commercial Property	\$1.228 billion

Besides the damage to facilities, the tornado also caused significant damage to lifeline systems (electricity, water, and gas) in the affected areas, including those pertaining to:⁶⁷

- Electricity—

⁶⁵ www.census.gov/newsroom/emergencies/2011_tornadoes.html.

⁶⁶ “Tornado poses questions about putting shelters in apartment buildings” Wally Kennedy, The Joplin Globe, Joplin, MO. August 6, 2011

⁶⁷ www.joplintornadoanniversary.com/resources/community-press-kit.pdf.

There was severe damage to the **regional electrical transmission and distribution infrastructure** (high-voltage lines, towers, poles, and substations controlled by Empire District Electric) as well as to in-facility distribution systems (lines and fixtures controlled and used within individual buildings), resulting in a loss of electrical power for about 20,000 customers immediately after the May 22, 2011 tornado. Specific tornado impacts included two step-down substations damaged and one completely destroyed; approximately 4,000 distribution poles and transmission towers damaged; roughly 1,500 transformers damaged; and about 110 miles of transmission/distribution lines downed.

- Water—
Numerous service lines were broken and leaked water throughout the disaster area. The damage included about 4,000 leaking service lines and 25 broken fire-service lines, which caused a drastic decrease in water pressure and loss of water from two elevated storage tanks within 2 hours after the tornado struck.
- Gas—
Approximately **3,500 gas meters and 55,000 ft of gas main were damaged**, affecting 3,500 customers.

The sections that follow review building codes and standards issues pertaining to tornado-resistant design and the City of Joplin's code adoptions prior to the tornado. This provides context for the ensuing analysis of the performance of different types of buildings that were affected by the May 22, 2011, Joplin tornado, the areas of refuge within them, and the lifeline systems related to their operation.

3.1.2 Scope of Structures Surveyed and of This Chapter

During field deployments following the May 22, 2011, Joplin tornado, NIST selected 25 structures, out of the 7,964 damaged residential and non-residential buildings, for on-site surveys of their performance during the tornado. The selected structures included institutional, commercial, and residential buildings that were representative of typical construction types, building functions, and levels of damage in the affected area. The construction types represented included steel moment resisting frame,⁶⁸ steel braced frame, concrete moment resisting frame, box-type system (BTS)⁶⁹ with concrete masonry unit (CMU) wall, BTS with precast tilt-up concrete wall, light steel frame, unreinforced brick, and wood frame. By function, the surveyed buildings included critical facilities such as a hospital, schools, and fire and police stations; high-occupancy facilities such as large retail stores and churches; smaller medical and commercial offices; as well as a nursing home and single- and multi-family residences. Besides buildings, several lifeline facilities were also surveyed, including a power substation, a water treatment

⁶⁸ The moment resisting frame system is one of two basic types of lateral load resisting systems commonly used in engineered buildings (the other is the box-type system). Some buildings may be designed with a dual system containing both types for a more redundant lateral load system. In steel or concrete moment resisting frame, the lateral load resistance is provided primarily by the interconnection of floor beams/girders and the columns (through rigid beam-column joints), and the gravity load is provided by the floor and roof diaphragms and the columns.

⁶⁹ The box-type system (BTS) is one of two basic types of lateral load resisting systems commonly used in engineered buildings (the other is the moment resisting frame system). BTS buildings are buildings with exterior walls (typically made of either CMU or precast concrete walls) that form the "box" and provide both gravity and lateral load resistances. However, the stability of the exterior walls is critically dependent upon the connection to, and the stiffness of, the roof system (which forms the "lid" of the "box" and serves as a diaphragm providing lateral bracing for, and transferring lateral loads, to the exterior walls).

plant, and structures housing backup generators and chiller equipment for St. John’s Regional Medical Center (SJRMC).

Table 3–2 groups the NIST–surveyed buildings into engineered⁷⁰ versus non– or marginally engineered⁷¹ categories and summarizes their damage conditions. Fig. 3–1 through 3–3 show the locations of these buildings along the tornado damage path. The color coding on these figures depicts the damage conditions of these and other buildings, including residential construction, as estimated by Pictometry®.

Following its field surveys, NIST worked with third parties, including the Joplin Public Works Department, relevant building owners (such as the Sisters of Mercy, the parent organization of SJRMC), relevant architectural and engineering design firms (Patterson Latimer Jones Brannon Denham (PLJBD) and Heery International, Inc.), and the Structural Engineers Association of Kansas and Missouri (SEAKM) to obtain design information about the NIST–surveyed buildings. For various reasons (e.g., age, damage to records), NIST was unable to obtain complete design information for all of the buildings that were surveyed. The last three columns of Table 3–2 summarize the basic design information that pertains to the buildings surveyed by NIST, including types of construction, applicable building codes, and whether NIST was able to obtain complete, partial, or no design information for the respective building. Note that all of the engineered buildings that sustained partial or total structural collapse were BTS buildings with either concrete masonry or tilt–up precast concrete perimeter walls.

This chapter examines the performance of the NIST–surveyed buildings, including designated safe areas within these buildings, as well as the performance of lifeline systems that pertain to building operations. Chapter 3 includes the following sections:

- Section 3.1.3 describes the methodology and technical approach that NIST used in evaluating the performance of buildings in this Technical Investigation.
- Section 3.1.4 describes current national approaches to tornado design, to provide proper context for the effects resulting from the May 22, 2011, Joplin tornado.
- Section 3.1.5 summarizes the City of Joplin’s history of adopting building codes.
- Section 3.2 describes the performance of the NIST–surveyed buildings (critical facilities and high–occupancy buildings in Sec. 3.2.1, commercial buildings in Sec. 3.2.2, and residential buildings in Sec. 3.2.3); it includes design and damage information, and in cases where structural failures occurred and design information was available, descriptions of possible failure hypotheses developed based on the methodology described in Sec. 3.1.3.
- Section 3.3 evaluates the performance of designated safe areas found in the surveyed buildings (Sections 3.3.1 through 3.3.3) and the performance of individual residential shelters (Sec. 3.3.4).

⁷⁰ Engineered buildings: Buildings that are designed to satisfy specific design requirements stipulated by building codes through use of structural engineering analysis and calculation.

⁷¹ Non- or Marginally engineered buildings: Buildings that are constructed in accordance with prescriptive requirements of the building codes but with minimal or no use of structural engineering analysis and calculation.

Table 3–2. List of NIST–surveyed buildings with damage condition and design information.

	Damage Condition			Design Information		
	Collapse of Main Wind Force Resisting System (MWFRS)	Damage/Loss of Roof and/or Wall Cladding	Loss of Functionality	Construction Type	Building Code	Drawings Obtained by NIST
Engineered ¹⁰	Walmart		Complete	BTS (CMU)	BOCA 1990/IBC 2000	Complete
	Joplin East Middle School Auditorium		Complete	BTS (CMU)	IBC 2000	Complete
	St. Mary’s School		Complete	BTS (CMU)	BOCA NBC/1990	Partial
	Franklin Technology Center		Complete	BTS (CMU)	BOCA BBC/1978	Partial
	SJRMG Generator and Chiller Buildings		Complete	BTS (CMU)	Not known	Partial
	Home Depot		Complete	BTS (Tilt–up)	BOCA NBC/1996	Complete
	Joplin East Middle School Gymnasium		Complete	BTS (Tilt–up)	IBC 2000	Complete
		SJRMG Hospital Buildings	Complete	CF, SF	Not known	Partial
		St. Paul’s United Methodist Church	Complete	SF	BOCA NBC/1996	Partial
		Joplin High School Buildings	Complete	CF, SF	IBC 2000	Partial
		Ramesh Shaw Center	Complete	SF	BOCA NBC/1990	Partial
		William Meredith Center	Complete	SF	Not known	None
		Ozark Center for Autism	Complete	CF	Not known	Partial
Non–/Marginally Engineered ¹¹	Single– and multi–family homes	Single– and multi–family homes	Complete/Partial/No	WF	Various years	None
		Mercy Village	Partial	WF	IBC 2000	Partial
		Swanson Office Building	Partial	WF	IBC 2006	Complete
		Fire and Police Stations	Partial	WF	Not known	None

Key: BTS, Box–Type System; CF, Concrete Frame; SF, Steel Frame; WF, Wood Frame; CMU, Concrete Masonry Unit; BOCA, Building Officials and Code Administrators International, Inc.; NBC, National Building Code; BBC, Basic Building Code; IBC, International Building Code.

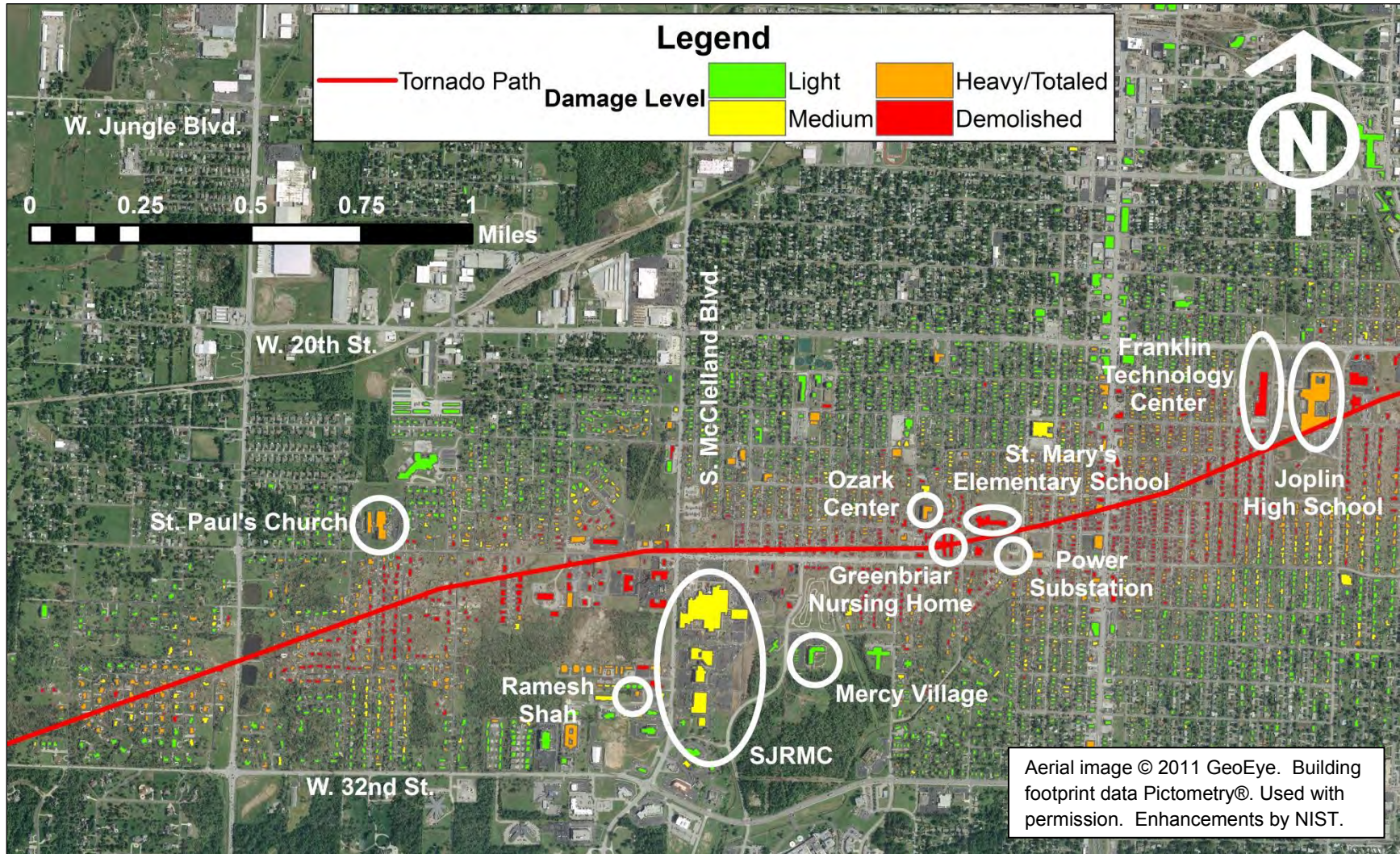

Figure 3–1. Westernmost (earliest) segment of the tornado path through Joplin, showing locations of facilities surveyed by NIST relative to the estimated center line of the tornado damage path (red solid line). The color coded building footprints indicate the estimated level of damage to individual structures (see legend above).

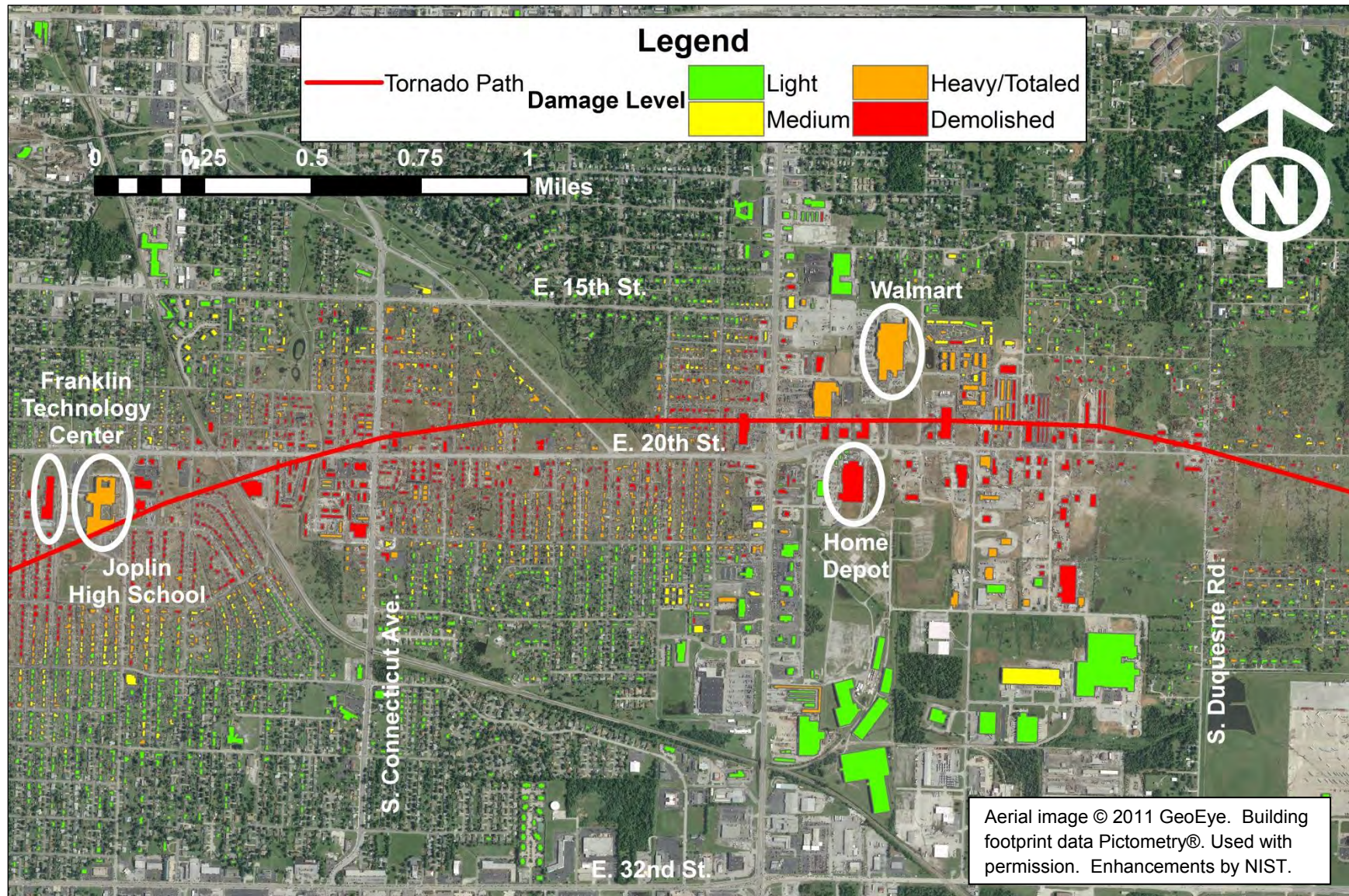

Figure 3–2. Central segment of the tornado path through Joplin, showing locations of facilities surveyed by NIST relative to the estimated center line of the tornado damage path (red solid line). The color coded building footprints indicate the estimated level of damage to individual structures (see legend above).

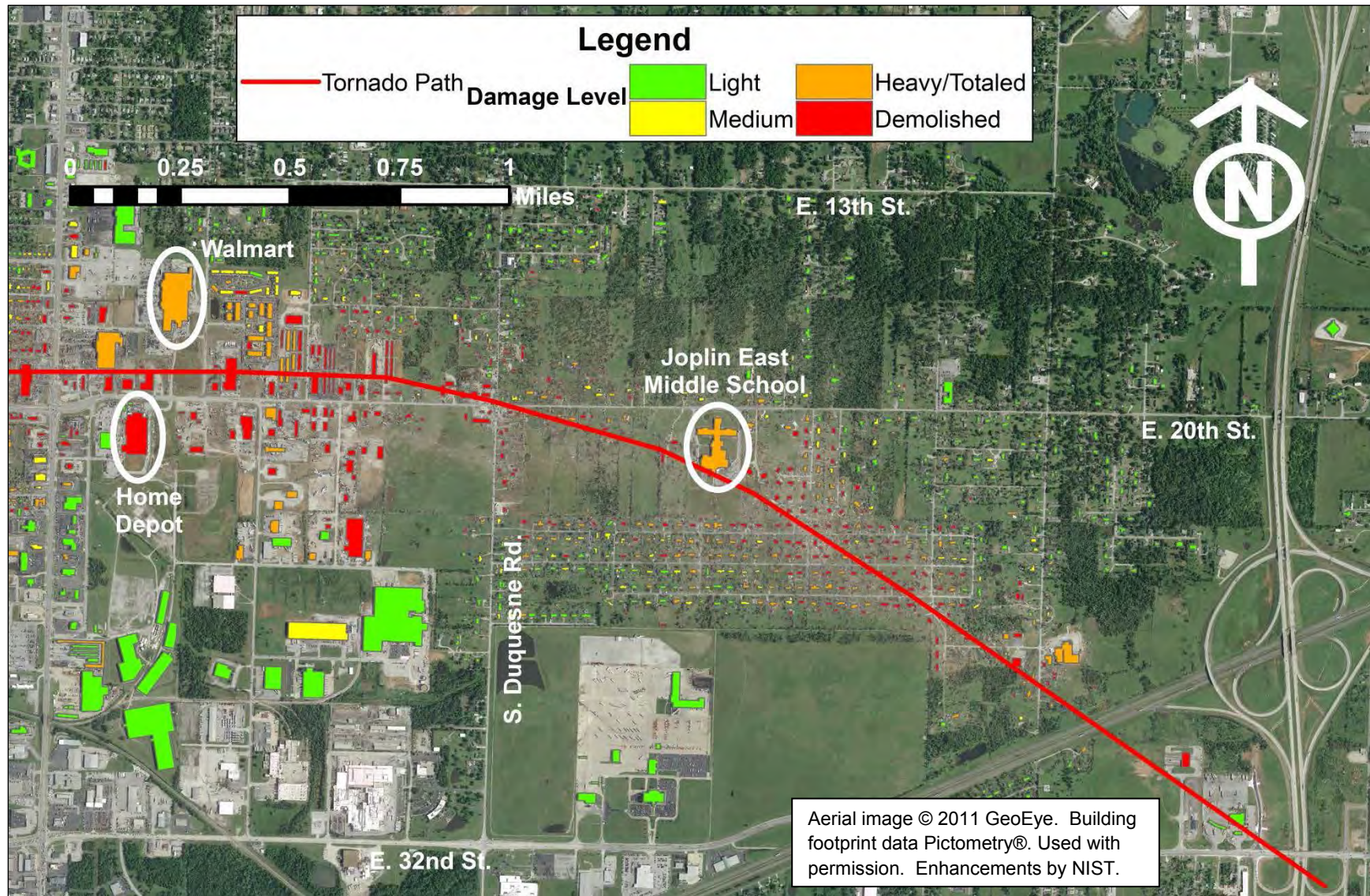

Figure 3–3. Easternmost segment of the tornado path through Joplin, showing locations of facilities surveyed by NIST relative to the estimated center line of the tornado damage path (red solid line). The color coded building footprints indicate the estimated level of damage to individual structures (see legend above).

- Section 3.4 describes the effects of the tornado on lifeline systems that pertain to operation of buildings in the tornado-affected area.
- Section 3.5 lists references cited throughout the chapter

3.1.3 Methodology for Building Performance Evaluation

The building performance issues resulting from this tornado are broad in scope, involving many types of construction of varying ages, and building designs that are based on successive versions of local building codes dating back to the 1960s. These different types of construction, while not designed for tornadoes, especially the extreme hazards associated with the May 22, 2011, Joplin tornado, performed very differently and sustained significantly different effects in this event.

Given the variety of structural systems involved, the varying availability of design information, and the different levels of building performance observed (both in terms of structural integrity and functionality), NIST adopted the methodology described below for evaluating the performance of building and lifeline systems in this tornado. The aims were (a) to address issues that pertain to whether the structures were designed and constructed in accordance with the applicable building codes, and whether code-level design wind loads would have caused the failures observed in some of the structures surveyed by NIST; and (b) to identify construction practices that lead to better performance in tornadoes or practices that can be improved for the same purpose.

- For engineered buildings that sustained structural collapse and for which NIST has complete design information:
 - Use the design information (including design parameters, building dimensions, and applicable building codes) to re-create the code-level design wind pressure for the building.
 - Use NIST's estimation of the wind environment to establish the tornado hazards affecting the structure.
 - Study the observed failures and compute the loads required to cause such failures.
 - Compare the failure loads with the code-level pressure to determine if the building would have sustained the failures under code-level loading.
 - Identify the sequence of occurrences leading to the failures based on field observations and analysis of the strengths of different structural components.
 - Identify changes to design and construction codes and practices that can potentially lead to reduced building vulnerability and improved performance in tornadoes.
- For engineered buildings that sustained damage to the envelope but did not collapse:
 - Review any available design information and use data collected in the field as well as from third parties to develop an understanding of the structural systems of the building.

- Use NIST’s estimation of the wind environment to establish the tornado hazards affecting the structure.
- Use field–survey damage data and survivor interview information to explain the effects of the tornado on building performance, both in terms of physical damage and building functionality.
- Identify changes to design and construction codes and practices that can potentially lead to reduced vulnerability and improved performance.

3.1.4 Tornado Design: A National Perspective

In jurisdictions in the United States that adopt building codes, the majority of the designs of conventional buildings—except for *storm shelters*,⁷² *safe rooms*,⁷³ and the *safety–related structures, systems, and components*⁷⁴ of nuclear power plants—is governed by the provisions of one of the model building codes, such as the International Code Council’s (ICC) *International Building Code* (ICC 2012a) or *International Residential Code for One– and Two–Family Dwellings* (ICC 2012b), or the National Fire Protection Association’s (NFPA) *Building Construction and Safety Code* (NFPA 2012). These model codes typically adopt provisions of the American Society of Civil Engineers ASCE 7 standard (2010) for determining minimum loads associated with the hazards (e.g., flood, snow, seismic, wind) considered in structural design.

For the wind hazard, ASCE 7 specifies a basic wind speed for use in determining design wind loads on structures in and outside of hurricane–prone regions. ASCE 7 allows the use of regional climatic data for estimating the basic wind speeds used in design in lieu of the ASCE–specified values as long as the data and data–analysis procedures meet certain statistical requirements. Although the commentary to the current ASCE 7 standard provides a tornado hazard map for the contiguous United States (developed in the 1980’s and based on a 10^{-5} annual exceedance probability), neither ASCE 7 nor the model building codes specify tornadoes as a design condition for conventional buildings, or require conventional buildings in tornado–prone regions to have occupant shelters at present. Thus, even though the requirements for wind–resistant design have been revised through regular updates to the model codes and ASCE 7 standard over the years (see summary of most significant changes pertaining to wind design in Table 3–3), neither the main wind–force resisting system (MWFRS) nor the components and cladding (C&C) of conventional buildings that have been designed to today’s minimum code requirements for wind hazard are expected to withstand the combined hazards of extreme wind speeds and wind–borne debris impact associated with strong tornadoes.

For *safety–related structures, systems, and components of nuclear power plants*, tornadoes are explicitly specified as a design condition. The U.S. Nuclear Regulatory Commission (NRC)/Regulatory Guide (RG)⁷⁵ 1.76 (1974), *Design Basis Tornado and Tornado Missiles for Nuclear Power Plants*, defined design–basis tornadoes as events with an annual exceedance probability of 10^{-7} (a return period of 10 million years) and prescribed tornado design parameters that include wind speed, pressure drop, and

⁷² Structures, either enclosed or partially enclosed in a host building, designed to the ICC 500 Standard.

⁷³ All stand-alone and internal structures designed to the FEMA 320 and FEMA 361 criteria.

⁷⁴ As defined by U.S. Nuclear Regulatory Commission/Regulatory Guide 1.117, *Tornado Design Classification*.

⁷⁵ NRC/RGs are NRC-issued, non-mandatory guides that describe methods and information considered acceptable to the NRC.

Table 3–3. Summary of significant changes in codes and standards pertaining to wind design.

Codes/Standards	Changes Pertaining to Wind Resistance Design
SBC (1982) UBC (1982) BOCA NBC (1987)	<ul style="list-style-type: none"> • Increased required uplift loads at roof perimeter and corners.
ASCE 7 (1995) IBC (2000)	<ul style="list-style-type: none"> • Used 3 second gust speed instead of fastest mile for basic design wind speed. Revised basic wind speed map from 70 mph fastest mile (approximately 85 mph in 3 second gust speed) to 90 mph 3 second gust for most non-hurricane-prone regions (resulting in increased basic design wind speed)⁷⁶. • Included provisions for torsional loading effect on buildings with mean roof height \geq 60 ft. • Increased internal pressure coefficients for partially enclosed buildings and buildings in hurricane-prone regions.
ASCE 7 (1998) IBC (2000)	<ul style="list-style-type: none"> • Updated basic design wind speed map from ASCE 7–95⁷⁷ • Added requirement for impact-resistant glazing or protection for glazing at heights less than 60 ft above ground for Category II, III, and IV buildings in wind-borne debris regions.
ASCE 7 (2002) IBC (2003)	<ul style="list-style-type: none"> • Included provisions for wind loads on parapets and rooftop equipment.
ASCE 7 (2010) ⁷⁸	<ul style="list-style-type: none"> • Changed load factor for wind load to 1.0 from 1.6. • Increased design wind speed for Performance Category II buildings to 115 mph (corresponding to an increase in wind velocity return period in the central US from 50 to 700 years). • Increased design wind speed for Performance Category III and IV buildings to 120 mph (increase in wind velocity return period in the central US from 100 to 1,700 years).

Key: ASCE, American Society of Civil Engineers; BOCA NBC, Building Officials and Code Administrators *National Building Code*; IBC, *International Building Code*; SBC, *Standard Building Code*; UBC, *Uniform Building Code*.

wind-borne missile load for three geographic regions. The American National Standards Institute (ANSI)/American Nuclear Society (ANS) Standard 2.3 (1983), *Standard for Estimating Tornado and Extreme Wind Characteristics at Nuclear Power Sites*,⁷⁹ provided similar design parameters, but for a range of annual exceedance probabilities between 10^{-5} and 10^{-7} . Both NRC/RG 1.76 and ANSI/ANS 2.3 prescribed maximum tornado wind speeds of 320 mph, 250 mph, and 180 mph (in fastest mile) for regions I, II, and III, respectively. The recently revised versions of these standards, NRC/RG 1.76 (2007) and ANSI/ANS 2.3 (2011), significantly reduced these tornado wind speeds, based on tornado probability

⁷⁶ This is the most significant change in ASCE 7-95. However, this change resulted in no net increase in design wind loads for most structural systems, except for overhang areas, since terrain and height factors, gust effect factors, and pressure coefficients were accordingly adjusted so that loads did not change.

⁷⁷ Based on new and more complete analysis of hurricane wind speeds which yields estimations of 50 and 100 year return period peak gust wind speeds along the coast. The new wind speed map includes the hurricane importance factor, which varies in magnitude and position along the coast and with distance inland, in the basic wind speed contours.

⁷⁸ The changes listed here represented no real net change in the design loads for buildings as the increase in design wind speeds is balanced by the reduction in load factor.

⁷⁹ A voluntary, consensus, industry standard, developed by the ANS and approved by ANSI.

studies described in NUREG/CR-4461 (Ramsdell and Rishel 2007) and in a report prepared at Lawrence Livermore National Laboratory (Boissonnade 2000), to 230 mph, 200 mph, and 160 mph for the three regions (see Fig. 3-4). In addition, the U.S. Department of Energy (DOE) Standard 1020 (2002), *Natural Phenomena Hazards Design and Evaluation Criteria for Department of Energy Facilities*, incorporates probability-based wind speeds similar to those in ANSI/ANS 2.3 (2011), but specifies the design tornado wind speeds for DOE's Performance Category 3 and 4 structures as speeds consistent with annual exceedance probabilities of 2×10^{-5} and 2×10^{-6} (50,000-year and 500,000-year return periods), respectively.

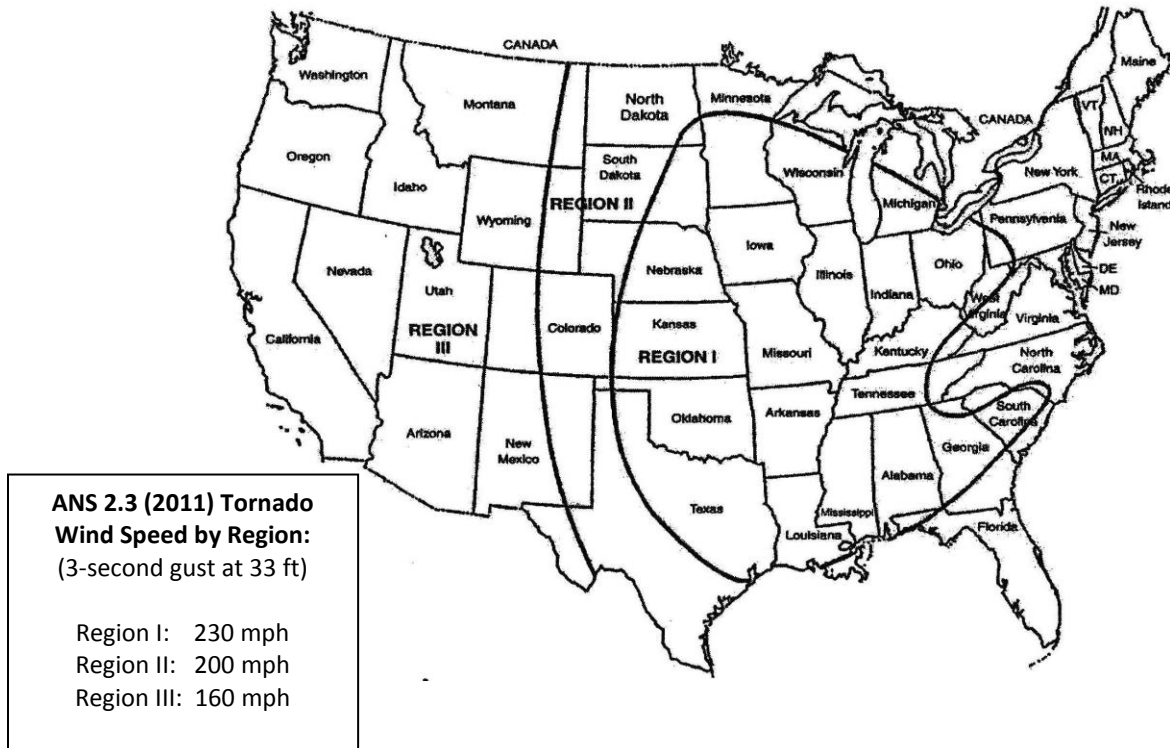

Source: Extracted from American National Standard ANSI/ANS-2.3-2011 with permission of the publisher the American Nuclear Society.

Figure 3-4. Regionalization of tornado wind hazard

Similar to *safety-related structures, systems, and components of nuclear power plants*, the design of *tornado shelters* and *safe rooms* also requires explicit consideration of the effects of tornadoes. The ICC/National Storm Shelter Association 500 *Standard for the Design and Construction of Storm Shelters* (ICC/NSSA 2008) prescribes the minimum design wind and missile speeds for the design of ICC storm shelters. FEMA 320 (2008a), *Taking Shelter from the Storm: Building a Safe Room for Your Home or Small Business*, and FEMA 361 (2008b), *Design and Construction Guidance for Community Safe Rooms*, also provide design requirements and construction guidance for FEMA safe rooms. Both the ICC 500 standard and the FEMA guides prescribe the same tornado hazard map showing four wind speed zones for the contiguous United States with maximum tornado wind speeds of 250 mph, 200 mph, 160 mph, and 130 mph (see Fig. 3-5). The wind speed zones in the FEMA guides and ICC 500 were developed



Source: FEMA (2008).

Figure 3–5. Tornado hazard map for shelter and safe-room design.

using tornado data recorded over the 1950–2006 period. It should be noted that there are differences in both the regionalization and the wind speeds between the nuclear-related standards (NRC/RG 1.76 (2007), ANSI/ANS 2.3 (2011), and DOE 1020 (2002)) and the standards/design guides for storm shelters and safe rooms (ICC 500 (2008), FEMA 320 (2008), and FEMA 361 (2008)), as shown in Fig. 3–4 and 3–5. These differences highlight the inconsistency in methodologies for tornado hazard characterization. Additional guidance for improving the tornado-resistant design of critical facilities, hospitals, and schools is provided in FEMA 543 (2007a), FEMA 577 (2007b), and FEMA P–424 (2010), respectively.

3.1.5 History of Building Code Adoption in Joplin

Although the State of Missouri does not presently have an adopted statewide building code, the City of Joplin, one of the State’s municipalities, has had a long history of code adoptions, with records dating back to 1877 (see Appendix G). Table 3–4 summarizes the building codes and amendments relevant to wind design that have been adopted by the City of Joplin since the 1960s. As shown, prior to the May 22, 2011, Joplin tornado, the most significant adoption of building codes by the City of Joplin took place in May 2008, through Ordinance No. 2008–068 (City of Joplin 2008), which adopted the 2006 ICC *International Building Code* (IBC), including Appendix Chapters C, F, G, I, and J, and the 2006 ICC *International Residential Code for One- and Two-Family Dwellings* (IRC), including Appendix Chapters A, B, C, D, G, H, I, J, M, N, and Q, with amendments (30 lb/ft² as the design snow load for roofs).

Table 3–4. History of code adoptions and amendments relevant to wind design by the City of Joplin, Missouri.

Code Adopted (Date)	Relevant Amendments	Required Increased Wind Loads for Critical Facilities or Increased Resistance for Residential Structures
1960 BOCA BBC (7/1961)		Yes
1965 BOCA BBC (10/1966)		Yes
1970 BOCA BBC (3/1970)		Yes
1978 BOCA BBC (5/1980)		Yes
1984 BOCA B/NBC (7/1984)		Yes
1990 BOCA NBC (11/1990)	Ord. 93–6 (snow and wind loads)	Yes
1996 BOCA NBC (7/1997)		Yes
2000 IBC, IRC (3/2003)		Yes
2006 IBC, IRC (5/2008)	Ord. 2008–068 (snow and wind loads, roofing and exterior finish materials) Ord. 2011–142 (residential foundation anchorage spacing, truss to wall connection, uplift resistance)	Yes

Key: BOCA BBC, Building Officials and Code Administrators *Basic Building Code*; BOCA NBC, Building Officials and Code Administrators *National Building Code*; BOCA B/NBC, Building Officials and Code Administrators *Basic/National Building Code*; IBC, *International Building Code*; IRC, *International Residential Code*; Ord., Ordinance.

Three months after the May 22, 2011 Joplin tornado, the City of Joplin considered Council Bill 2011–024 in response to issues related to the construction and performance of single- and two-family residential structures observed during the May 22, 2011, Joplin tornado. This bill was passed as Ordinance 2011–142 in November 2011 (City of Joplin 2011), which amended provisions of the 2006 IRC (adopted by the City of Joplin in May 2008, see Table 3–4) in the following areas:

- Required anchor bolts for residential foundation anchorage to be spaced not more than 4 ft on center (from 6 ft as specified in Sec. R403.1.6 of the 2006 IRC)
- Required *every* truss to be connected to wall plates by approved connectors having a resistance to uplift of not less than 175 pounds (779 N) (this amendment was more a clarification of than a change to 2006 IRC Sec. R802.10.5)
- Required *every* rafter to be connected to a supporting wall assembly by approved connectors (2006 IRC Sec. R802.11.1 required this only for rafters of roof assemblies subjected to wind uplift pressures of 20 lb/ft² (960 Pa) or greater, not for *every* rafter)

- Required *every* masonry foundation wall to have at least one #4 reinforcing bar, spaced no more than 4 in. on center, as anchors in the supporting footing under the masonry wall, and required the masonry block cells that contain the reinforcing bar to be filled with concrete, regardless of the unbalanced backfill height (Sec. R404.1.1 of the 2006 IRC specified anchor bolt spacing for masonry foundation walls based on maximum wall height and maximum unbalanced backfill height)

At the time of the May 22, 2011, Joplin tornado, and as is currently the case for many municipalities in tornado-prone areas of the Midwest, the City of Joplin encouraged, but did not mandate, the construction of safe rooms in residential (single-family homes and apartments) and commercial buildings.

3.2 PERFORMANCE OF BUILDINGS

Although conventional buildings are currently not required to be designed for tornadoes, understanding how tornado hazards affect and damage buildings that are code-compliant enables evaluation of the effectiveness of the tornado resistance of different construction types and building codes, which can result in improved future design requirements, more tornado-resilient construction techniques, and ultimately improved safety for building occupants. Such understanding can be achieved by studying the performance of buildings impacted by tornadoes, through documentation and analysis of the damage they sustained and by correlating this observed damage with estimations of the environmental conditions (i.e., wind speeds and EF-scale ratings, which are discussed in Chapter 2) they were subjected to during the tornado.

Most buildings in the area affected by the May 22, 2011, Joplin tornado were subjected to wind speeds (estimated in Chapter 2) that well exceeded the non-tornadic wind design requirements of the building codes applicable to them and impacts from wind-borne debris. The buildings that were surveyed by the NIST Team also experienced beyond-code loading conditions and represented typical construction types found throughout the United States. These types include steel moment resisting frame (SF), steel braced frame, concrete moment resisting frame (CF), concrete shear wall, BTS with CMU wall, BTS with precast concrete tilt-up wall, light steel frame, unreinforced brick, and wood frame. The types of damage they sustained are also representative of the damage observed for buildings of similar construction types in the affected area. Because of the differences in their functions, which entail different design requirements and performance expectations, the NIST-surveyed buildings were grouped into the following three categories for the performance reviews and damage summaries provided in this chapter:

- **Critical Facilities and High–Occupancy Buildings** (Sec. 3.2.1): These are engineered structures with a designated Risk (or Performance or Occupancy) Category of either III or IV for structural design purposes (ASCE/SEI 7–10; 2009 IBC; 2009 ICC Performance Code). The critical facilities in this section are buildings with Risk Category IV designations (referred to as *essential facilities* in the above references and defined as “*buildings and other structures that are intended to remain operational in the event of extreme environmental loading from flood, wind, snow, or earthquakes*”). They include buildings in SJRMC as well as Joplin Fire Station #4 and the Duquesne Police Station. The high-occupancy buildings in this section have Risk Category III designations; they include Joplin High School, Joplin East Middle School, Home Depot, Walmart, St. Mary’s Catholic Elementary School, and the Franklin Technology Center.

- **Commercial Buildings** (Sec. 3.2.2): The structures in this section are either engineered buildings or pre-engineered industrial-type buildings that can be classified under Risk (or Performance or Occupancy) Category II for structural design purposes (ASCE/SEI 7-10; 2009 IBC; 2009 ICC Performance Code). They include the Ozark Center for Autism, the William Meredith Center, the Ramesh Shaw Center, and St. Paul's United Methodist Church.
- **Residential Buildings** (Sec. 3.2.3): This section focuses on both multi- and single-family dwellings, typically of wood frame construction. Of the approximately 7,400 residential buildings in the city of Joplin that were damaged by the tornado, about 43 percent were built before 1950, and more than 82 percent were built prior to 1980. Depending on their proximity to the tornado center line, these residential buildings sustained damage ranging from light to total demolition.

3.2.1 Critical Facilities and High-Occupancy Buildings

3.2.1.1 St. John's Regional Medical Center

Overview—

SJRMCM was located just south of the tornado track, with its northernmost edge approximately 300 ft from the estimated center line of the May 22, 2011, Joplin tornado. The medical center comprised two separate building complexes aligned in a north-south direction perpendicular to the tornado track (see Figure 3-6).

The north complex included five buildings: the West Tower (building #1 on Fig. 3-6); the East (Patient) Tower (building #2); the Emergency Generator Building (building #3); the Chiller Plant (building #4); and the Oncology Clinic building (building #5). These buildings had different structural systems and were constructed at different times. The West Tower was the hospital's original building, constructed in 1965 in the first phase of construction. The East Tower and Oncology Clinic were subsequently added in 1982 in the second construction phase. The East and West Towers were the tallest buildings in the immediate area. The towers and the Oncology building were linked by three-story concrete frame sections, which were added in the third construction phase in 1990 and formed a common base joining most buildings of the north complex. These sections were designed based on the Building Officials and Code Administrators (BOCA) *Basic/National Building Code* (B/NBC) of 1984.

The south complex included three buildings: Medical Office Building (MOB) 1 (building #6 on Figure 3-6), MOB 2 (building #7), and the Physician's Office Building (building #8). Each of these buildings was an independent steel-frame structure.

The SJRMCM buildings were color-coded on Figure 3-6 based on damage estimates by Pictometry[®] which showed the Emergency Generator Building as being *demolished* by the tornado and all other SJRMCM buildings as having sustained *medium* damage. The Pictometry[®] database was one of three damage

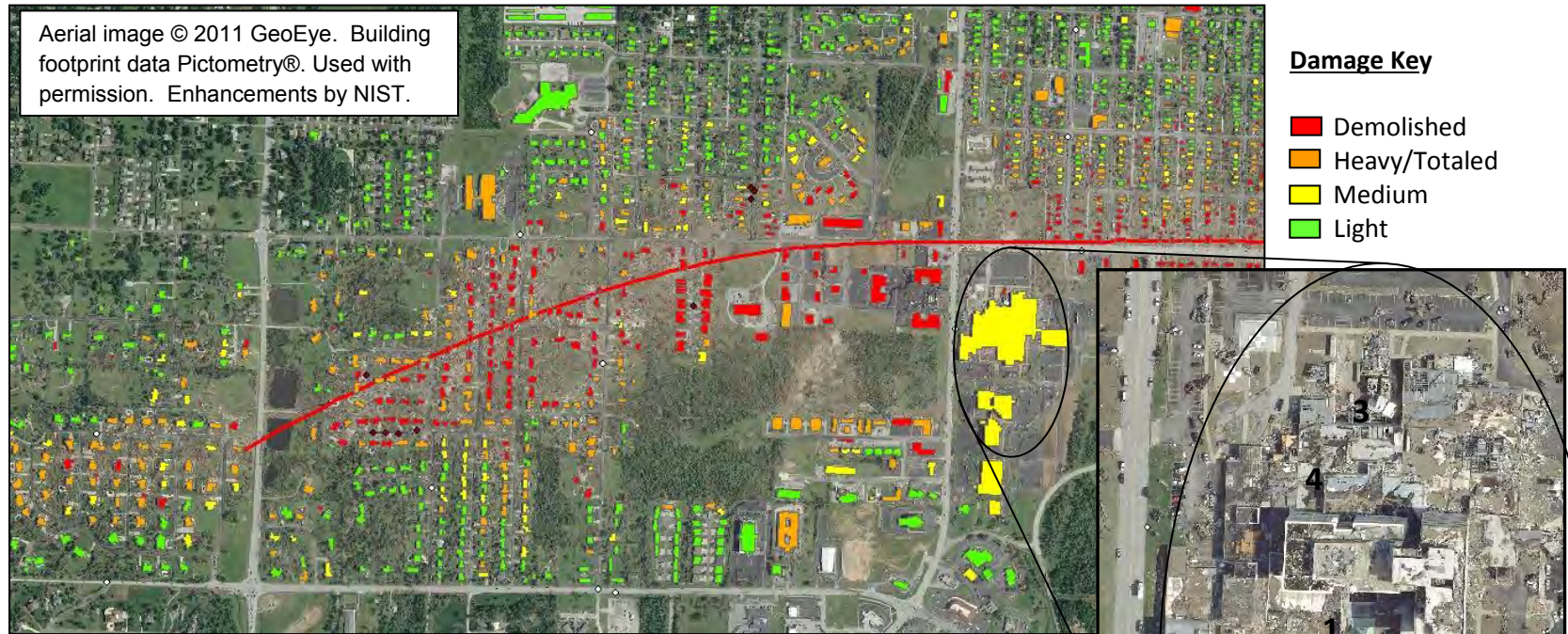
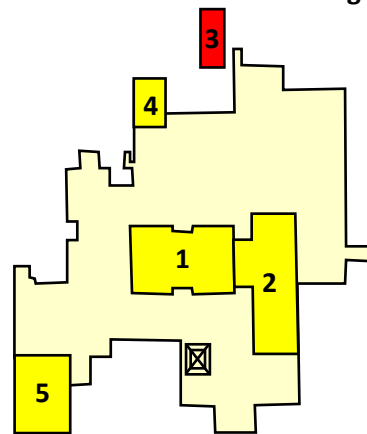

Figure 3–6. Overview of St. John’s Regional Medical Center.

Key Plan

- (1) West Tower
- (2) East Tower
- (3) Emergency Generator Bldg
- (4) Chiller Plant
- (5) Oncology Clinic Building
- (6) Medical Office Building 1
- (7) Medical Office Building 2
- (8) Physician Office Building 3



SJRMC North Complex

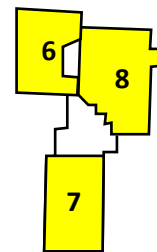

SJRMC South Complex

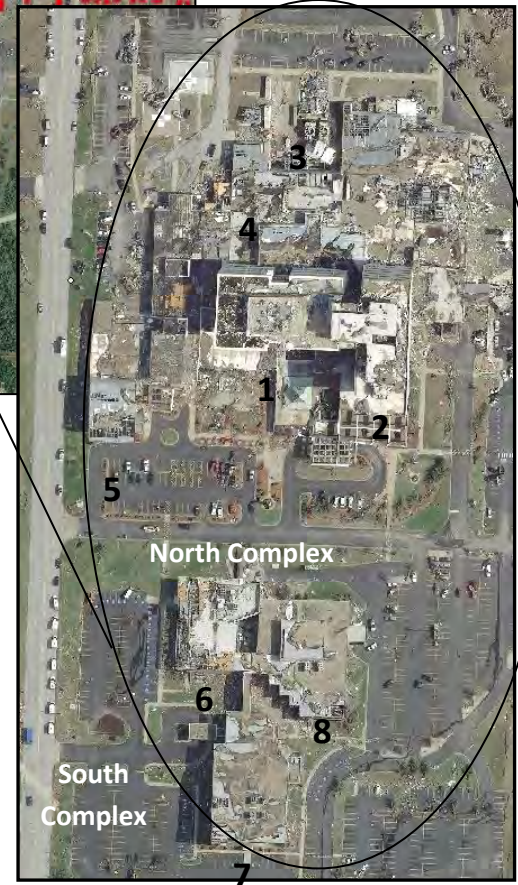

databases obtained by NIST (the others created by the U.S. Army Corps of Engineers and the SAVE⁸⁰ Coalition). SJRMC was situated immediately to the east of a mixed commercial and residential area in which the majority of buildings were demolished by the tornado (EF-4 damage based on NIST's evaluation). Thus, it was directly downstream of the debris field that resulted from the damage to buildings in this area.

Figures 3-7 and 3-8 show the time histories of wind speed and wind direction estimated for locations close to the north and south complexes of SJRMC. These figures indicate that buildings in the north complex, which were closer to the center line of the tornado damage path, experienced stronger winds than did buildings in the south complex. The maximum wind speed that affected buildings in the north complex was estimated to be about 170 mph \pm 20 mph (EF-4 range, from a westerly direction), and the maximum wind speed affecting the south complex buildings was estimated to be about 120 mph \pm 20 mph (EF-2 to EF-3 range, from a south-westerly direction). Given SJRMC's functionality as a critical facility that should remain operational, current building code would have designated its buildings as Risk Category IV structures for design purposes, meaning that they would have been designed for a basic wind speed of 120 mph based on today's design standards.

The tornado caused 14 fatalities at SJRMC (5 on the day of the tornado, 4 who were Intensive Care Unit (ICU) patients on respirators and 1 who was on the 3rd floor, plus 9 who were injured that day and died later—see Chapter 4). At the time the tornado struck, there were reportedly 183 patients at the hospital. Most of these patients (except those in the ICU) were moved to the hallway areas on each floor of the buildings following the tornado warnings, according to SJRMC's staff.

NIST received a significant amount of information on the design and construction of, and the damage sustained by, buildings at SJRMC from the Joplin Public Works Department, Sisters of Mercy (parent organization of SJRMC), and architectural and engineering design firms contracted by Sisters of Mercy. However, despite timely and full cooperation from all of these organizations, NIST was only able to obtain partial drawing sets for the SJRMC buildings. This is due primarily to the loss of records due to the passage of time (the first building was designed in 1965). The following important documents and materials have not yet been located for SJRMC buildings:

- Structural drawings and specifications and as-built drawings for most buildings and additions at SJRMC, including the West Tower.
- Drawings and specifications for renovations that involved the modification or replacement of windows, particularly the 1969 renovations to the Behavioral Health Unit on the fifth floor of the West Tower. The windows in this unit are believed to have been breakage resistant and appeared to sustain much less damage compared with other windows at SJRMC.

Information about the performance of individual buildings at SJRMC during the May 22, 2011, Joplin tornado—developed based on damage observations, estimation of the environmental conditions that affected the buildings, and available design information—is summarized below.

⁸⁰ Structural Assessment and Visual Evaluation, a volunteer organization of engineers that conducted building evaluations in Joplin, MO following the May 22, 2011, Joplin tornado.

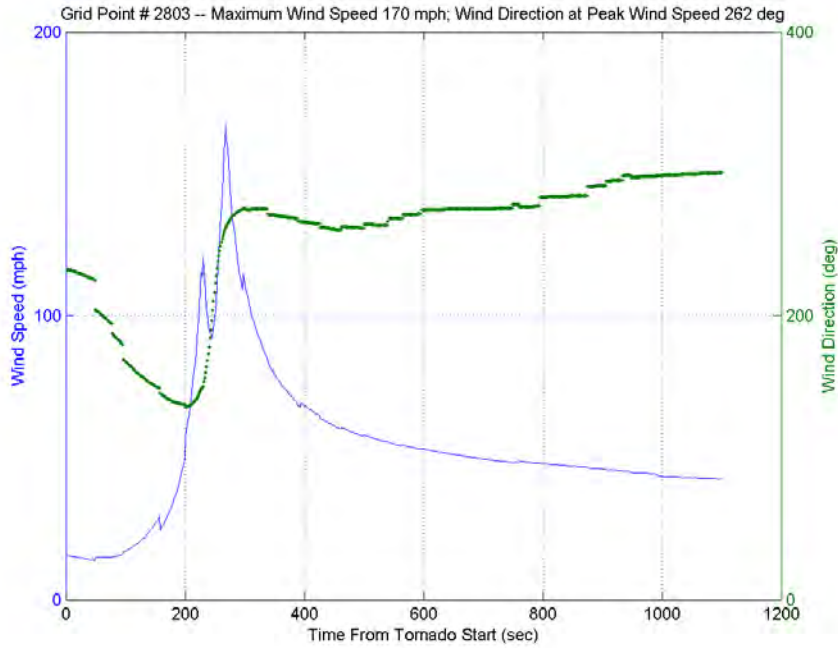

Figure 3-7. Time-history of wind speed and direction at north end of SJRMC.

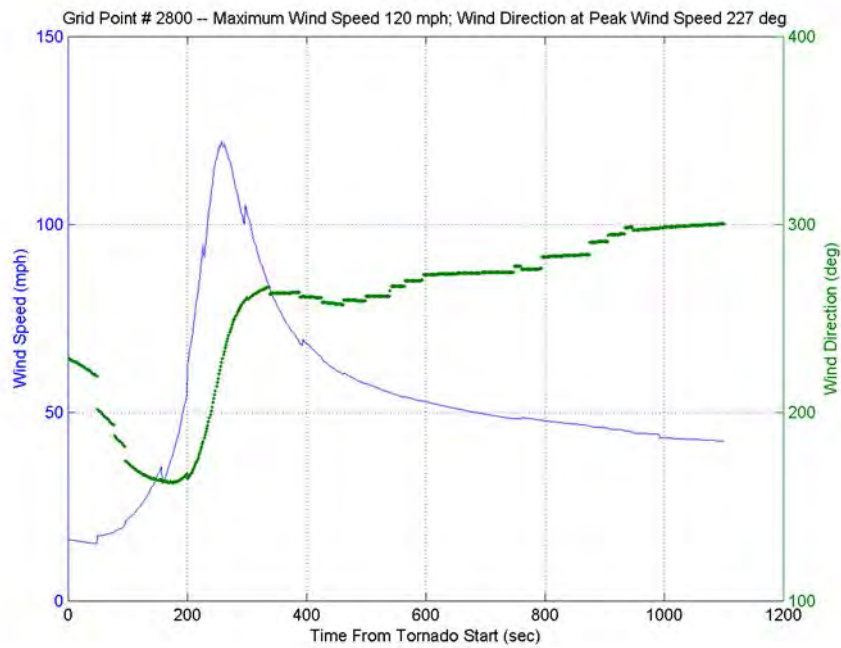

Figure 3-8. Time-history of wind speed and direction at south end of SJRMC.

West Tower—

Figure 3–9 shows the north-facing side of this building. Following is information about the design of the building and its performance in the tornado.



Figure 3–9. SJRMC's West Tower (north side).

Design Information:

- Year Built: 1965.
- Building Code: Actual design information was not available. The design was likely based on the 1960 BOCA BBC given the year of construction and the adoption of this code by the City of Joplin in July 1961 (see Appendix G).
- Design Wind Speed: Actual design information was not available; likely 70 mph (in fastest mile, or about 85 mph in 3 second gusts) given the year of construction and the building code then in effect.
- MWFRS: Seven-story, cast-in-place reinforced concrete (RC) frame, with a mean roof height of 86.7 ft.
- Floor System: RC waffle slab floor.
- Components and Cladding:
 - Envelope: Except for the fifth floor, which housed the Behavioral Health Unit and had breakage-resistant glass windows, the rest of the West Tower's envelope consisted predominantly of single-story curtain wall panels made of aluminum framing with either

- (a) dual-pane insulated glass windows (with inner and outer panes separated by a space filled with inert gas) or (b) aluminum panels, and a smaller area with brick curtain walls.
- Roof Assembly: Concrete slab covered by (a) single-layer rigid insulation, (b) single-ply, loose-laid ethylene propylene diene monomer (EPDM) membrane, and (c) aggregate ballast (smooth gravel with a maximum size slightly larger than a golf ball).
- Other Features: Two-story penthouse elevator machine rooms. The first story of the penthouse (considered the 8th floor of the building), which was accessible by elevator, had a cast-in-place RC frame. The second story, accessible by stairs from the first story of the penthouse, had a steel frame.

Damage and Performance Information:

- There was no structural damage to either the lateral load system (RC frame MWFRS) or the gravity load system (RC waffle floor slabs).
- The building envelope sustained significant damage, including:
 - Breakage of almost all (up to 80 percent of) vertical glass windows (both panes) and damage to vertical aluminum window mullions on all three wind-exposed sides of the tower (north, south, and west), except for the breakage-resistant glass windows on the fifth floor (see Fig. 3-10 and 3-11). While there was evidence of window breakage by small projectiles (general wind-borne debris, including roof gravel, found in building interior), the overall damage to the windows was likely caused by both wind overpressure and the impact of wind-borne debris. Breaches in the building envelope allowed strong wind, water, and wind-borne debris to infiltrate and subsequently cause significant damage to the interior of the building (see below).
 - Breakage of some brick curtain walls.
 - Collapse of the unreinforced CMU penthouse's curtain walls that protected the elevator machine rooms (see Fig. 3-12).
 - Loss of aggregate ballast from the roof and subsequent peeling-off of the EPDM roofing membrane and rigid insulation (also see Fig. 3-12). Note that the current IBC (2012) prohibits the use of aggregate as roof ballast for buildings in hurricane-prone regions and buildings with mean roof heights exceeding certain heights depending on the required basic wind speed and exposure category (see 2012 IBC Sec. 1504.8). In Joplin (90 mph basic wind speed and exposure category B), aggregate roof ballast would be prohibited for buildings with mean roof heights exceeding 110 ft. Thus, the West Tower, with a mean roof height of 86.7 ft, would be in compliance with this current IBC roof aggregate requirement.

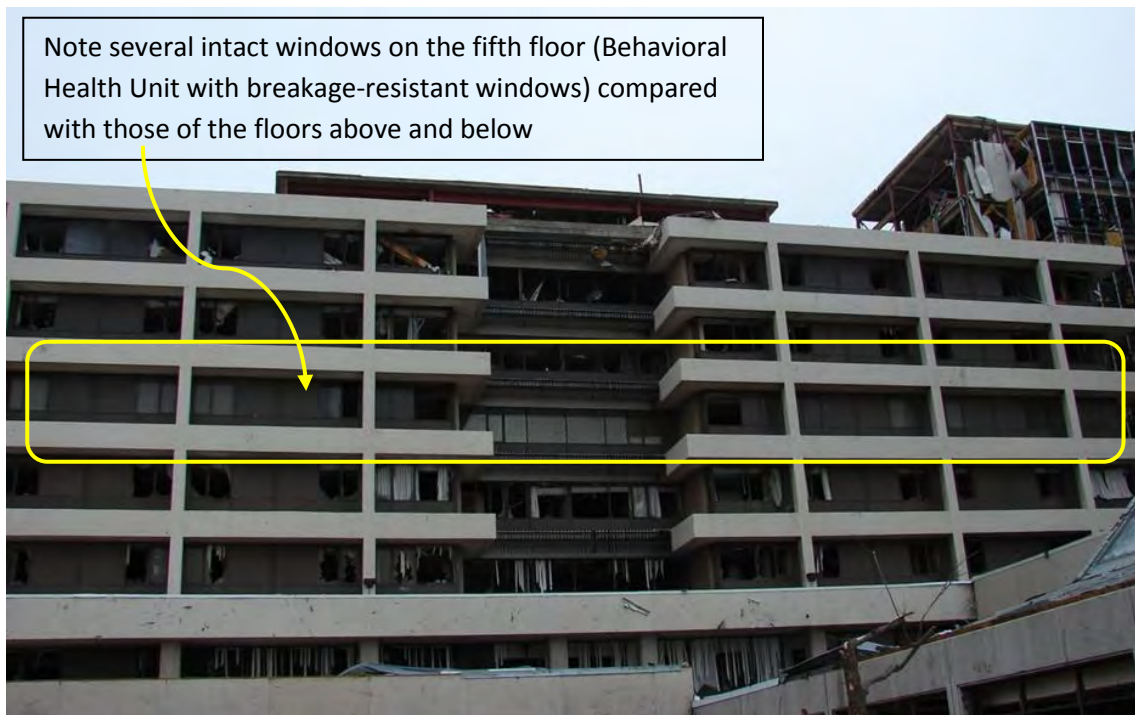

Figure 3–10. Intact windows on fifth floor of West Tower (south side).



Figure 3–11. Intact windows on fifth floor of West Tower (north side).

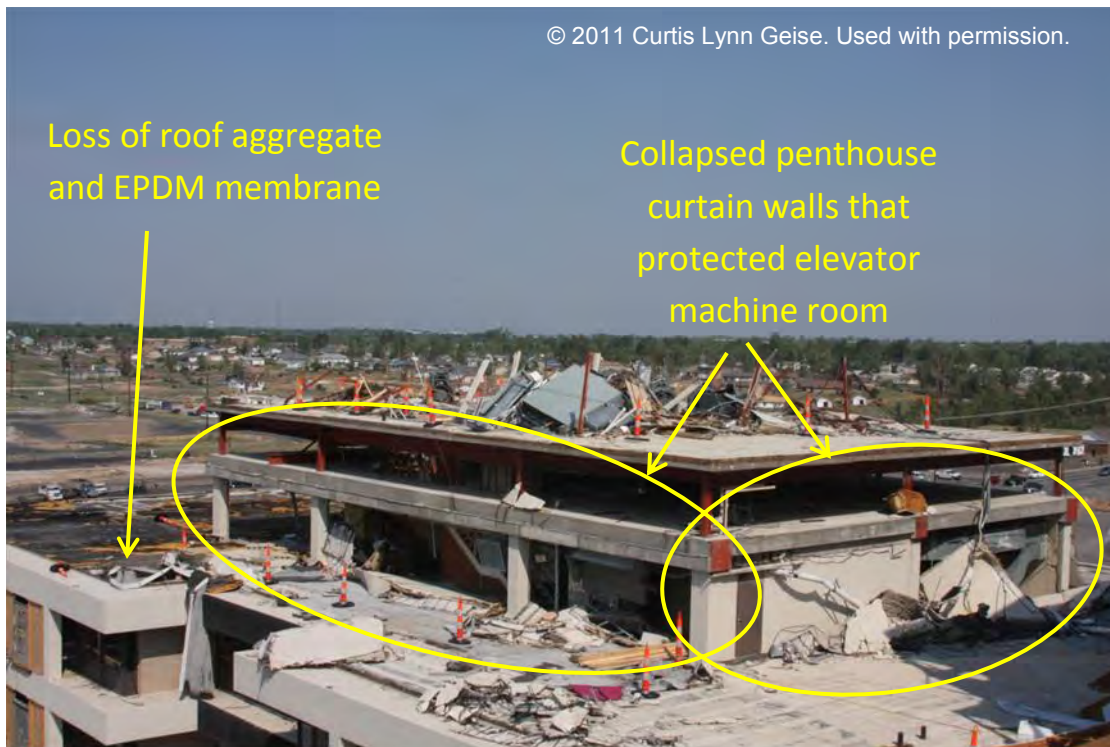

Figure 3–12. Damage to roof and penthouse walls of West Tower.

- There was significant damage to the building interior, including:
 - Breakage or collapse of interior partitions, suspended ceiling systems (hanging grid and lay-in ceiling tiles), furniture, electrical fixtures and wiring, HVAC ductwork and equipment, and other general building contents (see Fig. 3–13); and
 - Infiltration of water and debris, and dislodging of building hazardous materials (asbestos on flooring material) (FM Global 2011).
- Even if electrical power had not been lost (see “Emergency Generator Building” below), the damage to the building envelope and interior would have resulted in the complete loss of functionality that occurred in this building. This is because even though there was no damage to the structural system, there was a complete loss of control over the interior environment (loss of temperature and moisture control due to the breached envelope and damage to HVAC equipment and ductwork), over illumination (broken electrical fixtures and wiring), and over mechanical vertical movement (damage to the elevator shaft gypsum-wall enclosure and elevator machine rooms). In addition, interviews of survivors conducted by NIST revealed that the damage to the building envelope and interior also presented the building occupants with significant hazards such as tripping, slipping, and electrocution (broken power lines and electrical fixtures that might have been energized if backup power had been switched



Figure 3–13. Typical damage to the interior of West Tower.

automatically) hazards as they tried to evacuate the building in total darkness. Below are relevant excerpts from the interview transcripts compiled by NIST:

“You know what was scary is we were still ankle–deep in water; it was just pouring down like a sieve. The water around our ankles just never went anywhere. It was ankle–deep, and it was sparks over our head, and everybody was worried”. (NIST Interview 2)

“Most of us had abrasions and cuts and that sort of thing but no one expired and it’s an absolute miracle. Mostly because the fourth wall in from the outside, from the south part of the hospital stayed up. So the exterior window walls came in, the inside patient room walls came in and another interior wall came down part way and the fourth wall stayed up and that sort of sheltered the interior hallway where we were”. (NIST Interview 6)

“And so that was really, really the most difficult thing about that was getting people out once we got them uncovered because there was debris on top of people, on top of us, walls in, doors in, door frames in, debris everywhere. You can’t imagine the shattering that goes on when you have materials exposed to that kind of wind. Plus just the wires that were down from the ceiling, all the equipment that’s inside a room,

debris a foot, two–feet deep some places that you had to move before you could get somebody out. And then you had a couple of people who had walls on top of them, meaning leaning over them, they were compressed under them. Some people—two of them were underneath one of those two–inch or inch–and–a–half water mains that I told you about for fire suppression. It was falling right on them; they were gonna be hypothermic pretty quickly so we had to move them. One of those was trapped and it took me probably 15 minutes, 10 minutes, to get her loose”. (NIST Interview 6)

East (Patient) Tower—

The East Tower was connected to the West Tower along its entire elevation by a 10–story steel frame (SF) structure that housed the elevator shafts serving both towers. This connecting elevator tower was the tallest structure at SJRMC with a 126.8 ft mean roof height. Thus, even though they were independent structural systems, the two towers had common, connecting interior floor plans. NIST was able to obtain partial framing plans for this building, which showed that it was a steel moment frame structure, but no design information (building code, design wind speed). Figures 3–14, 3–15, and 3–16 show exterior views of this building. Information about the building’s design and damage is summarized below.

Design Information:

- Year Built: 1985.
- Building Code: Actual design information was not available. The design was likely based on the 1984 BOCA B/NBC given the year of construction and the adoption of this code by the City of Joplin in July 1981 (see Appendix G).
- Design Wind Speed: Actual design information was not available. The design wind speed was likely 70 mph (in fastest mile, or about 85 mph in 3 second gusts) given the time of construction and the building code then in effect.
- MWFRS: The East Tower building had a nine–story SF with moment connections and steel cross bracing (wind frame, in east–west direction), supported on individual RC spread footings with a 109.3 ft mean roof height (just under the 110 ft IBC limit for use of roof aggregate). The 10–story elevator tower’s mean roof height was 126.9 ft (above the 110 ft IBC limit for use of roof aggregate).
- Floor System: Composite concrete–steel deck floor (4½ in. thick semi–lightweight concrete slab reinforced with 6 × 6 W2.1 × W2.1 welded wire fabric on 2 in., 18–gauge (0.0474 in. thick) wide–rib galvanized steel deck).
- Components and Cladding:
 - Envelope: The East Tower building had a combination of single–story curtain wall panels made of aluminum framing and dual–pane insulated glass glazing and a precast concrete column–cover–and–spandrel–system. The 10–story elevator tower had a multi–story unit–and–mullion with dual–pane insulated glass curtain wall system.



Figure 3–14. View from southwest of East Tower showing that most windows on south and west sides of building and curtain walls on connecting elevator steel frame have broken.



Figure 3–15. View from southeast of East Tower showing that most windows on south and east sides of building have broken.

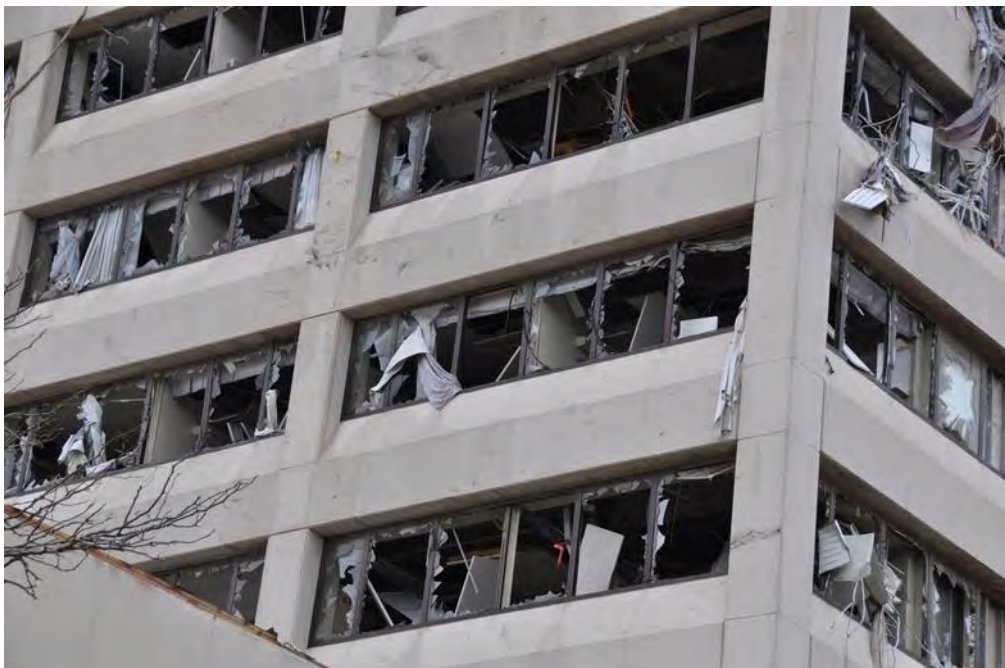

Figure 3–16. Close-up view showing minor damage to architectural precast concrete column–cover–and–spandrel system and significant damage to glass windows of East Tower.

- Roof: Concrete slab covered by single-layer rigid insulation and single-ply, loose-laid EPDM membrane with aggregate ballast (same as the West Tower).
- Other Features: The East Tower building included a one-story SF penthouse mechanical room, accessible by elevators, with vertical insulated metal curtain wall panel cladding.

Damage and Performance Information:

- There was no structural damage to either the lateral load systems (steel moment frame and braced frame MWFRS) or the gravity load systems (RC pan joist floor slabs) of the East Tower or the connecting elevator tower.
- There was significant damage to the building envelope, including:
 - Breakage, likely caused by both wind pressure and the impact of wind-borne debris based on site inspection, of almost all vertical dual-pane insulated glass windows on all wind-exposed sides of the East Tower and the glass curtain walls of the 10-story connecting elevator tower.
 - Loss or collapse of the penthouse’s vertical insulated metal curtain wall panels that protected the elevator machine/mechanical room (see Figure 3–17).

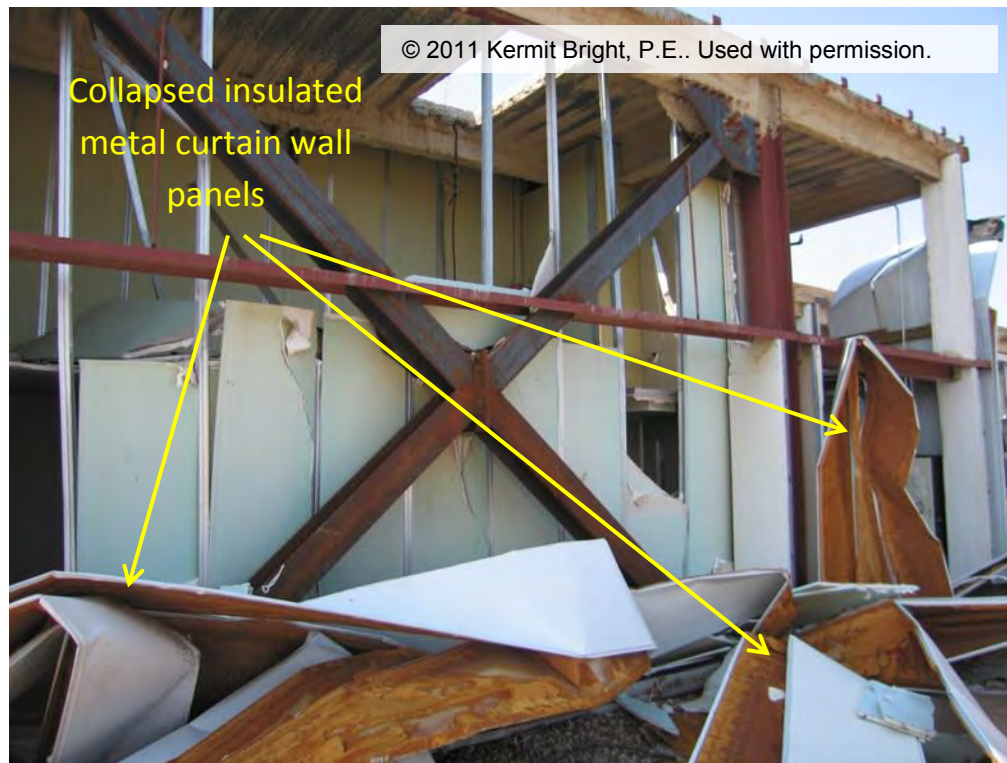

Figure 3–17. Missing/collapsed vertical insulated metal curtain wall panels of East Tower penthouse.

- Loss of aggregate ballast from the roof and subsequent peeling–off of the roof covering system (EPDM roofing membrane and rigid insulation, similar to the West Tower; see Figures 3–18 and 3–19). As noted for the West Tower, the nine–story East Tower, with its mean roof height of 109.4 ft (just under the IBC limit of 110 ft), was considered code–compliant for use of roof aggregate ballast. It is not known if aggregate was used as roof ballast for the taller 10–story elevator tower (126.9 ft mean roof height). Regardless of the code height limit, there was evidence that the roof aggregate did contribute to the damage sustained by the envelopes of adjacent buildings.
- There was significant damage to the interior of the East Tower and the connecting elevator tower, including damage to the elevator shaft wall.

Emergency Generator Building—

This structure was a one–story, above ground, rectangular (28 ft by 48 ft) BTS building with exterior CMU walls and a short–span metal roof diaphragm, constructed as part of the third construction phase (see Figures 3–20, 3–21, and 3–22). All other buildings at SJRMC had either steel or concrete frames; the Emergency Generator Building was the only BTS building at this facility.

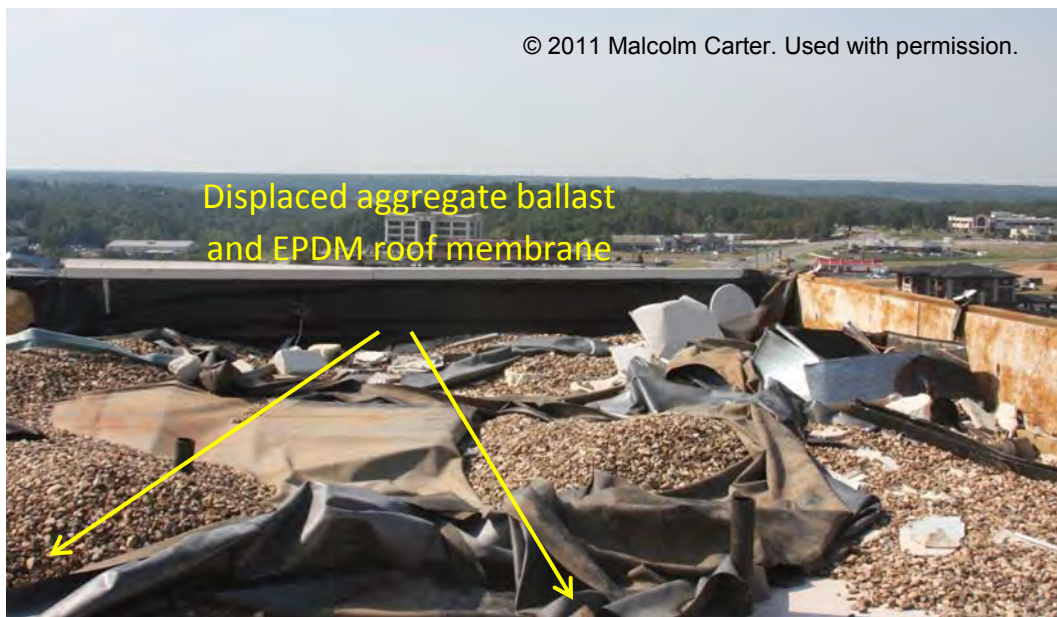

Figure 3–18. Damage to roof covering system of East Tower (peeling-off of EPDM roof membrane and rigid insulation, loss/displacement of roof aggregate ballast).

Design Information:

- Year Built: 1994.
- Building Code: BOCA National Building Code/1990.
- Design Wind Speed: 70 mph (in fastest mile, or about 85 mph in 3 second gusts).
- MWFRS: This was a one-story BTS building with a 14.5 ft mean roof height and partially grouted, lightly reinforced, single-wythe CMU exterior walls (12 in. wide blocks) on RC footings. The exterior CMU walls were laterally braced by a wide-rib steel roof deck diaphragm supported by single-span, open-web steel bar joists with ends anchored into the bond beam (top course of masonry) on top of the exterior CMU walls.
- Floor System: 5 in. thick RC slab-on-grade.
- Components and Cladding:
 - Envelope: 12 in. thick CMU walls with 1 in. thick rigid thermal insulation on the exterior of the walls.



Figure 3–19. Overview of West, East, and Elevator Towers and Oncology Clinic Building showing that most of the aggregates that were used as roof ballast on these buildings are missing.



Figure 3–20. View from northwest of Emergency Generator Building. Note northward and eastward direction of wall failure, consistent with the direction of maximum wind (westerly) shown on Figure 3–7.



Figure 3–21. East side of Emergency Generator Building. Note eastward direction of failure on east wall (CMU wall falling outward, door opened, louver pushed outward). Also note louver on north wall pushed outward, consistent with direction of maximum westerly wind and indicative of high internal pressure.



Figure 3–22. Failure details at Emergency Generator Building.

- Roof: Single-span, open-web steel bar joists (20K3) at 5 ft spacing, supporting a 1½ in. wide-rib metal roof deck that was covered by 2 in. thick rigid thermal insulation boards, a layer of single-ply EPDM roof membrane, and aggregate roof ballast.
- Other Features: None.

Damage and Performance Information:

- The building sustained total collapse, with damage typical of structural damage associated with BTS buildings in extreme wind hazards. The metal roof system (metal deck panels and steel bar joists), which provided lateral bracing for the exterior CMU walls, failed completely, likely due to wind uplift pressure. Observations made following the tornado found that roof deck panels had peeled off from the supporting steel roof trusses (tension failure of the puddle welds connecting the roof deck to the bar joists due to wind uplift) and the ends of the roof trusses that were anchored into the bond beams on top of the exterior walls had disconnected from the walls. All four exterior CMU walls (except for small portions of the south and east walls) collapsed. Figures 3–20 and 3–21 show views from the northwest and northeast corners of this building, respectively. Note that both the west and east walls of the building collapsed eastward, which was the translational direction of the tornado and also consistent with the wind direction estimated by wind field model (see Chapter 2). Also note that the door and louver on the east wall and the louver on the north wall were pushed outward, indicating high internal wind pressure acting on the walls of this building. Figure 3–22 shows the reinforcement of the bond beam and the disconnected anchor that formerly connected the end of the steel roof truss to the wall.
- The total collapse of this building destroyed all of the backup power generators that were housed within it, resulting in the loss of the emergency power supply for the entire SJRMC complex.

Chiller Plant—

The Chiller Plant was a one-story steel frame structure located at the northeast corner of the SJRMC's north complex. Being in close proximity to the Emergency Generator Building, it was likely subjected to similar wind and debris hazards that affected the Emergency Generator Building. Below is the design and performance information that pertains to the Chiller Plant.

Design Information:

- Year Built: 1985.
- Building Code: Actual design information was not available. The design was likely based on the 1984 BOCA B/NBC given the year of construction and the adoption of this code by the City of Joplin in July 1984 (see Appendix G).
- Design Wind Speed: Actual design information was not available. The design wind speed was likely 70 mph (in fastest mile, or about 85 mph in 3 second gusts) given the time of construction and the building code then in effect.

- MWFRS: Steel frame comprised of W–shape beams and columns that were joined by bolted connections. The columns were cast into the concrete foundation.
- Floor System: 5 in. thick RC slab.
- Components and Cladding:
 - Envelope: Three–layer exterior wall enclosures comprised of an inner layer of partially grouted CMU, a middle layer of extruded polystyrene insulation, and an outer layer of brick veneer.
 - Roof: 1½ in. wide–rib metal roof decks supported by W–shape longitudinal and transverse roof beams.
- Other Features: None.

Damage and Performance Information

- There was no structural damage to the lateral load resisting system (steel frame MWFRS).
- There was significant damage to the building envelope, including:
 - Loss of some of the roof deck panels and roof covering due to wind uplift (horizontal envelope).
 - Collapse of most of the west wall (directly facing the oncoming tornado), half of the north wall, and a smaller portion of the east wall. The south wall was not damaged (connected to an adjacent building and was not exposed to wind). These collapses were likely the result of debris impacts and lateral wind pressure as the stability of these walls did not depend on the lateral bracing by the roof.
- The damage to the building envelope resulted in the loss of mechanical equipment required for air conditioning (evaporator, condenser pumps, and chillers) that was housed inside the building, and ultimately the loss of air conditioning for the entire SJRMC even if electrical power had not been lost (see Fig. 3–23).

Oncology Clinic Building—

Design Information:

- Year Built: 1988.
- Building Code: BOCA National Building Code/1987.
- Design Wind Speed: Not specified. The design wind pressures were 22.3 lb/ft² (0 ft to 20 ft height) and 23.8 lb/ft² (20 ft to 40 ft height).
- MWFRS: The clinic building had a two–story SF with moment connections between primary members and a mean roof height of 30 ft 7½ in.



Figure 3–23. Views of damage sustained at the Chiller Plant.

- Floor System: Composite concrete–steel deck floor (4½ in. thick lightweight concrete slab with 6 × 6, W2 × W2 welded wire fabric on 2 in., 18–gauge (0.0474 in. thick) wide–rib galvanized steel deck).
- Components and Cladding:
 - Envelope: Single–story curtain wall windows made of aluminum framing with dual–pane insulated glass, and precast concrete architectural column and spandrel panels for exterior covers.

- Roof: 1½ in. × 6 in., 22-gauge (0.0295 in. thick) wide-rib galvanized steel roof deck, covered by 5/8 in. gypsum board, 2 in. thick rigid insulation, single-ply loose-laid EPDM roof membrane, and aggregate roof ballast. The steel roof deck was connected to the W12 × 19 wide-flange roof beams (typical) by puddle welds.

Damage and Performance Information:

- There was no structural damage to the lateral load system (steel moment frame MWFRS) or the gravity load floor system (composite RC-on-steel deck).
- The building envelope sustained significant damage, including:
 - Breakage of all insulated glass panels and the loss of window systems (glass and aluminum frame), likely caused by both wind pressure and the impact of wind-borne debris based on site inspection, on all wind-exposed sides of the building (see Fig. 3–24).
 - Loss of several panels of steel roof deck, roof aggregate, membrane, rigid insulation, and gypsum board (see Fig. 3–25 and 3–26).

The architectural precast column and spandrel covers cladding system sustained only minor damage.

- There was significant damage to the interior of the building, including:
 - Breakage or collapse of interior partitions, metal wall studs, suspended ceiling systems (hanging grid and lay-in ceiling tiles), furniture, fixtures, and equipment (electrical fixtures and wiring, HVAC ductwork, and general building contents) (see Figure 3–27).
 - Infiltration of water and debris (including roof aggregate), and dislodging of building hazardous materials.

Medical Office Buildings—

As indicated in Section 3.2.1.1 Overview, the SJRMC’s south complex comprised three independent steel-frame structures: Medical Office Building 1; Medical Office Building 2; and Physician’s Office Building that served as medical office buildings for the SJRMC (see buildings 6, 7, and 8, respectively, on Figure 3–6). Being farther south from the estimated tornado damage center line compared with SJRMC’s north complex buildings, these medical office buildings were subjected to less severe wind speeds, with estimated maximum wind speed of about 120 mph ± 20 mph (EF–2 to EF–3 range, from a southwesterly direction, see Fig. 3–8). Below the design and performance information that pertains to the medical office buildings.



Source: FEMA Mitigation Assessment Team (MAT)

Figure 3–24. South elevation of Oncology Clinic Building showing damage to building envelope (broken glass windows, missing window frame, missing roof decks).



Figure 3–25. Roof of Oncology Clinic Building: missing steel deck panels, gypsum board, rigid insulation, membrane, and aggregate ballast.

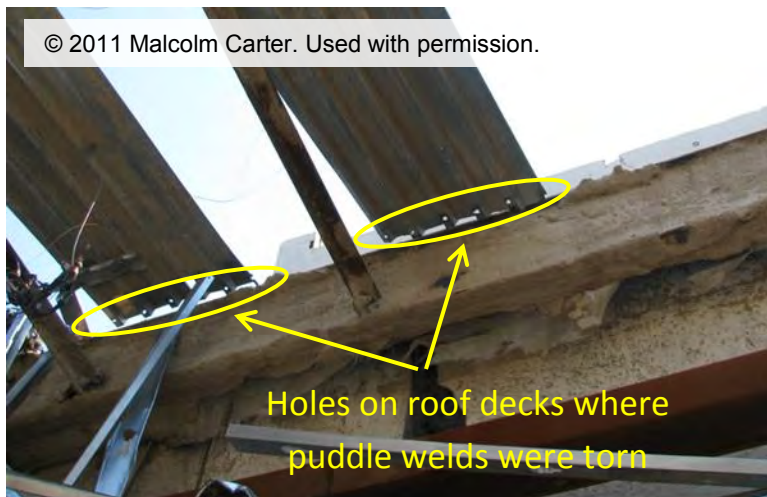

Figure 3–26. Roof of Oncology Clinic Building: failed puddle welds connecting roof deck with supporting roof beam.



Figure 3–27. In Oncology Clinic Building, interior damage to ductwork, electrical wiring, suspended ceiling, interior partition/metal stud wall, furniture. Note the aggregate from roof in the interior.

Medical Office Building 1

This was a two-story steel frame building on a concrete slab foundation. The design and damage information is described below.

Design Information:

- Year Built: Information was not available.
- Building Code: Information was not available.
- Design Wind Speed: Information was not available.
- MWFRS: Steel frame comprised of W-shape beams and columns that were joined by bolted connections. The columns were cast into the concrete foundation.
- Floor System: Composite concrete-steel deck floor (5 in. thick RC slab).
- Components and Cladding:
 - Envelope: Comprised of combination of four types of curtain walls: (1) single-story glass panels with aluminum framing; (2) brick veneer backed by aluminum stud frames; (3) architectural spandrel panels (made of light-gauge steel and aluminum channels and cement-based surface boards); and (4) two-story unit-and-mullion walls with glass glazing.
 - Roof: 1½ in. wide-rib steel roof decks supported by open-web steel roof joists.

Damage and Performance Information:

- There was no structural damage to the MWFRS (steel frame) or the gravity load floor system (composite RC-on-steel deck).
- The building envelope sustained significant damage, including:
 - Loss of a large portion of the roof deck (horizontal envelope, see Fig. 3–28; note that all of the steel trusses supporting the roof appeared undamaged and connected to the roof beams despite the loss of the roof deck) and roof deck covering.
 - Breakage of almost all glass windows and the loss of several architectural spandrel panels (Fig. 3–28). It should also be noted that, despite the breakage of the glass windows, there were no failures in the mullion-and-rail system that held the glass panels, or among the anchors that connected the system to the structural SF of the building.
 - In sum, despite there having been no visible damage to the structural frame, the damage to the building envelope facilitated further damage to the building’s interior and, as a result, rendered this building unusable.



Figure 3–28. View of damage to envelope of Medical Office Building 1.

Medical Office Building 2

This was a four-story steel frame building on concrete slab foundation. The design and damage information is described below.

Design Information:

- Year Built: 1994.
- Building Code: BOCA National Building Code/1990.
- Design Wind Speed: 70 mph (in fastest mile, or about 85 mph in 3 second gusts).
- MWFRS: Steel braced frame system comprised of W-shape beams and columns, joined by bolted-and-welded connections, and steel K-braces for lateral load capacity.
- Floor System: Composite concrete-steel deck floor (4½ in. thick concrete slab on 2 in., 18-gauge (0.0474 in. thick) wide-rib galvanized steel deck).
- Components and Cladding:
 - Envelope: The building vertical envelope consisted of (a) single-story glass panels with aluminum framing, (b) brick veneer backed by aluminum stud frames (on three sides: west; north; and south), and (c) architectural spandrel panels made of cement-based surface boards and a layer of insulation material, supported by aluminum frames.
 - Roof: 1½ in. × 6 in., 22-gauge wide-rib galvanized steel roof deck supported by open-web steel roof joists.

Damage and Performance Information:

- There was no structural damage to the MWFRS (steel braced frame) or the gravity load floor system (composite RC-on-steel deck).
- The building envelope sustained significant damage, including:
 - Loss of steel roof decks and roof deck covering (horizontal envelope).
 - Breakage of curtain walls on all wind-exposed sides (broken glass windows and loss of architectural spandrel panels; see Fig. 3-29, 3-30, and 3-31).

Physician's Office Building

This was a two-story steel frame building. The design and damage information is described below.

Design Information:

- Year Built: 1988.



Figure 3–29. Views of (top) damage to envelope of Medical Office Building 2 and (bottom) portion of the steel frame system (bolted beam–column connection).



Figure 3–30. Evidence of debris impact causing breakage of windows at Medical Office Building 2.



Figure 3–31. Roof aggregate ballast became wind-borne debris (on ground by Medical Office Building 2).

- Building Code: BOCA National Building Code/1987.

- Design Wind Speed: Actual design information was not available. The design wind speed was likely 70 mph (in fastest mile, or about 85 mph in 3 second gusts) given the time of construction and the building code then in effect.
- MWFRS: Two-story steel frame that comprised of W-shape beams and columns joined by bolted-and-welded connections.
- Floor System: Composite concrete-steel deck floor (4½ in. thick concrete slab on 2 in., 18-gauge wide-rib steel deck).
- Components and Cladding:
 - Envelope: The building vertical envelope consisted of single-story glass panels with aluminum framing and architectural metal insulated panels supported by metal studs frames.
 - Roof: 1½ in. × 6 in., 22-gauge wide-rib galvanized steel roof deck supported by open-web steel roof joists.

Damage and Performance Information:

- There was no structural damage to the MWFRS (steel frame) or the gravity load floor system (composite RC-on-steel deck).
- The building envelope sustained significant damage, including:
 - Loss of steel roof decks and roof deck covering (horizontal envelope).

Breakage of curtain walls (broken glass windows and loss of architectural metal panels) and collapse of an entire brick veneer curtain wall and the supporting aluminum stud frame on the south-facing wall of the building (see Fig. 3–32).



Figure 3–32. Collapse of an entire brick veneer curtain wall and the supporting aluminum stud frame on the south-facing wall of Physician’s Office Building.

3.2.1.2 Walmart

Figures 3–33 and 3–34 show overviews of the partially collapsed Walmart Store 59 at 1501 South Range Line Road in Joplin. The store was a one-story, low-rise BTS with a long-span, flexible diaphragm metal roof. The building was rectangular in plan, with the long side in the north-south direction and perpendicular to the translational direction of the tornado, with approximate dimensions of 573 ft (N-S) by 290 ft (E-W), a 21.33 ft mean roof height and a 2 ft parapet. The southernmost end of the building was approximately 750 ft north of the estimated center line of the tornado damage path. Estimation of the wind speeds affecting the store (see Fig. 3–35 and 3–36) shows a wind speed gradient along the length of this building: the uncollapsed north half experienced an estimated maximum wind speed of 120 mph \pm 20 mph (EF-2 range, from a northerly wind direction) and the collapsed south half experienced a higher maximum estimated wind speed of 165 mph \pm 20 mph (EF-3 to EF-4 range, from a west-northerly wind direction). Indications that the north half was in a lower wind speed zone also can be seen in Fig. 3–33, which shows that areas directly east and west of this portion of the building sustained much less damage to structures and vegetation compared with areas further south and closer to the tornado center line. The sections below summarize the design, damage, and performance information related to this building.

Design Information:

- Year Built: Original design, 1993; remodel, 2007.
- Building Codes: Original, BOCA National Building Code/1990; remodel, 2000 IBC.
- Design Parameters:
 - Basic Wind Speed: Original design, 85 mph (3 second gusts); remodel, 90 mph (3 second gusts).
 - Exposure Category: C.
 - Importance Factor: 1.15.
- Structural System: The structural system comprised three structural components: the roof system; a series of steel interior gravity frames; and the perimeter walls. The roof system and perimeter walls formed the primary lateral load resistance system (MWFRS), while the interior gravity frames and the walls were the primary gravity load resistance system. The descriptions of these structural components follow:
 - Roof System: The structural role of the roof was to (a) support and transfer vertical roof loads to the series of individual plane frames, and (b) serve as a structural diaphragm providing lateral support for the perimeter walls. The roof system comprised:
 - Steel roof decks: 1½ in. \times 36 in., 22-gauge (lightest gauge for roof decks, 0.0295 in. thick), type B painted wide-rib steel roof decks that were fastened to and supported by the trusses described below.



Figure 3–33. Aerial views of Walmart in relation to the tornado damage path (red line denotes center of damage path).

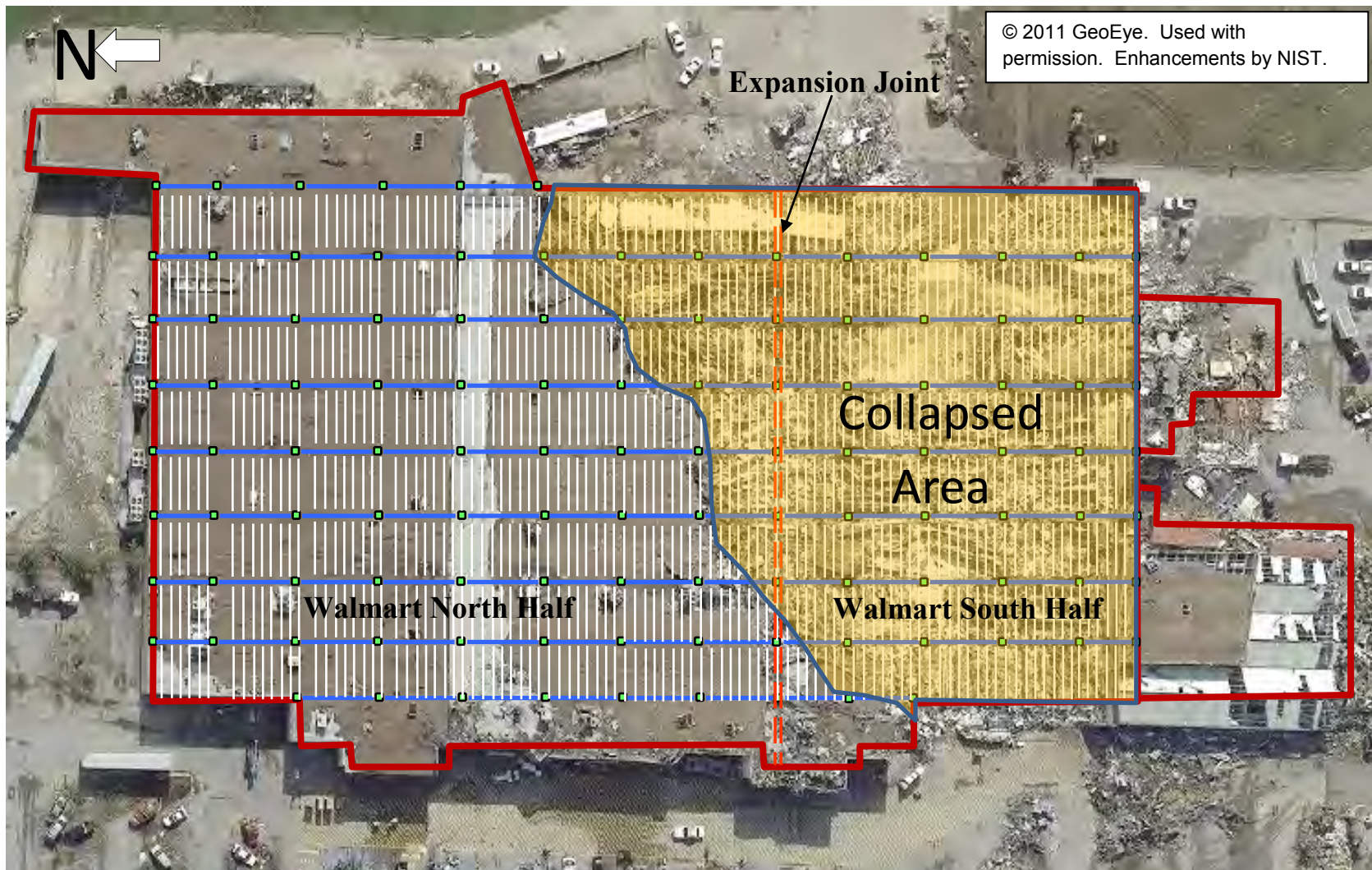

Figure 3–34. Aerial view of Walmart outlining southern half of building collapsed by the tornado.

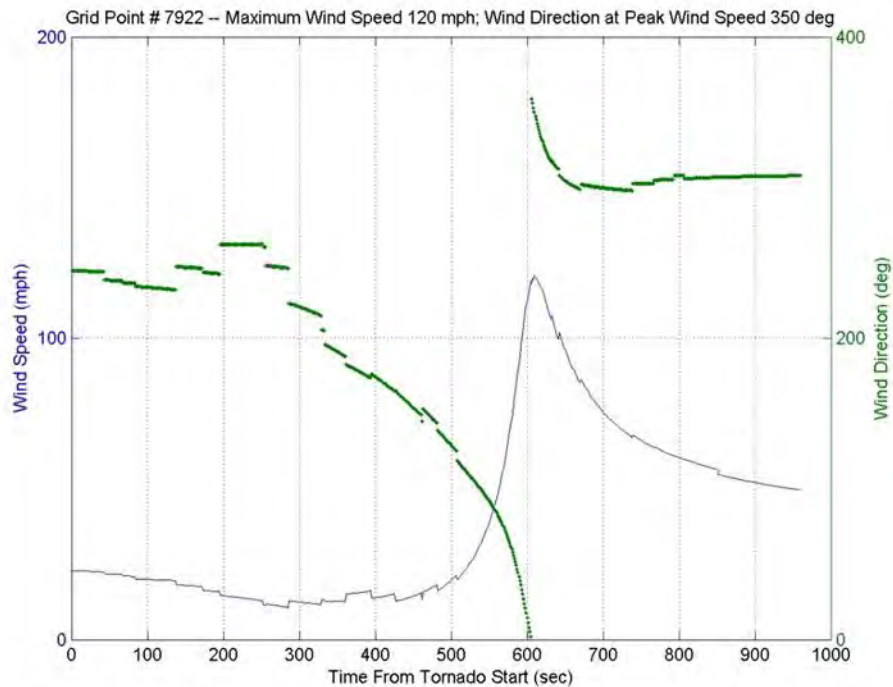

Figure 3–35. Time–history of wind speed affecting Walmart north half.

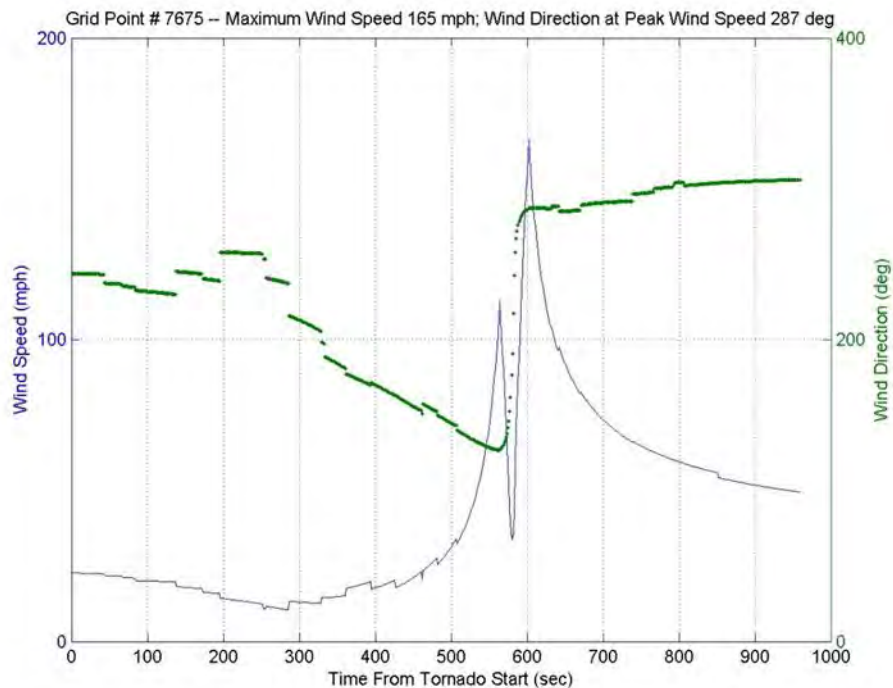

Figure 3–36. Time–history of wind speed affecting Walmart south half.

- Steel roof trusses: K series open–web steel roof joists were typical (except in the vestibule area where longer–span LH series joists were used). The connections between the roof decks and roof joists were primarily 5/8 in. diameter puddle welds in a 36/7 fastener pattern (7 puddle welds across the 36 in. wide steel deck panel). Adjacent roof joists were bridged at three points each along the top and bottom chords for lateral stability using L1¼ × 1¼ × 1/8 steel angles. Each roof joist was additionally braced for uplift resistance by two steel angles, one at each joist end, that were field welded (3/16 in. fillet weld) to the joist’s first bottom chord panel points and the bottom chord of the supporting joist girder (see description of joist girders below).
- Interior Gravity Frames: The structural function of these frames was to support and transfer vertical loads only from the roof system to the foundation through connections with the roof joists. These frames were run in the N–S direction, each with multiple spans. Each span consisted of:
 - An open–web steel joist girder that supported the roof joists through field welded connections to its top chord (two 3/16 in. × 1½ in. fillet welds at each end of the roof joist). The joist girder was supported at each end of its top chord by the column and base plates described below.
 - A structural steel tube column (TS 8 × 8 × ¼ typical interior column). The joist girder–to–column connection was a simple shear connection that included two ¼ in. × 3 in. field fillet welds and two ¾ in. diameter bolts (bottom chord of joist girder straddled, but was not connected to, the column’s stabilizer plate). The end columns of the frame were embedded into (but not connected to) the perimeter CMU walls. The columns in turn were supported on the following:
 - Steel base plates and individual RC square footings.
- Perimeter Walls: The structural role of the walls was to support both vertical and lateral loads (wind and seismic), with lateral bracing provided by the roof system that acted as a horizontal diaphragm. The stability of the perimeter walls was critically dependent upon this roof diaphragm action. The perimeter walls comprised 12 in. thick CMU walls (12 in. × 16 in. × 8 in. blocks), partially grouted and reinforced with #6 rebar in the vertical direction (through the wall’s height) at 4 ft on center (vertical grouting in every sixth cell of CMU blocks). The vertical reinforcements extended from the wall bottom into the RC spread footing using standard ACI hooks. This wall–to–footing connection by single dowels at 4 ft on center provided continuity between the wall and the footing and restraint against lateral displacement of the wall (dowel action plus friction), but essentially no restraint against wall rotation.⁸¹ For continuity in the horizontal direction, the top and bottom courses of the CMU walls were also grouted and reinforced horizontally with two #5 reinforcing bars to form two continuous bond beams.

⁸¹ This is not inconsistent with standard practice. A friction-only connection between wall and footing is accepted for regions with low or no seismic risk. The wall’s rotational stability is to be provided by temporary bracing during the construction phase (prior to connection to the roof system) and by lateral bracing provided by the roof system after connection with the roof.

Additional wall continuity was provided by a square structural steel tube link beam (TS $2\frac{1}{2} \times 2\frac{1}{2} \times 3/16$) welded to steel plates that were anchored into the bond beam at regular intervals along the tops of the perimeter walls.

- Components and Cladding:
 - Envelope: CMU exterior, with sliding doors with $\frac{1}{4}$ in. tempered glass and aluminum frames at the north and south entrances on the west wall.
 - Roof Covering: Rigid insulation on the metal roof deck, covered by roof membrane.
- Other Features: An expansion joint cut through the RC floor slab and the east and perimeter walls, along the E–W direction at 209.5 ft from the south wall, effectively dividing the building into two independent structural subsystems, a north half and a south half. The horizontal reinforcements in the bond beams were terminated at this expansion joint.

Damage and Performance Information:

- The MWFRS of the south half of the building (perimeter walls laterally braced by roof system) completely collapsed, with:
 - The entire roof system (roof deck and roof joists) disconnected and either displaced upward or was completely blown away from the supporting joist girders and walls (evidence of wind uplift action, see Fig. 3–37 and 3–38).
 - The west and east walls (where the roof system that was supposed to provide lateral bracing was lost), and portions of the south wall, collapsed inward due to rotation at the base.
- The MWFRS of the north half partially collapsed, with:
 - A portion of the roof system (southeast corner) disconnected and either displaced upward or blown away from the supporting joist girders and walls (see Fig. 3–37 and 3–38).
 - A section of the east wall that was braced by this portion of the roof collapsed inward due to rotation at the base.

Beyond the collapsed area described above, the structural system of the north half of the building appeared intact. It should be noted that the fact that this portion of the building did not sustain more significant damage was more indicative of a less violent wind field than of better structural performance.

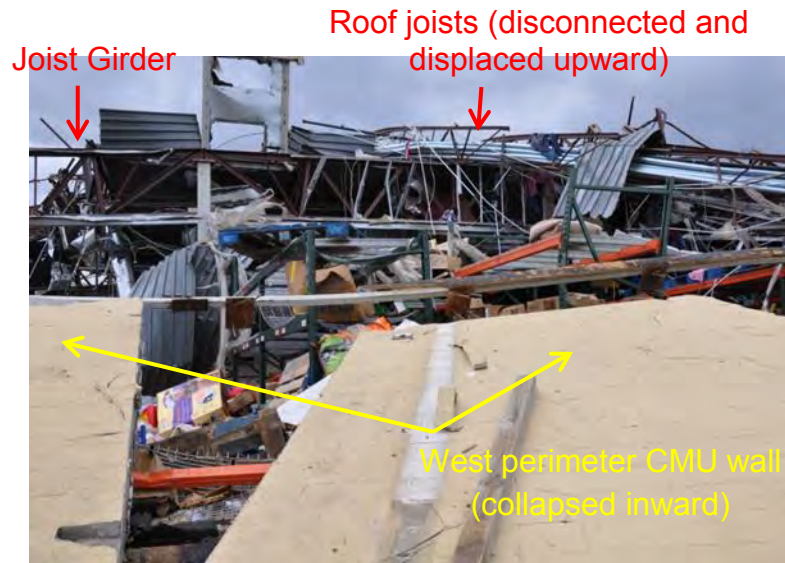

Figure 3–37. Roof system (decks and joists) missing. Some roof joists displaced upward (top chords used to be at same elevation as top chords of joist girders, but now sitting above joist girders), showing evidence of wind uplift action as primary cause of failure.



Figure 3–38. Large area of roof system shown missing. Joist girders bent upward due to uplift pressure.

- The gravity system (steel plane frames) was mostly intact, albeit damaged, with:
 - Most joist girders having remained in place and connected to the columns, although many were damaged and bent upward (again, evidence of wind uplift action prior to the failure of the roof system; see Fig. 3–38). There were a few girders that were disconnected from the columns on one end. These appeared to have been secondary failures (after loss of the roof system and therefore any lateral bracing for the girders).
 - The majority of the interior columns having remained in place and connected to the concrete foundation. The few that were bent also appeared to have been the result of secondary failure.
- Envelope:
 - The entryway door panels (tempered glass and aluminum frame) on the west wall were lost and there was damage to the fire-escape door on the east wall and to the store's exterior signage. These impacts were likely due primarily to wind pressure. Whole door panels, including the glass and aluminum frame, were missing. (The glass on door panels that remained appeared intact (see Fig. 3–39). This allowed wind to infiltrate the building interior and resulted in increased wind uplift pressure on the roof system.
 - Most of the membrane and rigid insulation was lost from the roof, even in the north half of the building where structural failure did not occur.
- Fatalities and Injuries: The structural collapse of the Walmart building on May 22, 2011, caused three fatalities and an unknown number of injuries among the approximately 200 occupants.



Figure 3–39. Missing door and glass panels and damage to signage at south entrance on west wall (envelope failure allowing air infiltration to the interior and causing increased wind uplift).

Possible Failure Sequence:

The observed damage and structural failures described above were assessed along with an eyewitness account given by a survivor who was a Walmart employee and took shelter in a designated safe area inside the building pursuant to Walmart's emergency sheltering procedure. This information suggested that the following sequence of events likely led to the total collapse of the south half and partial collapse of the north half of the Walmart building:

1. Wind pressure built up and caused the failure of components of the building envelope and wind infiltration into the building interior (through the entryway door and window panels in the front (west) wall, the fire-escape door in the back (east) wall, and exterior signage; see Fig. 3-39).

The following was excerpted from the eyewitness account:

“There was a very strong vacuum, and it blew out all the glass windows. It exploded the back. The two doors that were there in that area went straight open. The fire escape door that was right through them just flew back and just boom, boom, boom—just smacked back at an incredible force”. (NIST Interview 99)

2. Increased internal uplift pressure due to wind infiltration, combined with external uplift pressure on the roof, caused the roof-joist-to-joist girder connections, which tied the roof system to the gravity plane frame system, to fail (as evidenced by the loss of large sections of the roof system). Between the two critical connections of the roof system—the deck-to-joist connection and the joist-to-joist girder connection—the joist-to-girder connection was the weaker connection based on the available design information, and the net uplift pressure required for this connection to fail is estimated to be approximately 114 lb/ft² (see Appendix H). It should be noted that the uplift pressure required for this connection to fail well exceeds the maximum design uplift pressure of 28.6 lb/ft² estimated for this building based on normal wind design parameters in accordance with IBC 2000 (also see Appendix H). Additional excerpts from the eyewitness account follow:

“And at that point, the ceiling tiles lifted up, the lights went out, and...

The girders⁸² broke all around us; they were like crashing down”.

3. Loss of the roof system resulted in the loss of critical lateral bracing for the exterior walls. The now laterally unsupported walls, which were designed with vertical beam-columns simply supported at the footing and at the connection to the roof system, became cantilevered and subsequently failed inward by overturning due to inward lateral wind pressure (see Fig. 3-40 and 3-41). Following is another excerpt from the eyewitness:

⁸² Term probably used imprecisely by interviewee. Could refer to either roof joists or joist girders.

“So basically what happened is the ceiling fell down, landed on those cabinets, and then the back wall fell down on top of that, and so it made—the back wall made that girder squash down, so it made the front of our little hole be a triangle shape at about a 45-degree angle”.



Figure 3–40. Collapsed east wall due to loss of roof lateral bracing and inward wind pressure.

3.2.1.3 Home Depot

Fig. 3–42 shows an overview of the completely collapsed Home Depot building, located at 3110 East 20th Street in Joplin, approximately 400 ft south of the estimated center line of the tornado damage path. This building was a one-story, low-rise BTS building (28 ft mean roof height and 4 ft parapet) with a long-span roof and RC tilt-up perimeter wall panels. The building was rectangular in plan, with approximate plan dimensions of 470 ft (N–S) by 250 ft (E–W). The long side of the building was in the north–south direction, perpendicular to the tornado direction. Fig. 3–43 shows the time–history of wind speed estimated for this location, which indicated that the building was subjected to an estimated maximum wind speed of about 165 mph \pm 20 mph (EF–3 to EF–4 range) from a west–southwesterly direction. The sections below summarize the design, damage, and performance information related to the Joplin Home Depot.

Design Information:

- Year Built: 2000.
- Building Code: BOCA National Building Code/1996.

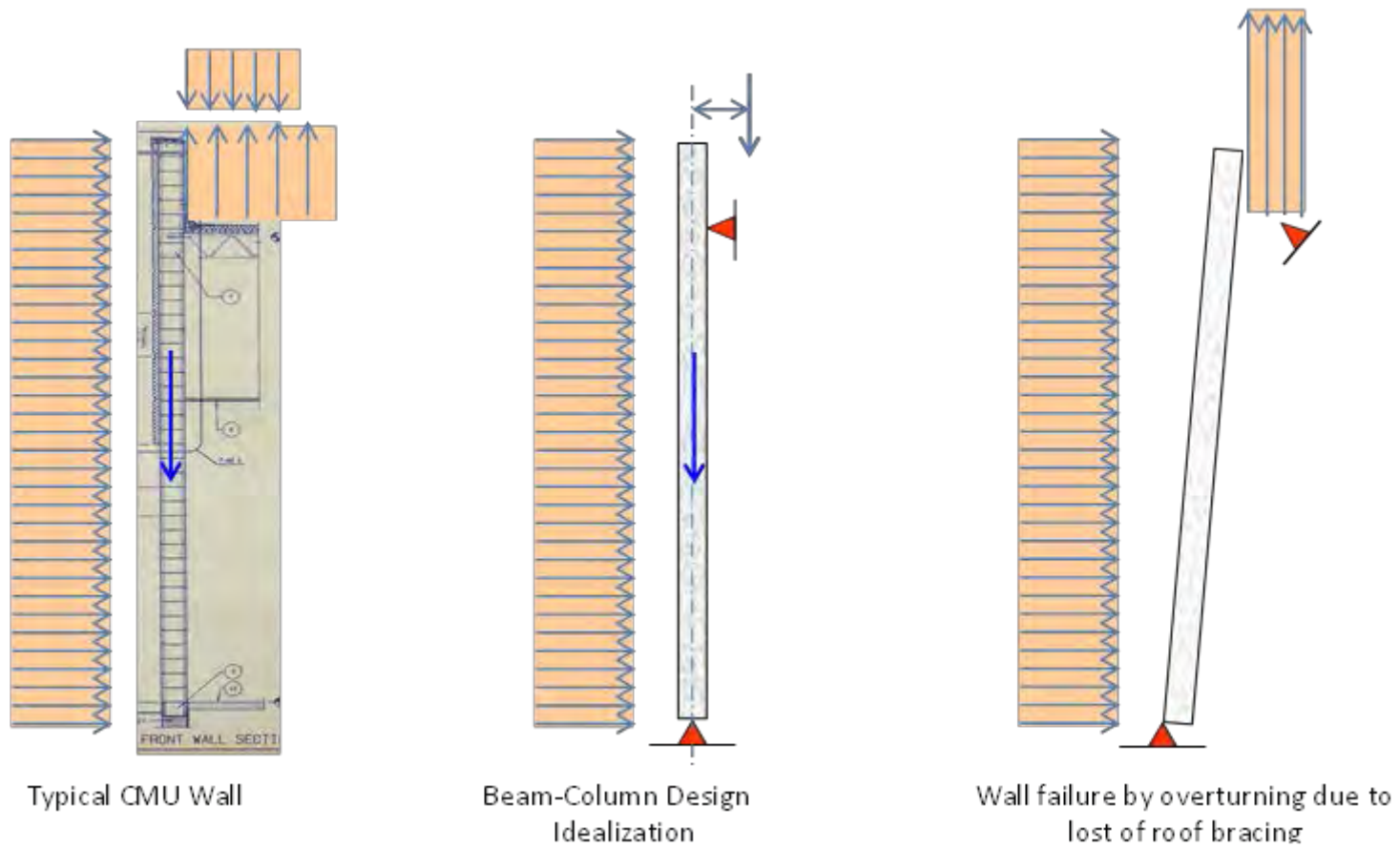

Figure 3–41. Typical loading and design conditions for BTS building and possible failure mode.

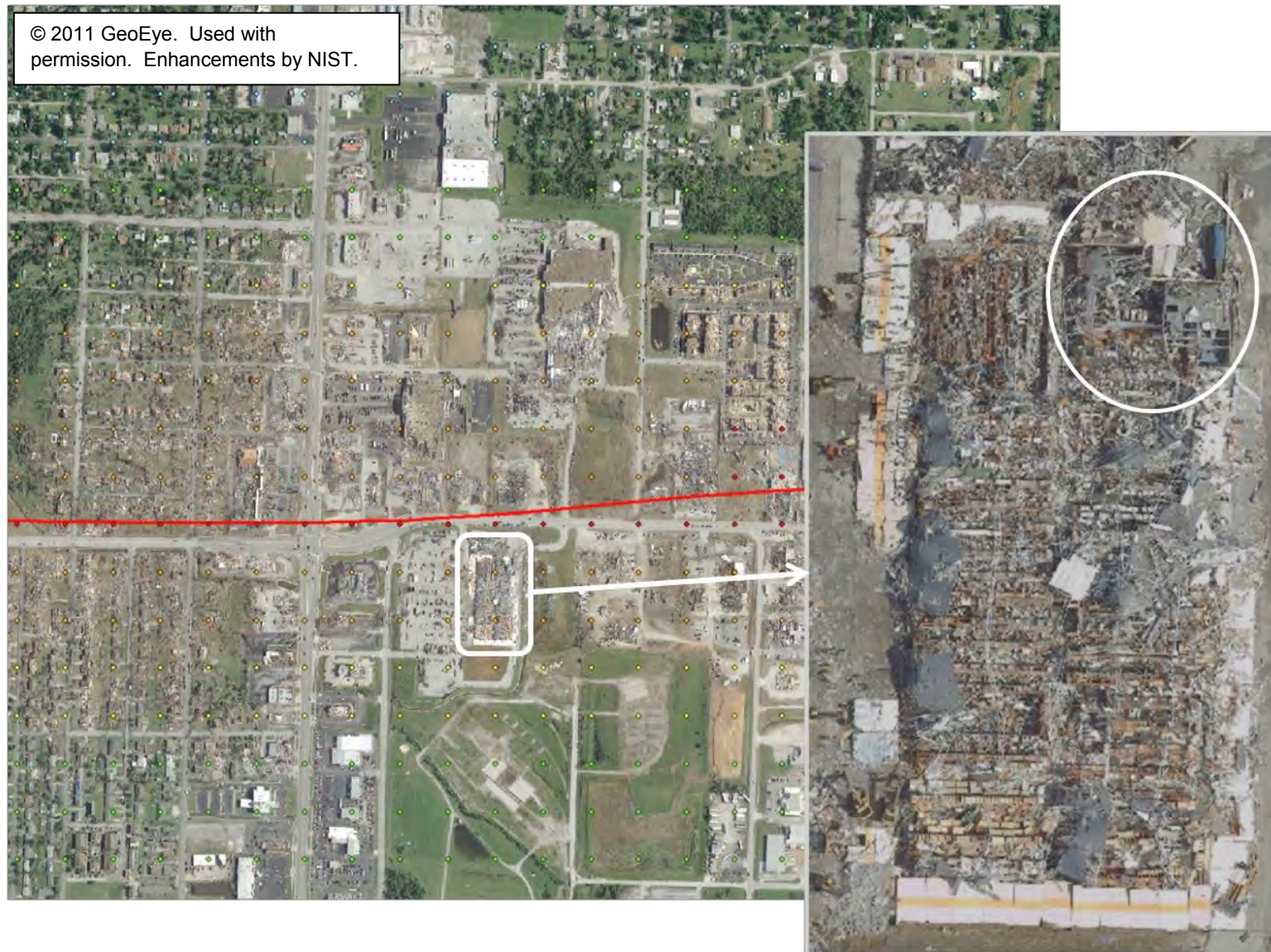

Figure 3–42. Aerial views of Home Depot in relation to the tornado damage path (red line denotes center of damage path). Note the loss of all roof decks due to wind uplift.

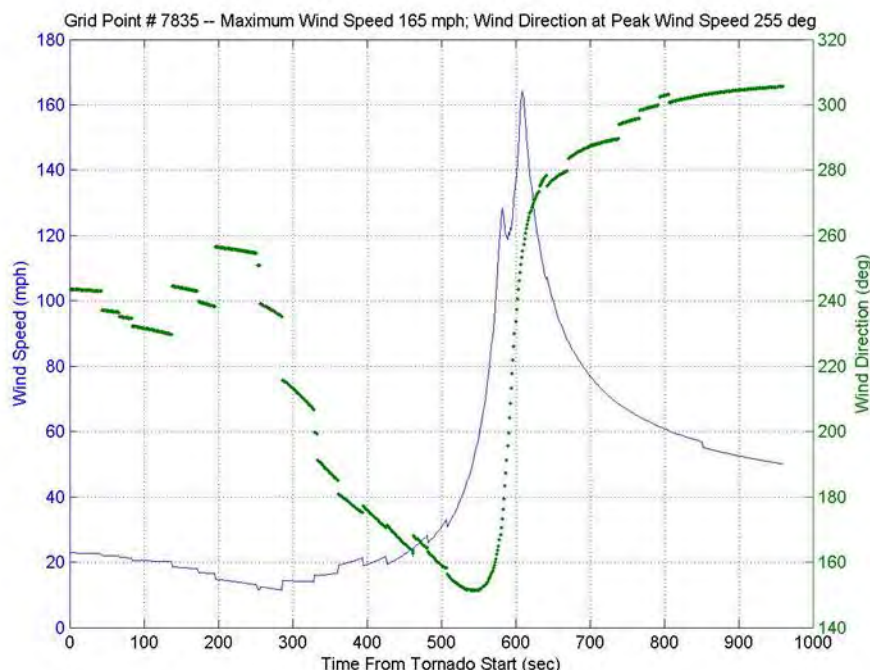

Figure 3-43. Time-history of wind speed and direction affecting Home Depot.

- Design Parameters: Basic wind speed, 90 mph (3 second gusts),⁸³ exposure category C.
- Structural System: The structural system comprised three structural components : the roof system, a series of five interior gravity steel frames, and the perimeter tilt-up concrete wall panels. The roof system and perimeter tilt-up walls formed the primary lateral load resistance system (MWFRS), while the interior gravity frames and the walls provided the primary gravity load resistance system. The descriptions of these structural components follow:
 - Roof System: The structural functions of the roof were to (a) support and transfer vertical roof loads to the plane frames and the exterior tilt-up RC walls, and (b) provide lateral support for the walls. This system, which was divided into two sections by an expansion joint located 188 ft from the south wall (close to mid-span), included the following components:
 - Steel roof deck: 1½ in. × 36 in., 22-gauge (0.0295 in. thick) type B painted wide-rib steel roof deck panels supported by steel roof trusses.

⁸³ Design drawings indicated that the design code was BOCA NBC/1996, which specified a basic wind speed of 70 mph (fastest mile, or about 85 mph in 3 second gusts) for the location of the Joplin Home Depot, but also provided a specific design wind speed of 90 mph (5 mph higher than the code-specified basic wind speed for the building).

- Steel roof trusses: Primarily K series and some LH series open-web steel roof joists (in E-W direction), designed as simply supported, with top and bottom chords of adjacent joists braced against lateral buckling and uplift forces with steel bridging members per the Steel Joist Institute (SJI) specifications. The roof decks were 36 in. wide and three-span continuous, and were fastened to the roof joists (support fasteners) using 5/8 in. diameter puddle welds in a 36/4 fastener pattern, and along the side seam (side laps) using #10 Buildex screws (7 screws per span) (see Fig. 3-44).
- Interior Gravity Frames: The gravity load system consisted of five plane frames (N-S) with typical spacing of 40 ft. Each had 10 columns (11 spans). This system transferred vertical loads from the roof to the foundation through connections with the roof joists.

Each span consisted of an open-web steel joist girder supported on each end by structural steel square tube columns (TS 8 × 8 × 0.25) through a simple shear connection using either two 3/4 in. diameter A325 bolts or two 1/4 in. × 2 in. fillet welds (E70 electrode). The bottom chord of the joist girder straddled but was not connected to the column's stabilizer plate (see Fig. 3-45). Each column was supported on a 14 in. × 14 in. × 3/4 in. steel base plate that was anchored into the concrete individual footing using four 3/4 in. diameter hooked anchors.

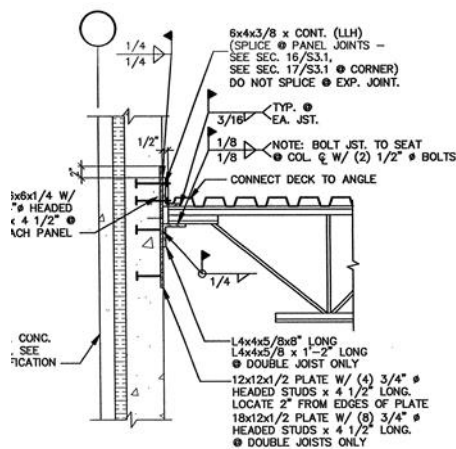

© 2013 Homer TLC, Inc. Used with permission.

Figure 3-44. Typical connection between the roof system and the perimeter tilt-up RC wall

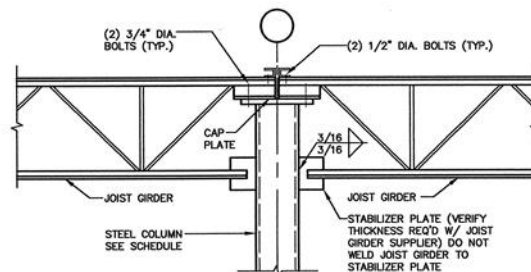

TYPICAL JOIST GIRDER TO COLUMN CONNECTION

© 2013 Homer TLC, Inc. Used with permission.

Figure 3-45. Typical connection between roof joist girder and interior column

- Perimeter Walls: The walls supported both gravity and lateral loads and acted as shear walls laterally braced for stability by the roof system acting as a horizontal diaphragm. They were typically designed following the American Concrete Institute (ACI) Committee 551 guidance on tilt-up concrete structures. The walls consisted of 73 tilt-up RC non-composite sandwich panels, each 12 in. thick and comprising three layers: a 7½ in. thick RC structural wythe, a 1½ in. thick layer of insulation, and a 3 in. thick concrete fascia wythe (exterior shell). Panel heights varied from 26 ft 8 in. to 34 ft, and their widths varied from 13 ft to 25 ft 7¾ in. The connections for the Joplin Home Depot tilt-up panels were as follows:
 - Panel-to-footing connection: The bottoms of the tilt-up panels extended a short distance below the concrete floor slab/soil surface level and were supported on strip RC footings. For the majority of the tilt-up wall panels (64 of 73), the panel-to-footing connections were primarily by friction⁸⁴ (i.e., there was no positive anchorage between the bottom of the wall and the footing), with the only connection afforded by embedment of #4 reinforcing bars at 24 in. spacing between the sides of the walls and the concrete slab-on-grade (mainly to restrain against lateral movement; see Fig. 3–47). This combination of friction-only connection to the footing and dowel embedment to the slab-on-grade provided restraint to lateral movement but not against rotation at the base of the wall panels. However, for the remaining nine tilt-up panels, which were all located at the northeast corner of the building around the loading dock, the wall-to-footing connections were more robust with mechanical connections to the strip footing (through the use of dowels connected to an 18 in. × 18 in. concrete block on top of the footing) in addition to the dowel connections to the floor slab (see Fig. 3–46). This positive connection to the strip footing, likely designed to protect against the potential for delivery trucks accidentally striking walls in the loading dock area, provided these 9 panels with a partially fixed base connection and thus a more robust rotational restraint compared with the other 64 panels with friction-only connections (see Fig. 3–47).
 - Panel-to-roof-joist connection: The tilt-up wall panels were braced laterally by the roof system through connections with the roof trusses. Each roof truss was connected at the top chord to steel seat angles embedded to the tilt-up panel by two 1/8 in. × 1 in. field fillet welds (E70XX) and one 3/16 in. × 1 in. field fillet E70XX weld (see Fig. 3–48).
 - Panel-to-panel connection: Adjacent panels were not connected along their vertical sides.
- Components and Cladding:
 - Envelope: The building envelope consisted of concrete exterior walls and metal roll-up doors.

⁸⁴ This is not inconsistent with design guidance by industry standard (ACI 551) for areas with low or no seismic risk.

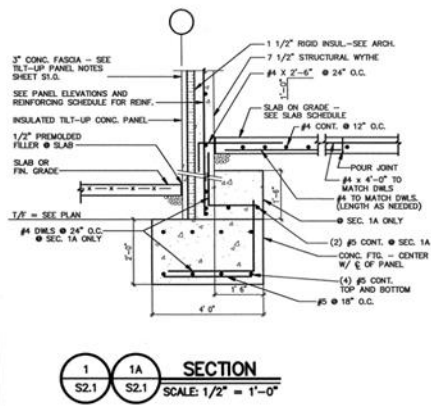
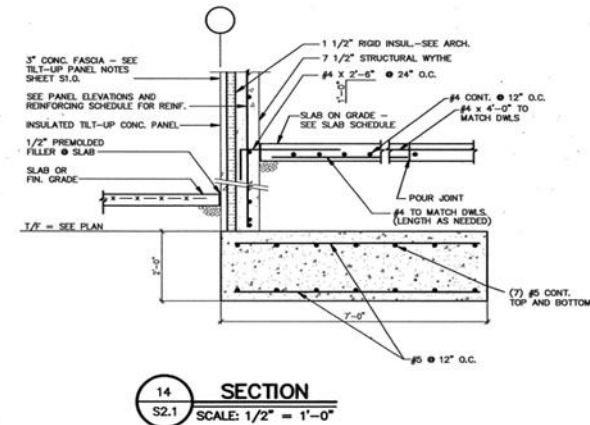

Figure 3-46. Positive wall-to-footing connection (dowels connection to footing and concrete block, in 9 tilt-up wall panels near loading dock)

Figure 3-47. Friction-only wall-to-footing connection (in remaining 64 tilt-up RC wall panels)



© 2013 Homer TLC, Inc. Used with permission.

© 2013 Homer TLC, Inc. Used with permission.

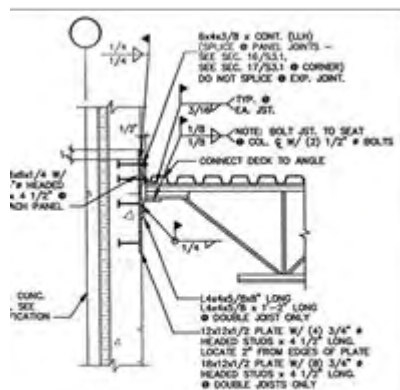

© 2013 Homer TLC, Inc. Used with permission. Enhancements by NIST.

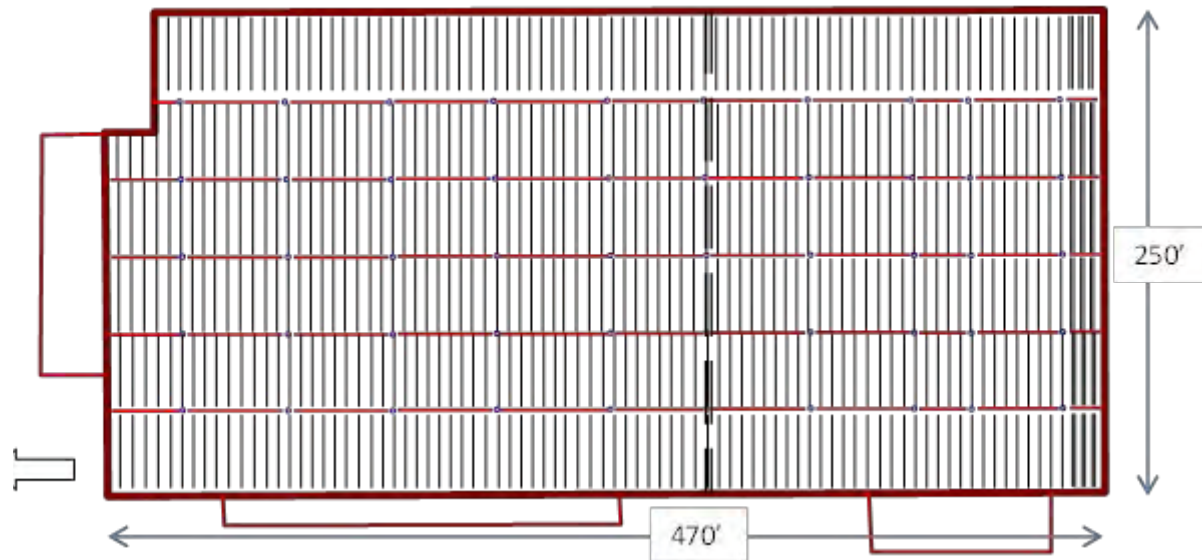

Figure 3-48. Roof framing plan (right) and typical roof joist-to-wall panel welded connection (left)

- Roof Covering: On the steel roof deck, there were rigid insulation panels covered by single-ply EPDM roofing membrane.

Damage and Performance Information:

- The MWFRS (perimeter tilt-up walls and roof system) completely collapsed:
 - The entire roof system (roof deck and roof joists) disconnected from the perimeter wall panels and the gravity plane frames, with almost all of the roof joists disconnected, displaced upward, or completely blown away from the supporting joist girders and walls (for evidence of wind uplift action, see Fig. 3–42 and 3–49). Note that where the roof system did not get blown away from the site, some of the metal roof decks appeared to remain connected to the roof joists (through the field puddle-weld connections).
 - Sixty-three out of 73 tilt-up panels collapsed either inward or outward and only 10 remained standing. Of the 63 collapsed panels, all but 2 had the friction-only connection to the strip footing (see Fig. 3–46, 3–47, and 3–48). The 10 uncollapsed panels were adjacent to each other and were part of the group of panels located around the loading dock at the northeast corner of the building. Seven of these 10 had positive connections to the footing. The three with friction-only connections to the footing that also remained standing appeared to have been supported against outward rotation by steel shelving located on the exterior side of these panels (see Fig. 3–50).
- All five of the steel plane frames (gravity load system) were damaged but remained generally at their original locations (were not blown away):
 - Many joist girders bent laterally or disconnected on one end from the interior columns. These appeared to have been secondary failures after the loss of the roof system and therefore the loss of any lateral bracing for the girders and the frames.
 - Many interior columns either buckled at mid-height or disconnected at the base (fracture or pull-out of anchors) from the slab-on-grade. These failures also appeared to be secondary failures that occurred after the loss of lateral bracing due to failure (disconnection) of the roof deck (see Fig. 3–51).
- The loss of the entire roof system and collapse of the wall panels represented a failure of the building envelope. It is not known if the doors on the north, east, or west walls were breached prior to the collapse of the entire building. However, the metal roll-up doors at the loading dock on the north wall (uncollapsed wall panels) appeared to have remained closed during and after the tornado.
- Fatalities and Injuries: Death certificates obtained by NIST showed that eight fatalities occurred at the Home Depot. The deaths were likely the result of the structural collapse of the building. However, NIST has not been able to definitively confirm the exact locations of the victims inside the Home Depot or the circumstances related to their deaths.



Figure 3–49. Collapsed Home Depot building (view from the northwest). Note the loss of all roof decks and upward displacement of joists and joist-girders



Figure 3–50. Ten tilt-up panels in the northeast corner remained standing. Seven of these 10 panels had positive connections to the footing and thus some degree of restraint against rotation. The other three uncollapsed panels had friction-only connections to the footing but appeared to have been supported against falling outward by steel shelving on the exterior side (Garden Center).



Figure 3–51. Damaged joist girders and interior columns. Note the complete loss of the roof system that was connected to the girders.

Possible Failure Sequence:

The observed damage and structural failures described above suggested that the following sequence of events ultimately led to the total collapse of the Joplin Home Depot building:

1. Wind uplift pressure caused the failure of the roof joist-to-joist girder connections, which tied the roof system to the gravity plane frames and the perimeter tilt-up walls; this resulted in the loss of required lateral bracing for both the plane frames and the walls (as evidenced by the absence of almost the entire roof system). Available design information indicated that, between the two critical connections of the roof system (deck-to-joist and joist-to-joist girder), the joist-to-joist girder was the weaker one and the one likely to have failed first (again evidenced by the loss of the entire roof system) (see Appendix I). Note that the estimated uplift pressure required to incur this failure well exceeds the maximum design uplift pressure of 26.2 lb/ft² estimated for this building based on normal wind design parameters in accordance with BOCA NBC/1996.
2. Failure of the roof system resulted in the loss of critical lateral bracing for the exterior tilt-up wall panels as well as for the steel plane frames. The now laterally unsupported tilt-up wall panels that relied on friction-only connections to the footing loads (except for the three panels that were supported by steel shelving in the Garden Center) became unstable and collapsed due to lateral pressures, and those wall panels around the loading dock in the northeast corner of the building that had partially fixed end connections through positive connections to the footing were able to resist the overturning moment and remained standing.

3.2.1.4 Joplin East Middle School

The Joplin East Middle School was a building complex comprising several joined sections. The complex, located at 4594 East 20th Street in Joplin (toward the end of the tornado damage path), had a long and narrow configuration and was oriented in the north–south direction (total length of 664 ft) as shown in Fig. 3-52. It was designed in 2007 and constructed in 2009. All sections (denoted as Sections C, D, E, and F on Fig. 3–53) of the building complex were made primarily of reinforced CMU walls with short–span steel roof decks, except for the Auditorium building (denoted as Sec. B on Fig. 3–53), which had a longer roof span, and the Gymnasium building (denoted as Sec. A), which had precast tilt–up perimeter walls in addition to a longer roof span.

Of the entire school complex, the south end, where the Gymnasium and Auditorium were located, was closest to the estimated center line of the tornado damage path (see Fig. 3–52), and was affected by an estimated maximum wind speed of 170 mph \pm 20 mph (EF–4 range) from a northwesterly direction (see Fig. 3–54). Along the length of the complex, there was a sharp gradient in wind speed with the north end affected by much lower wind speeds compared to those that affected the south end. Consequently, and due to the fact that most building sections of the north end of the school had shorter span roofs, these sections (north of the Gymnasium and Auditorium) sustained only minor damage to their building envelopes, while the Auditorium and Gymnasium buildings sustained total structural collapse of their roof systems and partial collapse of their perimeter walls. Below is design, damage, and performance information pertaining to the two collapsed sections of Joplin East Middle School, the Gymnasium and Auditorium buildings.

Gymnasium Building—

The school gymnasium was a one–story BTS building with a long–span roof (102 ft) and precast concrete tilt–up wall panels that were laterally braced by steel roof decks to form the lateral load resistance system. The roof decks were supported by single–span, open–joist, curved (bow–string) steel roof trusses. The building was approximately 102 ft (N–S) by 142.2 ft (E–W) in plan dimension, and had a mean roof height of 39.8 ft (the east and west walls were curved with minimum heights of 35.3 ft and maximum heights of 43.3 ft). The floor was a 4 in. RC slab–on–grade with 6 \times 6, W1.4 \times W1.4 WWF reinforcement.

Design Information:

- Year Built: 2009.
- Building Code: 2000 IBC.
- Design Parameters: Basic wind speed, 90 mph (3 second gusts); Importance Factor $I = 1.0$; exposure category C.
- MWFRS: The MWFRS comprised two subsystems: the roof; and the perimeter tilt–up precast concrete wall panels.

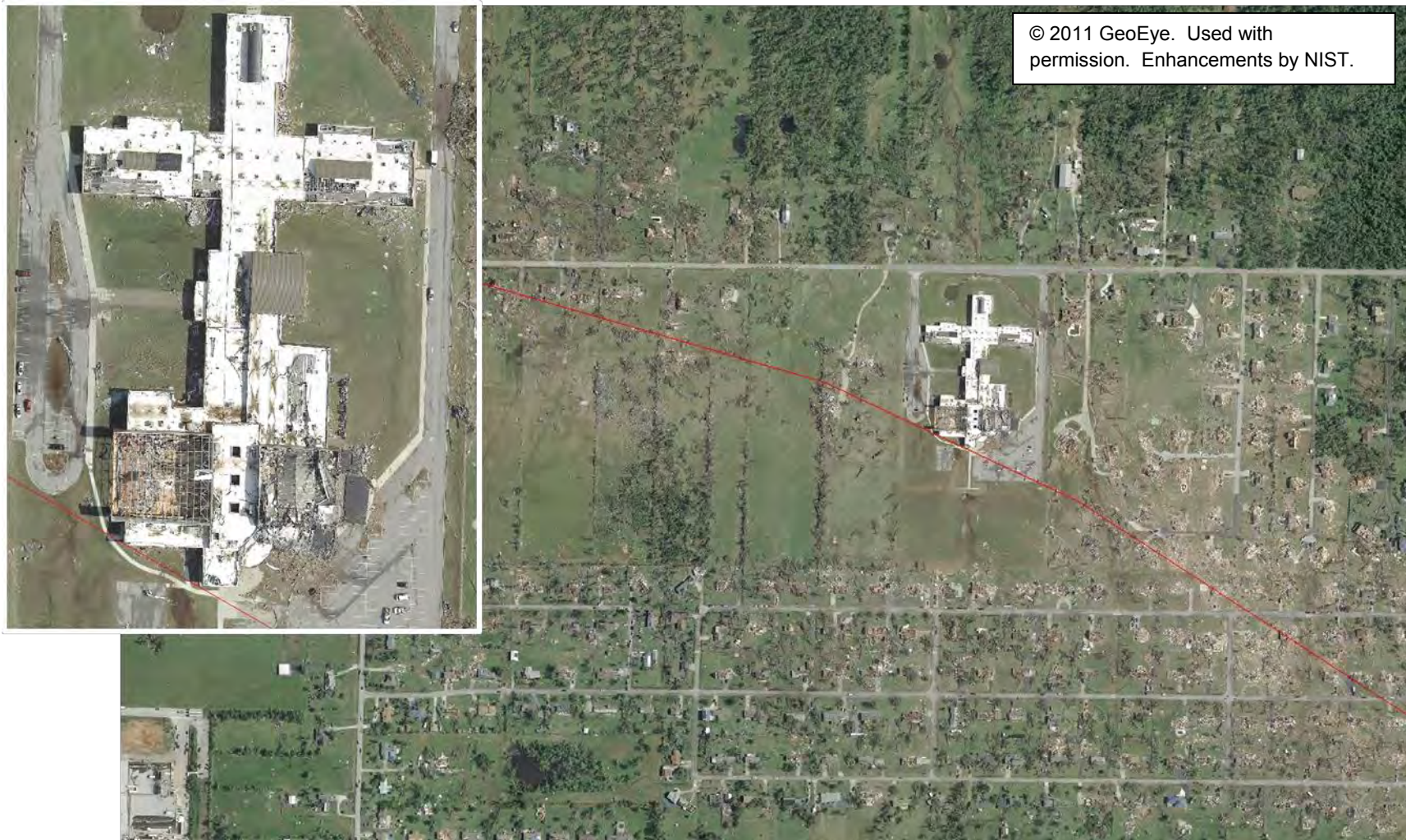

Figure 3–52. Aerial views of Joplin East Middle School in relation to the tornado damage path (red line denotes center of damage path).

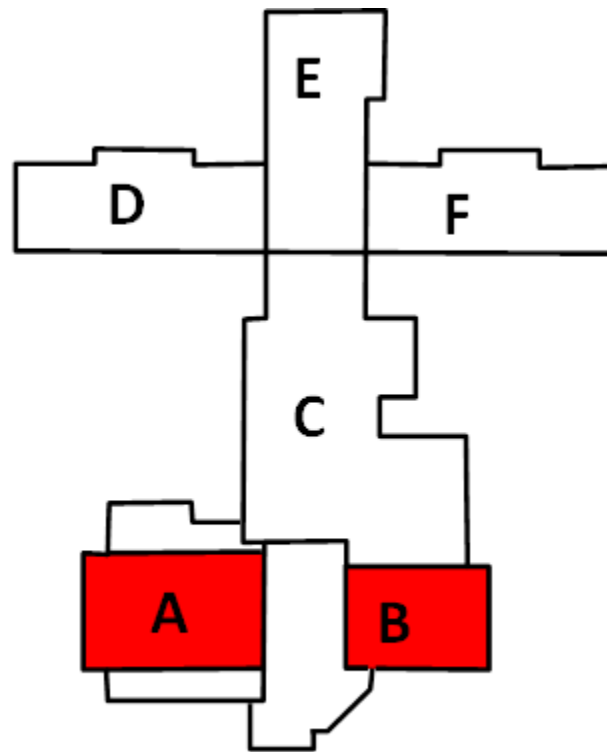

Figure 3–53. Layout of the Joplin East Middle School building complex. The Gymnasium (A) and Auditorium (B) sustained the greatest damage in the tornado.

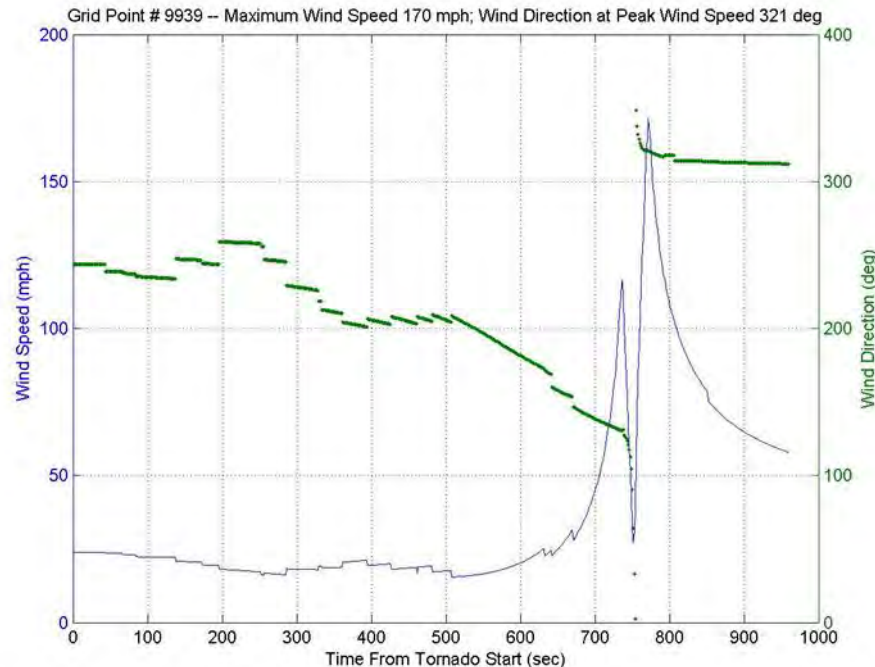

Figure 3–54. Time–history of wind speed and direction at the south end of Joplin East Middle School (over the Gymnasium).

- Roof System: This structural subsystem provided lateral bracing for the perimeter precast wall panels, and consisted of the following:
 - Steel roof decks: 3 in. deep × 24 in. wide, 20–gauge (thickness: 0.358 in.), three–span, type NA acoustic roof decks (this type of roof deck is well–suited for applications where it is desirable to space the supporting members as far apart as possible as in the case of school gymnasiums). The roof decks were fastened to the supporting steel trusses by 5/8 in. diameter puddle welds using a 24/4 connection pattern. Adjacent deck panels were connected along the side lap using #10 Buildex screws with 10 screws per span.
 - Steel roof trusses: 14 single, long–span (102 ft span) bow–string trusses, installed in the N–S direction (supported on top of north and south walls) and with 10 ft spacings. The first and last trusses were 5 ft from the end walls (east and west walls). Adjacent trusses were laterally braced with L 2½ × 2½ × 3/16 steel angles. The first two trusses from each end wall were additionally braced together at the top and bottom chord using L 3½ × 3½ × ¼ steel angles. The first and last trusses were braced to the walls with horizontal bridging at top and bottom chords using 11 L 2½ × 2½ × 3/16 angles. Each end of a truss was welded to a 3/8 in. bent plate, which was then welded onto an L 8 × 8 × ½, 1 ft 9 in. long steel seat angle embedded on the top and at the center of the precast tilt–up wall panel with four vertical, ½ in.

diameter, 10 in. long headed studs and three horizontal, ½ in. diameter, 6 in. long headed studs.

- Perimeter Walls: The walls supported both gravity and lateral loads and acted as shear walls laterally braced by the roof horizontal diaphragm system. They were typically designed following the ACI 551 guidance on tilt-up concrete and the Precast/Prestressed Concrete Institute's (PCI) *PCI Design Handbook: Precast and Prestressed Concrete* (PCI 1999). They consisted of 50 precast concrete tilt-up panels with widths of 10 ft and 6 ft ((46) 10 ft wide panels and (4) 6 ft wide panels). Each panel had three layers: a 10 in. thick inner layer of precast structural concrete; a middle layer of thermal insulation; and an outer layer of brick façade. Each panel was connected to the cast-in-place (CIP) concrete footing at two points along the bottom of the wall panel using 1/4 in. fillet welds (the welds connected two steel plates embedded on the interior face of each wall panel (PL 6 in. × 8 in. × 3/8 in.) to two steel plates (PL 4 in. × 6 in. × 3/8 in.) embedded in the CIP footing). This connection provided restraint against lateral translation of the wall panel but very little restraint against wall rotation (hinge). Adjacent wall panels were linked at the top by a cap beam made of steel channel, which extended from the end of one roof truss to the adjacent roof truss (from the middle of one wall panel to the next), and were also connected at two points along their vertical seams by welding a 4 in. × 8 in. × 3/8 in. steel plate to steel plates embedded in the precast walls.
- Components and Cladding:
 - Envelope: Exterior brick façade.
 - Roof covering: The covering comprised a standing seam metal-barrel roof system over single-ply roof membrane over 4 in. insulation over 5/8 in. type X gypsum board (thermal barrier) over a steel roof deck.
- Other Features: Unlike other stand-alone BTS buildings (e.g., Walmart, Home Depot), which typically have the roof deck act as the sole lateral bracing system for all perimeter walls, the Joplin East Middle School Gymnasium building was part of a building complex and was surrounded by other building sections. As such, three of the four perimeter walls of the Gymnasium (the north, south, and east walls) were laterally braced on their opposite sides through connections with the roof systems of the surrounding building sections, as well as laterally braced by the Gymnasium's roof system (see Fig. 3-55). Thus, the only wall of the Gymnasium that was actually braced solely by its own roof was the west wall. The tilt-up panels of this wall were the ones that collapsed as a result of the May 22, 2011, Joplin tornado, as is discussed below.

Damage and Performance Information:

The damage observed at the Joplin East Middle School Gymnasium building included:

1. The loss of all roof covering materials and most of the metal roof decks (see Fig. 3-56 and 3-57). The disconnection of the roof decks from the supporting bow-string roof trusses appeared to be due to failure of the puddle welds (whole panels, each three-span or 30 ft

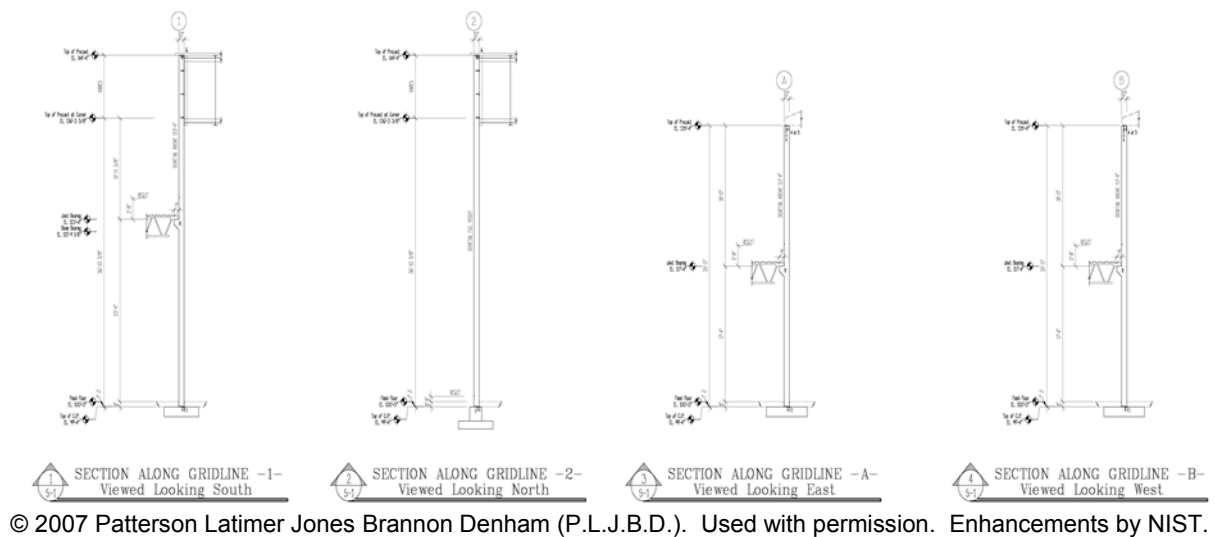

Figure 3–55. Lateral bracing for Gymnasium walls.

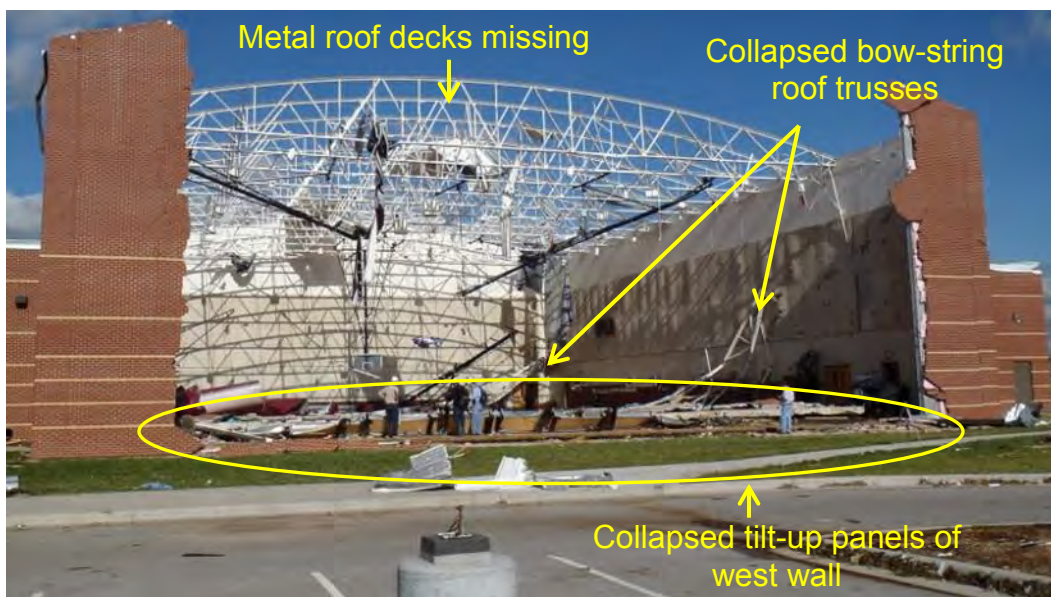

Figure 3–56. Joplin East Middle School Gymnasium building, viewed from the west, showing complete loss of steel roof deck, disconnection and collapse of the first two bow-string steel trusses, and collapse of 9 out of 11 tilt-up panels of the west wall.



Figure 3–57. Disconnection of steel roof deck of Gymnasium due to failure of puddle welds due to uplift pressure.

- long, were disconnected at puddle-weld locations). A few perimeter wall panels fell into the interior of the building, while most were blown away from the building. The loss of the roof decks effectively removed the interior lateral bracing for the tilt-up wall panels of the north, south, and east walls (these walls, however, were still braced on the exterior by the roof systems of the surrounding building sections as described above) and the sole lateral bracing system for the tilt-up panels of the west wall.
2. The disconnection and collapse of the first two bow-string roof trusses (nearest to the west wall). Both of the collapsed trusses sustained lateral, out-of-plane bending, and their disconnections from the top of the tilt-up wall panels appeared to have resulted from shear failure at the embedded seat angles at the ends of each truss (either shear fracture of the welds between the vertical headed studs that were embedded in the concrete or of the welds connecting the joist to the seat angle; see Fig. 3–58 and 3–59).
 3. The collapse of 9 out of 11 tilt-up wall panels of the west wall toward the building's interior (along the tornado's translational direction). These collapsed panels became truly unbraced laterally after the disconnection and loss of the roof decks. The two panels of this wall that did not collapse were end panels that were also laterally supported along their height by bearing against the end panels of the north and south walls. Thus, these two panels did have some lateral support aside from the lateral bracing provided by the roof system, unlike the nine intermediate panels that collapsed.



Figure 3–58. Collapsed bow–string roof trusses and collapsed west wall tilt–up panels in the interior of the Gymnasium.



Figure 3–59. Seat angle welded to end of bow–string roof truss and embedded into top of tilt–up panel got disconnected. Note missing vertical headed studs (4, each 10 in. long), which appeared to have been sheared off from the angle. The three horizontal studs remained connected to the seat angle but pulled out from the concrete.

Possible Failure Sequence:

Calculations using the design information obtained for this building indicated that the roof deck-to-joist connection (by 5/8 in. diameter puddle welds) was the weakest link in the overall uplift resistance of the building (weaker than the joist-to-wall connection). However, the uplift capacity of the roof deck-to-joist connection was well above the required maximum design uplift pressure of 17.3 lb/ft² based on the 90 mph basic design wind speed (thus, this building would not have failed the way it did under a code-level wind event; see Appendix J). The fact that the roof deck-to-joist connection was the weakest link for uplift resistance suggested that the steel roof decks were the first elements to fail, and this failure occurred due to tension failure of the puddle welds. This is consistent with the observed roof deck failure shown in Fig. 3-56 and 3-57. This is also corroborated by videos of the interior of the building recorded by security cameras during the storm, which showed roofing materials, including some roof deck panels, falling into the interior of the building prior to the collapse of the west wall panels.⁸⁵

The failure of the roof deck-to-joist connection and subsequent loss of all the roof decks resulted in nine tilt-up panels of the west wall becoming laterally unsupported and simply overturning at the base in the direction of lateral wind load (west to east). As these panels fell toward the interior of the building, they impacted the first two bow-string roof trusses that were nearest to them (and within their collapse radius), resulting in out-of-plane bending of the trusses, subsequent shear failure of the truss-to-wall connections, and ultimately the collapse of these two roof trusses (see Fig. 3-58, 3-59, and 3-60).

In sum, the sequence of failure of the Joplin East Middle School Gymnasium building was as follows:

1. The roof deck-to-joist connections failed due to tension (uplift) failure of the puddle-weld connections.
2. Nine tilt-up panels (out of 11) of the west wall became unsupported laterally and collapsed due to overturning moment at the base of the wall panels.
3. As these nine panels overturned, they impacted the first two roof joists that were within the walls' collapse radius, causing them to fail also (secondary failures).

The tornado occurred on a Sunday and the Gymnasium was unoccupied at the time of the collapse. Thus, there were no fatalities or injuries associated with the collapse of this building.

Auditorium Building—

The Auditorium was housed in a one-story BTS building with reinforced CMU exterior walls. The approximate plan dimension was 92.6 ft (N-S) by 113.8 ft (E-W), and the mean roof height was 31.6 ft. The floor was a 4 in. RC slab-on-grade with 6 × 6, W1.4 × W1.4 WWF reinforcement.

Design Information:

- MWFRS: The MWFRS comprised two structural subsystems: the roof system that provided lateral bracing for the perimeter reinforced CMU walls, and the perimeter reinforced CMU walls.

⁸⁵ The "Gym NE," "Gym SE," "Gym NW," and "Gym SW" videos were made available by Joplin Schools.

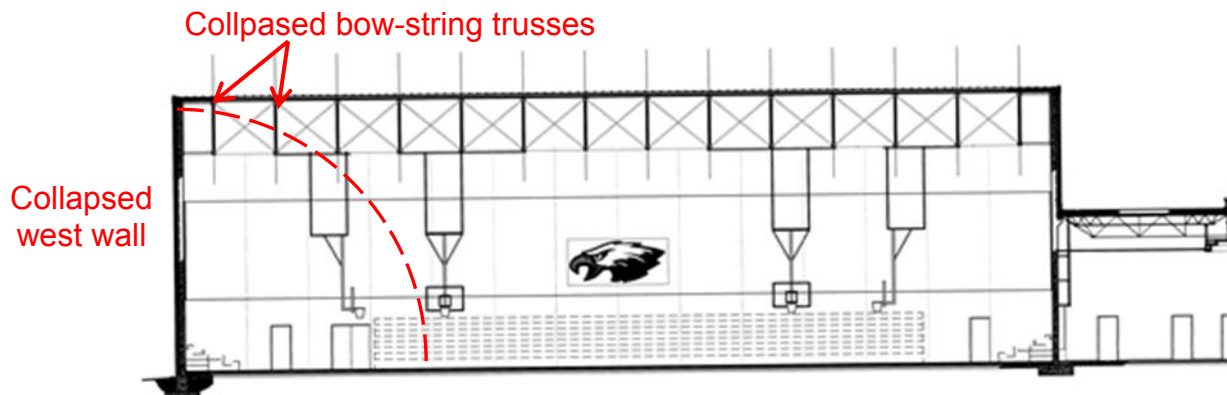

© 2007 Patterson Latimer Jones Brannon Denham (P.L.J.B.D.). Used with permission. Enhancements by NIST.

Figure 3–60. Elevation showing first two bow–string roof trusses and collapse radius of west wall.

- Roof System: This structural subsystem consisted of the following components:
 - Steel roof decks: 1½ in. deep by 36 in. wide, 22–gauge, wide–rib painted (type B) and galvanized acoustic (type BA), three–span continuous steel decks. The decks were fastened to the supporting steel trusses (frame fastener) by 5/8 in. diameter puddle welds using a 36/4 connection pattern. Adjacent deck panels were connected along the side lap (side lap fastener) using #10 Buildex screws with two screws per span.
 - Steel roof trusses: The roof trusses consisted of K series open–web steel roof joists, running in the E–W direction at 5 ft spacing, supported by steel joist girders in the N–S direction. Each joist end was welded to a 5 in. × 1/4 in. × 9 in. steel plate with two 3/8 in. diameter × 4 in. long headed studs that were anchored into the bond beam in the CMU wall.
- Perimeter Walls: These were reinforced CMU walls with 12 in. concrete blocks, stacked bond with horizontal reinforcing at 16 in. on center and with cells filled with grout. Each CMU wall had an overall thickness of 1 ft 9½ in., and included three layers: a single–wythe 12 in. concrete masonry block over 2 in. of rigid insulation over air space over masonry veneer. The walls were connected to the concrete foundation using 4.5 ft long number 6 dowels, placed at mid–depth of the CMU wall at every 2 ft interval, with a 2.5 ft embedment into the wall (3.5 units of CMU). The walls were grouted and reinforced in the vertical direction (at every two masonry units) as well as in the longitudinal direction, including longitudinal reinforcement for the cap beam at the top of the walls. In the interior of the building were two concrete masonry walls that divided the Auditorium into two sections, a stage and an audience section.

- Components and Cladding:
 - Envelope: Exterior masonry veneer.
 - Roof Covering: Single-ply roof membrane over 1/2 in. protection board over 4 in. insulation over steel roof deck.
- Other Features: Similar to the Gymnasium, the Auditorium was surrounded by other sections of the school complex on the north and west sides. Because of that, in addition to being braced laterally by their own roof system, the north and west perimeter walls were also braced on their opposite sides through connections with the roof systems of the adjacent building sections. Thus, of the four perimeter walls, only the east and south walls were truly dependent upon the roof diaphragm as the sole lateral bracing system. These east and south perimeter walls were the ones that collapsed as a result of the tornado, as is discussed below.

Damage and Performance Information:

The Auditorium building sustained total collapse, with damage that included:

1. The disconnection and loss of roof decks in part of the roof, and the collapse of the entire roof system (trusses, steel deck, and roof covering) into the building interior (see Fig. 3-61 and 3-62).
2. Collapses of the east and south perimeter CMU walls, with the south wall collapsed into the building (toward the north) and the east wall collapsed outward, away from the building (toward the east). Similar to the collapsed CMU walls of other BTS buildings in the May 22, 2011, Joplin tornado, the east and south walls failed due to overturning of the entire wall at the wall-to-foundation connections, rather than due to inadequate strength within the CMU walls (see Fig. 3-63).

Possible Failure Sequence:

Calculations using design information obtained for the Auditorium building indicated that the roof deck-to-joist connection (by 5/8 in. diameter puddle welds in a 3/4 pattern) was the weakest link in the overall uplift resistance of the building. However, the uplift capacity of the roof deck-to-joist connection was well above the required maximum design uplift pressure of 17.3 lb/ft² based on the 90 mph basic design wind speed (thus, the roof diaphragm would not have failed under a code-level wind event). The fact that the roof deck-to-joist connection was the weakest link for uplift resistance suggested that the steel roof decks were the first elements to fail, and that their failure was due to tension failure of the puddle welds. The failure of the roof deck-to-joist connections and subsequent loss of roof diaphragm action resulted in the south and east walls becoming laterally unsupported, and they subsequently collapsed due to overturning at the base in the direction of lateral wind load.

In sum, the sequence of failure of the Auditorium building was as follows:

1. The roof deck-to-joist connections failed due to tension (uplift) failure of the puddle-weld connections.

2. The failure of the roof system caused the perimeter CMU walls to lose lateral support on the interior side of the building. While the north and west walls remained braced laterally through connections with the roof systems of adjacent sections, the south and east walls lost their sole lateral support and subsequently collapsed due to overturning.

Figure 3–61.
View from
east of
Auditorium
building.



Figure 3–62. In wreckage of Auditorium, missing roof deck from top of joist—only puddle-weld marks remained.



Figure 3–63. Collapse due to overturning (outward) of east perimeter Joplin East Middle School Auditorium wall after loss of roof diaphragm.

3.2.1.5 Joplin High School

Joplin High School was a building complex that, similar to Joplin East Middle School, comprised several individual but connected buildings of different ages and structural systems. The school, at 2104 Indiana Avenue in Joplin, was oriented in the north–south direction, with the southeast portion in close proximity to the estimated center of the tornado damage path (see Fig. 3–64). This portion of the school complex was subjected to an estimated maximum wind speed of 170 mph \pm 20 mph (EF–4 range, from westerly direction, see Fig. 3–65), and it was the buildings of this portion of the school complex that sustained structural damage and collapsed.

The buildings at Joplin High School had two main structural systems, both typical of building systems in the region: (1) RC frame (two buildings); and (2) BTS with CMU perimeter walls braced by steel roof diaphragms supported by open–web steel roof joists and joist girders. NIST was able to obtain only partial sets of drawings for this facility. The available drawings included those of building sections that were added over time to the school complex (PE Addition building, added in 1989; Multimedia Learning Center in 1997; and TV Studio in 2004). The two RC frame buildings, located at the north end of the school complex, were likely the original school buildings (constructed in the late 1960s). All other sections of the school complex, including the newly added sections identified above, were BTS buildings with CMU walls and steel roof diaphragms as indicated above.

The damage observed at Joplin High School closely followed the pattern of damage observed for buildings of similar construction in the affected area. In other words, the damage to the two RC frame buildings at the north end of Joplin High School followed the same pattern as that observed for the RC .



Figure 3–64. Overview of Joplin High School complex, with estimated center line of Joplin tornado damage path shown in red.

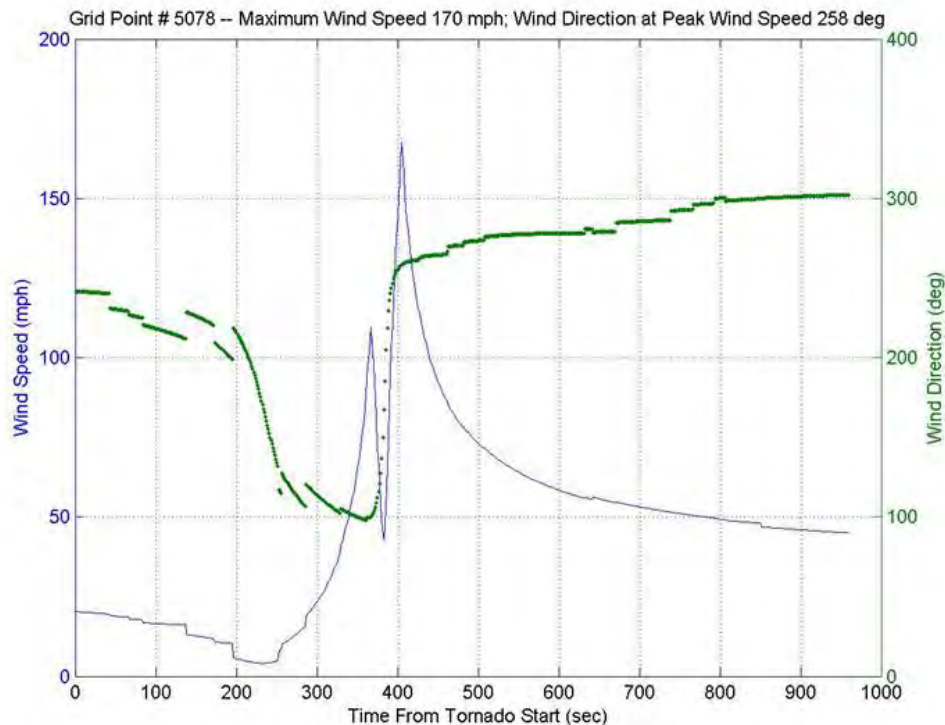

Figure 3–65. Estimated time–history of wind speed and direction at southeast corner (closest to center of tornado damage path) of Joplin High School.

frame building of SJRMC (the West Tower), and the damage to the other, BTS sections of the school followed a pattern similar to that observed for other BTS buildings such as the Walmart. The main damage to the buildings of Joplin High School is described below:

- The two RC frame buildings and other building sections making up the north end of the school complex sustained damage primarily to their vertical building envelopes. These buildings were similar in design, each a three–story structure with one story below ground. Each building’s structural system consisted of an RC frame made of circular columns and rectangular beams, supporting RC floors and composite, concrete–steel roof decks. Between the column lines there were interior, non–load–bearing unreinforced masonry (URM) partition walls. The exterior, vertical envelope consisted of a combination of brick and aluminum stud walls supporting cement–based boards and glass windows. While these buildings sustained no damage to their structural systems, the damage to their envelopes, which included the breakage and collapse of portions of the brick curtain walls and most of the aluminum stud curtain walls, resulted in a complete loss of function in both buildings due to subsequent damage to their interiors (electrical, HVAC systems, etc.). The roof envelopes, made of composite concrete–steel decking, appeared undamaged. Fig. 3–66, 3–67, and 3–68 show views from the exterior of the two RC frame buildings and from the interior of the school building section that linked these buildings; these photographs were taken 3 days after the tornado on May 25, 2011.



Figure 3–66. View from the exterior showing damage to the envelope of one of the RC frame buildings (east building) of Joplin High School.



Figure 3–67. View from the exterior showing damage to the envelope of one of the RC frame buildings (west building) of Joplin High School.



Figure 3–68. Damage and debris in an interior hallway of Joplin High School.

- Several BTS buildings collapsed, including the Gymnasium and Auditorium and smaller buildings with CMU walls and open-joist steel roof truss/steel roof deck diaphragm systems. The Gymnasium and Auditorium had similar structural systems. Both were BTS buildings with long-span, open-joist steel roof trusses and a steel roof deck diaphragm. They were located on the south end of the school close to the estimated center of the tornado damage path.

Following is additional information about the design and performance of the damaged BTS structures.

Gymnasium Building—

The Gymnasium's structural system consisted of a series of steel frames made of wide-flange columns supporting open-web steel joist girders. The columns were supported on a concrete floor slab through bolted connections and enclosed in the CMU perimeter walls. The steel frames supported long-span, open-web steel joist girders and roof joist systems. The building envelope consisted of 22-gauge, wide-rib, three-span continuous steel roof decks (horizontal envelope) and two-layer exterior walls (inner layer made of CMU and outer layer of bricks).

The building sustained a total collapse of both the structural frame and the envelope, including: (a) the disconnection and loss of all steel roof decks; (b) failures of the column-to-floor bolted connections and of the embedded connections between the roof girders and the tops of the CMU walls, which resulted in the collapse of several individual steel columns and of the entire roof system; and (c) the collapse of large portions of the east and west exterior walls due to loss of lateral bracing from the roof system. Fig. 3–69 shows a view of the collapsed Gymnasium building.



Figure 3–69. View from west of the Joplin High School Gymnasium building.

Auditorium Building—

The structural system of the Joplin High School Auditorium consisted of six individual steel frames, each made of open-web deep steel joist girders connected to a wide-flange steel column at each end. Adjacent frames were braced by diagonal steel angles, both vertically and diagonally, and supported a series of smaller open-web steel roof joists. The roof joists in turn supported panels of wide-rib steel roof decks (22-gauge, 36 in. wide, three-span continuous panels). The details of the roof deck-to-joist and joist-to-joist girder connections for the Auditorium were not available due to a lack of design drawings for the building. Besides the steel roof deck and roof covering, the building envelope consisted of exterior walls made of an inner layer of URM wall (non-grouted) and a brick outer layer.

The structural steel frames of the Auditorium building appeared to have sustained only minor damage, with all six frames remaining intact despite the failure of a few lateral braces between them. However, the damage to the roof (lateral bracing) system was significant, with (a) disconnection and complete loss of most of the steel roof deck panels; (b) loss of a large number of the open-web steel roof joists in several spans; and (c) the collapse of most of the exterior URM/brick walls. Fig. 3–70 shows the north side of the Auditorium building.

Other Smaller BTS Buildings—

These single-story BTS buildings typically had CMU walls made of three layers (a partially grouted and reinforced concrete masonry inner layer, a foam insulation middle layer, and an outer brick layer). The top course of the CMU at the top of the wall was grouted to form a continuous cap beam for anchorage of the steel roof joists. The bottom of the CMU wall was anchored (only about 6 in. deep) into the concrete footing with steel reinforcing bars. The typical damage to these buildings included disconnection and loss of panels of the steel roof deck and failure of the connection between the steel roof joists and the CMU

walls, and ultimately, the collapse of a large portion of the exterior CMU walls due to loss of lateral roof bracing (see Fig. 3–71, 3–72, and 3–73)



Figure 3–70. View from north of the Joplin High School Auditorium building.



Figure 3–71. Failure of joist-to-CMU wall connection due to uplift.



Figure 3–72. Collapse of CMU wall due to loss of lateral roof bracing.



Figure 3–73. Short anchorage between CMU wall and concrete footing.

3.2.1.6 Franklin Technology Center

The Franklin Technology Center was a trade school located at 2020 Iowa Street, about 300 ft directly west (across the street) from Joplin High School, and 250 ft north of the center of the tornado damage path. Fig. 3–74 shows an overview of this building, which completely collapsed, as it existed shortly after the May 22, 2011, Joplin tornado. Fig. 3–75 shows the estimated time–history of wind speed, which indicates that the building was affected by a maximum wind speed of approximately 160 mph \pm 20 mph (EF–3 range).

The building was a typical short–span, one–story BTS building with lightly reinforced CMU perimeter walls laterally braced by single–span steel roof systems (open–web steel roof joists supporting wide–rib steel roof decks). The building was rectangular in plan and oriented in the north–south direction, and consisted of two sections of similar design: the original north half, constructed in the late 1960s, and the 1978 south–half addition. NIST was able to obtain only a partial set of the design drawings for this building. Below is design, damage, and performance information for the center.

Design Information:

- Year Built: Original facility (north half), late 1960s; south–half addition, 1978.
- Building Codes: Information not available.
- Design Parameters: Information not available.
- Structural System: The building was a one–story, low–rise BTS with a short, single–span flexible diaphragm steel roof. The structural system comprised two structural components that formed the MWFRS of the building: the roof system; and the perimeter CMU walls.
 - Roof System: The roofing consisted of open–web steel roof joists with 6 ft typical spacing, supporting a built–up roof over 3 in. rigid insulation and 1½ in., 22–gauge, wide–rib, three–span continuous steel roof decks. The roof decks were fastened to the supporting roof joists primarily by puddle welds. However, design information on the roof deck–to–joist fastening pattern was not available. The ends of the roof joists were welded onto embedment plates that were anchored into the bond beam at the top of the perimeter CMU walls with two hooked studs (see Fig. 3–76).
 - Perimeter Walls: The partially grouted CMU exterior walls were covered by a layer of rigid foam insulation and an outer layer of brick veneer. The top course of the CMU walls was grouted and reinforced with two #4 longitudinal steel reinforcing bars to form a continuous horizontal bond beam for anchoring the ends of the roof joists. The CMU walls were also reinforced vertically with #4 reinforcing bars at every 2 ft 8 in. on center. The vertical reinforcements were lapped with #4 reinforcing dowels connecting the CMU walls to the concrete footing.
- Envelope: The building envelope included the roof (built–up roof over rigid insulation) and the walls (brick veneer over rigid foam insulation with openings (doors, windows, and overhead doors) on all four elevations).



Figure 3–74. Overview of damage at Franklin Technology Center, with center line of tornado damage path (in red).

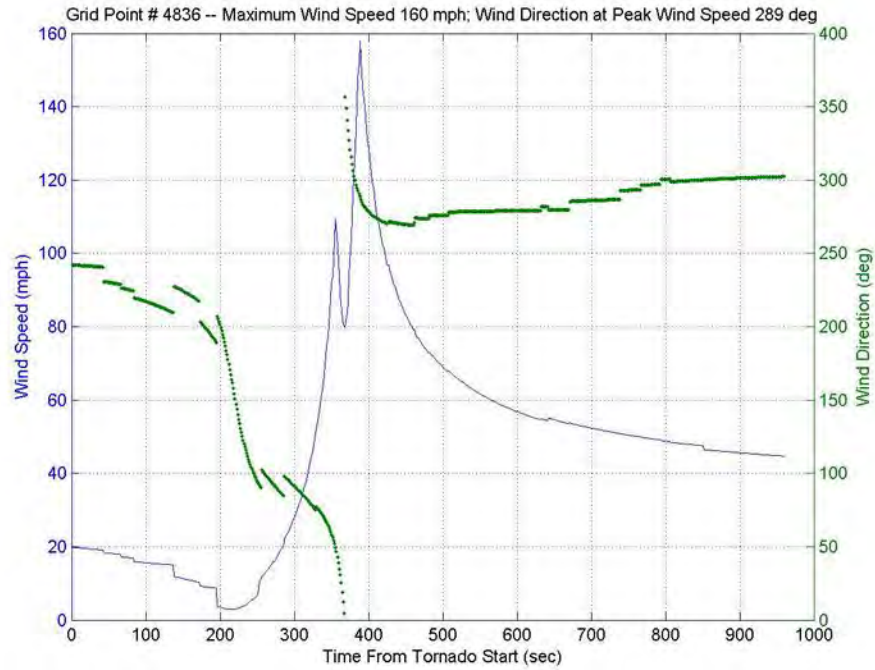

Figure 3–75. Estimated time–history of wind speed at southeast corner of Franklin Technology Center.

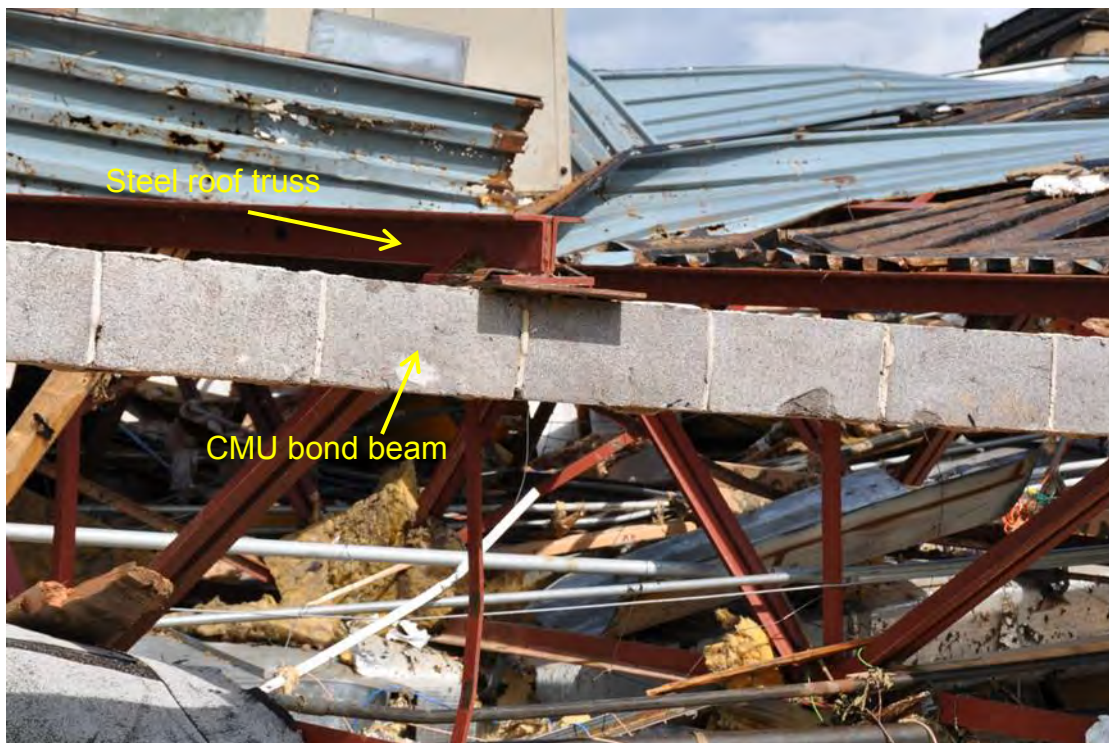

Figure 3–76. Steel roof deck and roof joist connection to CMU wall bond beam.

Damage and Performance Information:

The building sustained complete structural collapse. This collapse was typical of the structural failures observed for other BTS buildings that experienced similarly strong wind uplift in the May 22, 2011, Joplin tornado:

- The entire roof system (roof deck and roof joists) disconnected from the perimeter CMU walls. This involved both (a) the loss of the steel roof deck diaphragm (failure due to tension uplift of the puddle welds), and (b) disconnection of the steel roof joists (while they remained connected to the CMU bond beam) from the remainder of the walls along the mortar joint between the bond beam and the CMU course below the bond beam (the vertical load path in the wall was disrupted at the mortar joint between the bond beam and the CMU course below due to uplift pressure. NIST was not able to determine if the wall's vertical reinforcements were anchored into the bond beam). Thus the bond beam, while remaining continuous horizontally and connected to the roof joists, was separated from the remainder of the perimeter walls due to wind uplift action (see Fig. 3–77).



Figure 3–77. Steel roof joists, with missing roof decks, remained connected to CMU bond beam. Bond beam remained continuous, but was disconnected from the CMU walls along the bond line between the two CMU courses at the top of the wall.



Figure 3–78. Perimeter CMU wall that collapsed after loss of roof lateral bracing (note lack of reinforcing dowels connecting wall to concrete footing).



Figure 3–79. Perimeter CMU wall that collapsed after loss of roof lateral bracing (note lack of reinforcing dowels connecting wall to concrete footing).

- Almost all of the perimeter CMU walls collapsed. It should be noted that while the walls were partially grouted and reinforced, as specified in the available design information for the 1978 south-half addition, close inspection on May 25, 2011, found that there were wall sections (especially in the original 1960s north half) that had no or minimal structural connection between the wall and the RC foundation⁸⁶ (see Fig. 3-78 and 3-79).

There were no reported fatalities or injuries that occurred as a result of the complete structural collapse of the Franklin Technology Center. The facility was closed and there were no occupants at the time the May 22, 2011, Joplin tornado struck.

3.2.1.7 *St. Mary's Catholic Elementary School*

St. Mary's Catholic Elementary School was a typical short-span, one-story BTS building with lightly reinforced CMU perimeter walls laterally braced by single-span steel roof systems (open-web steel roof joists supporting wide-rib steel roof decks), similar to the Franklin Technology Center. It was located approximately 100 ft north of the estimated center of the tornado damage path. Fig. 3-80 shows an overview of the facility, which sustained complete collapse. The estimated maximum wind speed that affected the buildings of St. Mary's Catholic Elementary school was about 165 mph \pm 20 mph from a westerly direction (EF-3 range, similar to the wind speed range estimated for the Franklin Technology Center and Joplin High School; see Fig. 3-81).

The facility consisted of connected building sections, including a section that was built prior to 1994 and an addition built in 1994. NIST was able to obtain only a partial set of the design drawings for the 1994 addition, which showed the following design details for the two primary structural components of the buildings:

- **Steel Roof System:** The roof system consisted of short, single-span, open-web steel roof joists supporting 1 1/2 in., wide-rib, 22-gauge, three-span continuous steel roof decks covered by 3 in. thick rigid insulation and a single layer of asphalt roof covering.
- **Perimeter CMU Walls:** The walls consisted of three layers: an interior structural layer (load bearing) of CMU; a middle layer of 2 in. rigid insulation; and an outer layer of brick veneer. Available drawings for the 1994 addition show that the walls of the addition sections were vertically reinforced with #4 reinforcing bars. The top course of the CMU was grouted and reinforced horizontally with two #4 reinforcing bars to form a bond beam at the top of the perimeter walls. The ends of the roof joists were welded onto steel joist seats that were anchored into the CMU bond beam with steel stud anchors.

The building sustained complete structural collapse similar to that typically observed for this type of construction when it is subjected to strong wind uplift action:

⁸⁶ This is not inconsistent with standard practice. Friction-only connections between walls and footings are accepted for regions with low or no seismic risk. Rotational stability is to be provided for the wall by temporary bracing during the construction phase (prior to connection to the roof system) and by lateral bracing provided by the roof system after connection with the roof.



Figure 3–80. Overview of damage at St. Mary’s Catholic Elementary School, with estimated center line of tornado damage path shown in red.

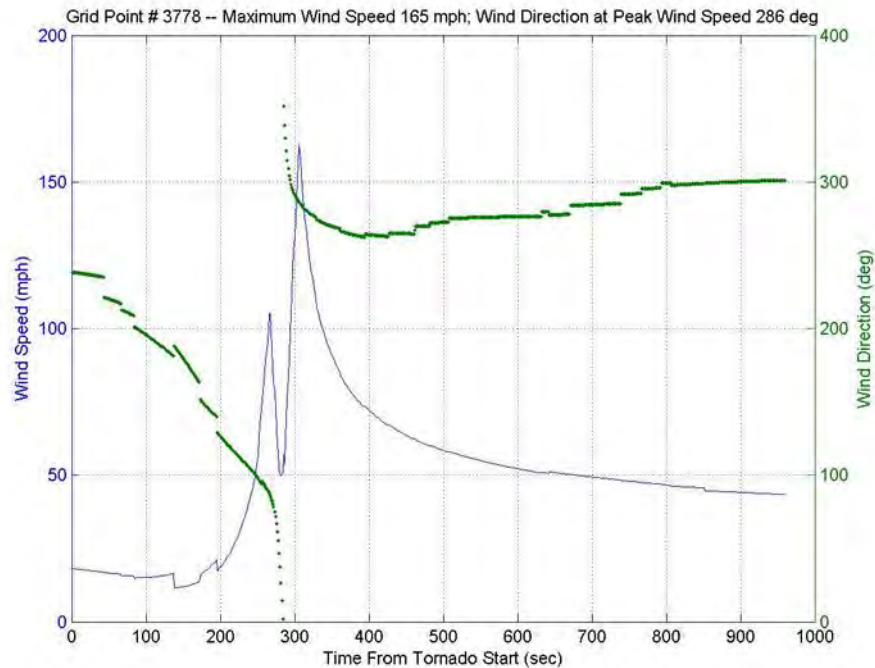

Figure 3–81. Estimated time–history of wind speed affecting the buildings at St. Mary’s Catholic Elementary School.



Figure 3–82. Section of building at St. Mary’s Catholic Elementary school with complete loss of the steel roof system.



Figure 3–83. Section of building at St. Mary’s Catholic Elementary school with collapsed perimeter CMU walls.

- The roof system (roof deck and roof joists) of most of the building sections disconnected from the perimeter CMU walls due to the failure of either roof deck–to–joist connections (failure of puddle welds) or roof–joist–to–wall connections (vertical load path in the wall was not continuous vertically, with the mortar joint between the top bond beam and the next CMU course being the weak link, and the bond beam, while remaining continuous horizontally, disconnected from the remainder of the perimeter walls under wind uplift action; see Fig. 3–82).
- Almost all of the perimeter CMU walls collapsed due to the loss of the roof (and sole lateral bracing) system (see Fig. 3–83).

There were no reported fatalities or injuries that occurred as a result of the complete structural collapse of St. Mary’s Catholic Elementary school.

3.2.1.8 Summary of Performance of Critical Facilities and High–Occupancy Buildings

The followings are findings that pertain to the performance of critical facilities and high–occupancy buildings during the May 22, 2011, Joplin tornado. Several of the findings listed below are also

consistent with findings regarding responses of critical and institutional facilities during the May 20, 2013, tornado in Moore, Oklahoma (NIST SP 1164, 2013):

- Buildings in general, including the NIST–surveyed critical facilities and high–occupancy buildings described in the above section, are not designed to withstand tornado hazards (extreme wind speeds and windborne debris), and accordingly there are no building code requirements for such hazards. Most buildings in the area damaged by the May 22, 2011, Joplin tornado, were subjected to wind speeds that well exceeded the non–tornadic wind design requirements of the building codes applicable to them. Windborne debris contributed significantly to building damage, and is also not considered as a hazard in building design.
- Surveyed critical facilities (SJRMC) and high–occupancy buildings (Walmart, Home Depot) were not able to provide life safety protection to occupants.
- Engineered buildings of affected critical and high–occupancy facilities surveyed by NIST that had a lateral load resisting system that did not depend on bracing from the roof system for lateral stability (such as steel and concrete moment frame buildings) withstood the tornado without structural collapse. Those that relied on a roof diaphragm of reinforced concrete or composite concrete and steel deck (such as steel braced frame buildings with that type of roof) also withstood the tornado without structural collapse. Those that relied on the bracing of a less robust, light weight steel roof system for lateral stability (such as Box–Type System (BTS) buildings) were prone to structural collapse.
- Structural collapse of NIST–surveyed BTS buildings of critical and high–occupancy facilities began with failure of the roof system due to wind uplift (failure of roof deck–to–joist or joist–to–wall connection), leading to loss of lateral bracing for perimeter walls and causing them to collapse by rotation at the base due to lateral load. Available design information showed the roof connections of these buildings to be adequate for code–level design wind pressures, making it unlikely that these buildings could have failed at code–level winds.
- NIST–surveyed BTS buildings that sustained total structural collapse have two common design features that increase their vulnerability to collapse in a tornadoes:
 - Long span, light–gauge steel roof systems, and
 - Friction–only wall–to–footing connection (currently accepted practice for areas with low or no seismic risk)
- All NIST–surveyed engineered buildings of affected critical and high–occupancy facilities sustained significant damage to the building envelopes and interior due to the combination of wind pressure, impact of windborne debris, and the subsequent water intrusion.
- Failure of the envelopes of buildings at SJRMC, leading to loss of protection and subsequent extensive damage of the building interior (including electrical distribution and fixtures, water and gas pipes, HVAC system and ductwork, elevator system and elevator shaft enclosure), was the primary cause for the complete loss of functionality of this critical facility, despite the robust structural system that could withstand the tornado without structural collapse.

- The majority of impact-resistant windows on the fifth floor (Behavioral Health Unit) of the West Tower of SJRMC remained intact, whereas most regular dual pane insulated windows at SJRMC were broken when exposed to the same tornado hazards.
- While there was no direct evidence that roof aggregates contributed to any injuries or fatalities in Joplin, there was evidence that roof aggregate contributed to envelope damage of SJRMC's buildings and surrounding structures, thus adding to the tornado debris hazard and the potential for injuries or fatalities.

3.2.2 Commercial Buildings

3.2.2.1 Ozark Center for Autism

The Ozark Center for Autism, located at 2411 South Jackson in Joplin (Ozark Center), was approximately 300 ft north of the estimated center of the tornado damage path (also about 300 ft to 350 ft northwest of the demolished Greenbriar Nursing Home; see Fig. 3–1 in Sec. 3.1.2 and Fig. 3–84 below). The building was affected by a maximum wind speed estimated at approximately 160 mph \pm 20 mph from a westerly direction and, while it did not collapse structurally, sustained significant damage to the building envelope and interior. Figure 3–85 shows the estimated time–history of the wind speeds that affected the Ozark Center.

The building comprised two rectangular sections: Main and Physical Education (PE). The Main section, 153 ft 8 in. \times 49 ft 8 in. in plan and oriented in the north–south direction, was a three–story CIP RC braced frame structure. The PE section, also rectangular with a 65 ft 4 in. \times 74 ft plan dimension, was a two–story steel moment frame structure supporting a steel roof system (open–web steel joists and wide–rib steel deck panels). The PE section was connected to the east wall of the Main section. It is unknown when the building was first designed and constructed, but it was remodeled in 2007. The remodeling involved changes in interior layout with removal of old partition walls and addition of new ones. NIST was able to obtain a partial set of architectural drawings for the 2007 remodel. The sections below summarize the design, damage, and performance information relating to this building.

Design Information:

- Year Built: Original building, unknown; remodeled in 2007.
- Building Code: Remodeled based on IBC 2000.
- Design Parameters: 90 mph basis design wind speed.



Figure 3–84. Overview of damage to the Ozark Center for Autism and surrounding buildings, with estimated center line of tornado damage path shown in red.

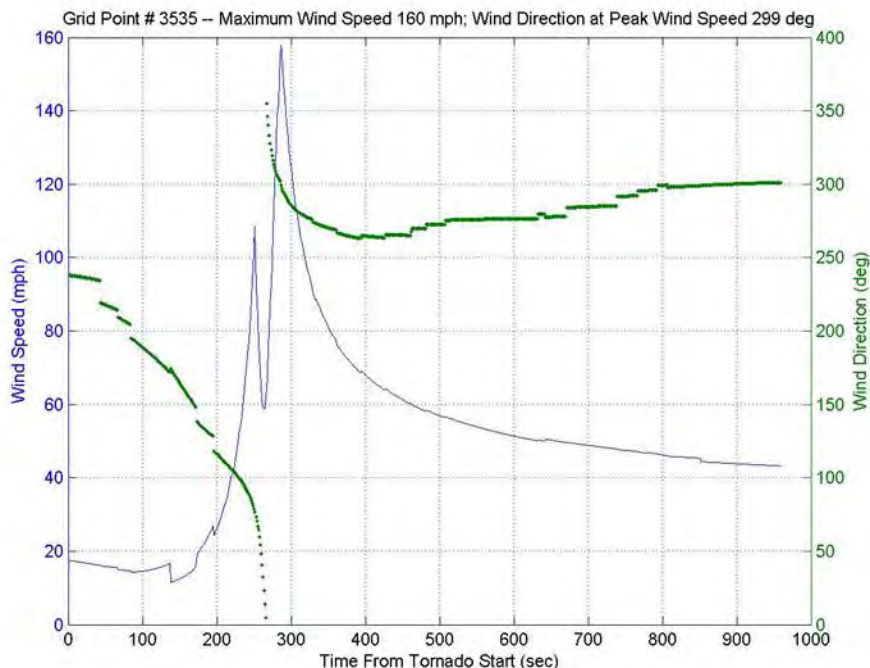

Figure 3–85. Estimated time–history of wind speed and direction at the Ozark Center.

- Structural System:
 - Main Section: The MWFRS was a three–story CIP RC braced frame, comprising (1) square RC columns (two exterior column lines and two interior column lines in the north–south direction, dividing the building into 3 bays in the east–west direction) supporting (2) perimeter deep RC spandrel beams and (3) RC flat slabs for floors and roof. The frame was braced by an RC shear wall (on the east elevation, bracing in the north–south direction) as well as by CMU walls surrounding the stairwell (bracing in the east–west direction). See Fig. 3–86.
 - PE Section: The MWFRS was a two–story steel moment frame supporting steel trusses and open–web steel roof joists that were covered by wide–rib steel roof decks (see Fig. 3–87).
- Building Envelope:
 - Main Section: Vertical envelope consisted of (1) CMU infill walls between exterior columns, clad with I–shaped steel furring strips that provided backing surfaces for light–gauge exterior steel panels, and (2) dual–pane insulating windows on all four elevations. Roof envelope was a CIP RC slab, covered with a mixture of hot asphalt and gravel.



Source: FEMA MAT.

Figure 3–86. Ozark Center for Autism building (viewed from the southeast).



Figure 3–87. Interior view of the physical education section of the Ozark Center showing structural system with roof truss–column moment connection and open–web roof joist and wide–rib steel roof deck.

- PE Section: Vertical envelope consisted of brick infill walls for the first story and insulating glass windows with steel framing for the second story. Roof envelope comprised wide-rib steel roof decks, covered with a single layer of thermal insulation, and ballasted with a hot asphalt and gravel mixture (the gravels were not loose-laid).
- Other Feature: The Ozark Center building had two designated “Areas of Refuge” located in the stairwells of the Main section of the building (see Sec. 3.3.3.1).

Damage and Performance Information:

The building sustained significant damage to the building envelope, and subsequently significant damage to all electrical/HVAC/plumbing systems and contents in the building interior. However, there was no apparent damage to the MWFRS of the Main section (CIP concrete braced frame) and only minor damage to MWFRS of the PE section (steel moment frame), despite the building’s close proximity to the center of the tornado damage path and the wind infiltration allowed by the breached envelope (causing increased wind uplift pressure). As a result, neither section of the building collapsed structurally, but the entire facility sustained complete loss of operation. The damage to the building envelope included:

- Loss of part of the roof system (steel roof decks only, not the supporting roof joists) and all vertical envelopes (insulating windows and window frames) on all three wind-exposed sides of the PE section due to wind uplift pressure (disconnection and loss of steel roof decks, see Fig. 3-88).
- Damage to or loss of all vertical envelopes on all four wind-exposed sides of the Main section, including failures of all light-gauge exterior steel panels and window glass glazing (see Fig. 3-89).

The minor structural damage involved deformation of the perimeter steel beam at the northeast corner of the PE section (see Fig. 3-88). This was likely due to debris impact and resulted in no significant reduction to the lateral load capacity of the MWFRS of this section.

The overall performance of the Ozark Center building (damage to building envelope, but no damage to the MWFRS despite wind pressure exceeding design conditions, resulting in complete loss of functionality) is very similar to the performance observed for RC and steel frame buildings elsewhere (e.g., the towers and medical office buildings of SJRMC (see Sec. 3.2.1.1)).

As indicated above, the building had two designated areas of refuge located in the stairwells protected by CMU wall enclosures (see Sec. 3.3.3.1). NIST does not have information regarding occupancy at the time of the May 22, 2011, Joplin tornado, so it is not known whether there were survivors in the building. There were no fatalities reported at this building as a result of the tornado.



Figure 3–88. Significant damage to the envelope and minor damage to the MWFRS of the physical education section of the Ozark Center building, including (1) loss of part of steel roof decks, (2) loss of all insulating windows and steel frames on all wind-exposed sides, and (3) deformation of steel beam (likely due to debris impact).



Figure 3–89. Typical damage to the Ozark Center building envelope (broken window glazing, missing window frames, and torn exterior steel panels).

3.2.2.2 St. Paul's United Methodist Church

St. Paul's United Methodist Church, located at 2423 West 26th Street, was at the periphery of the heavy damage path. The southernmost portion of the facility was about 700 ft north of the estimated center of the tornado damage path (see Fig. 3–90), and was affected by an estimated maximum wind speed of about 130 mph \pm 20 mph from a west–northwesterly direction (see Fig. 3–91).

The church comprised several light SF buildings, including the pre–engineered steel building at the southernmost portion of the facility that was used as the Mass Hall. It was this building that sustained the most significant damage during the May 22, 2011, Joplin tornado, while the other buildings sustained mostly minor damage. NIST conducted a damage survey of the Mass Hall to study the performance of this type of construction (pre–engineered steel buildings) under tornado hazards. Due to the unavailability of design information for the church buildings, the performance information below is based exclusively on engineering information collected during the field damage survey conducted shortly after the May 22, 2011, Joplin tornado.

Pre–engineered steel buildings are designed in conformance with criteria promulgated by the American Institute of Steel Construction, the Steel Building Manufacturers Association, and the American Welding Society, and typically consist of sets of primary rigid steel frames. Members of the primary frame (columns and rafters) are typically designed with tapered built–up plate sections with the most steel in the areas of highest stress, and are prefabricated to allow for ease of connection and erection. Adjacent primary frames are braced diagonally in the roof and vertical planes using steel cables. Secondary members, including roof purlins, are typically light–gauge, cold–formed Z– or C–shaped members. Pre–engineering allows for the design of lighter overall systems through steel usage that is more efficient than in conventional steel construction. Pre–engineered steel buildings are mostly one–story structures, but can have two stories.

The pre–engineered steel Mass Hall building of St. Paul's United Methodist Church consisted of five sets of primary rigid frames, each made of tapered built–up steel columns and steel rafters joined by bolted connections. The frames were braced with steel cables and supported cold–formed, Z–shaped purlins and light–gauge standing seam steel roof decks that were attached to the purlins with sheet steel screws. The cable–braced primary frames represented the MWFRS of the building. The building's vertical envelope consisted of steel–stud frames clad with sheet steel panels that were attached to the steel–stud frames using sheet steel screws. See Fig. 3–92, 3–93, and 3–94.

The building sustained significant damage to the envelope (disconnection and loss of all sheet steel roof decks and all vertical sheet steel wall panels, as well as the collapse of part of the steel–stud exterior frames), but only limited damage to the MWFRS (braced primary rigid frames). As a result, the building did not collapse, but sustained complete loss of functionality due to the loss of the envelope and subsequent damage to the building interior. NIST does not have information regarding the church's occupancy at the time of the May 22, 2011, Joplin tornado. There were no reported fatalities or injuries at this facility, however.



Figure 3–90. Overview of damage at St. Paul’s United Methodist Church and surrounding areas, with the estimated center line of the tornado damage path shown in red.

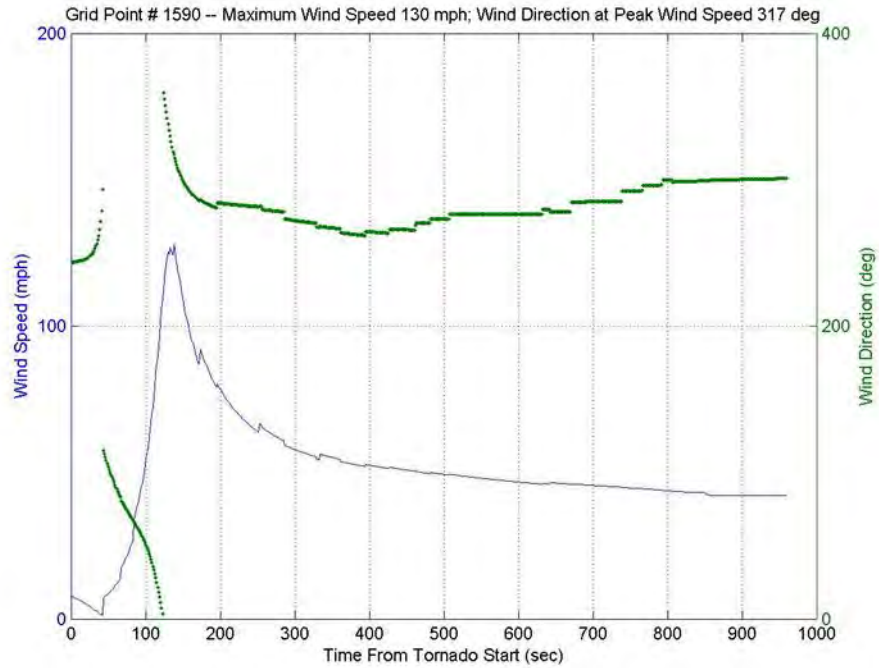

Figure 3–91. Estimated time–history of wind speed affecting the Mass Hall of St. Paul’s United Methodist Church.



Figure 3–92. View from east of the damaged, pre–engineered steel Mass Hall building of St. Paul’s United Methodist Church.



Figure 3–93. Tapered rafter sections with bolted connection and roof purlins of St. Paul's United Methodist Church.



Figure 3–94. Damage to envelope of St. Paul's United Methodist Church.

3.2.2.3 Ramesh Shah Ophthalmology Center

The Ramesh Shah Ophthalmology Center building, located at 1703 West 30th Street, was about 1,500 ft south of the estimated center of the tornado damage path and approximately 500 ft southwest of SJRMC. The building was at the southern periphery of the swath of heavily damaged areas (see Fig. 3–95). The time–history of wind speed estimated from the wind field model (see Fig. 3–96) indicated that the Ramesh Shah building was affected by a maximum wind speed of 115 mph \pm 20 mph (EF–2 wind speed range), which is close to or just above the wind speed that the structure should have been able to resist without collapse or major damage.

NIST was able to obtain partial design information for this building. These data, combined with damage information obtained from NIST’s field survey following the tornado, indicated that the Ramesh Shah building was a two–story structure built in 1993 with a plan dimension of 53.6 ft \times 60 ft. The first story (partially below ground) had 12 in. RC exterior walls. The second story, at ground level, was a pre–engineered steel rigid frame building, with one primary frame made of tapered steel columns and rafters at the center of the building (similar to St. Paul’s United Methodist Church), and two perimeter frames made of I–shaped columns and C–shaped, cold–formed steel beams. The frames supported a roof system that consisted of cold–formed, Z–shaped steel roof purlins covered with standing–seam steel roof decks. The first floor consisted of open–web K series bar joists supporting a composite RC floor (3 in. thick) on steel decks. The three pre–engineered rigid frames of the second story were diagonally braced with steel cables in the roof plane. See Fig. 3–97, 3–98, and 3–99. The steel columns were cast and anchored into the top of the RC wall of the first story (see Fig. 3–100). The building vertical envelope consisted of synthetic stucco siding over rigid insulation and combinations of tempered and dual–pane insulating window glazing. The roof envelope was standing–seam steel roof decking.

As most of the first story of this building was below ground (and shielded from significant wind effects), it was the pre–engineered steel frame second story that was most affected by the tornado. And similar to the performance of the Mass Hall building of St. Paul’s United Methodist Church (also a pre–engineered steel building), the second story of the Ramesh Shah building sustained significant damage to its envelope (disconnection and loss of all standing–seam steel roof decks, all synthetic stucco siding, and the window glazing and frames), but only limited damage to the MWFRS (braced primary rigid frames). The complete loss of the roof and wall envelopes likely relieved the pressure on the primary frame members, allowing them to remain standing during the tornado. As a result, the MWFRS of the building (pre–engineered steel frames) did not collapse, but the building sustained a complete loss of functionality due to the loss of the envelope and subsequent significant damage to the interior. NIST does not have information regarding occupancy at this building during the May 22, 2011, Joplin tornado. There were no reported fatalities or injuries at this building due to that tornado.



Figure 3–95. Overview of damage at the Ramesh Shah Ophthalmology Center, with the estimated center line of the tornado damage path shown in red.

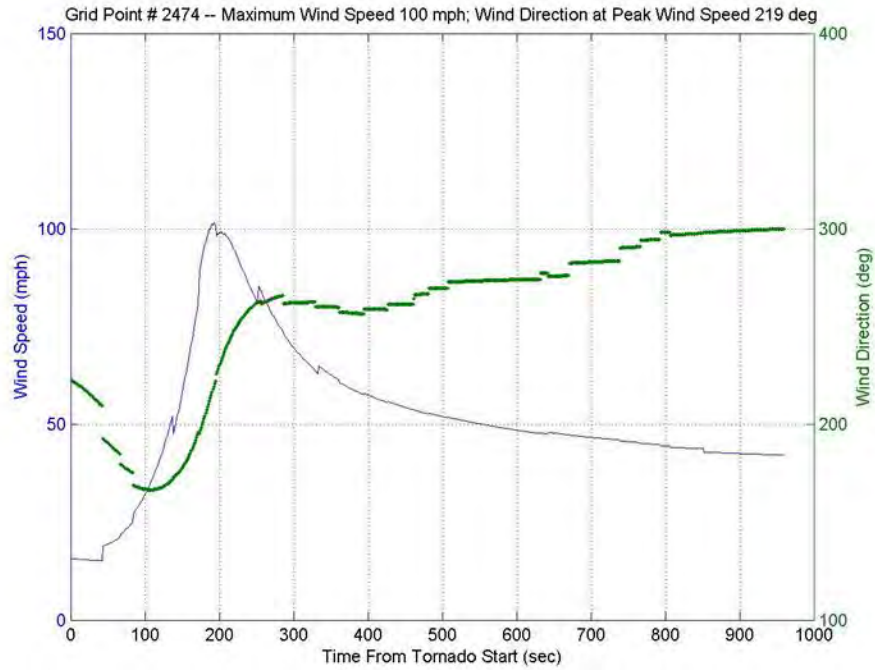

Figure 3–96. Estimated time–history of wind speed and direction at the Ramesh Shah Ophthalmology Center.



Figure 3–97. Ramesh Shah Ophthalmology Center viewed from the southwest.



Figure 3–98. Ramesh Shah Ophthalmology Center viewed from the east–southeast.



Figure 3–99. Close up view of the Ramesh Shah Ophthalmology Center showing connections and cable bracing of the pre–engineered steel frames



Figure 3–100. Close up view of the Ramesh Shah Ophthalmology Center showing connection between the pre-engineered steel frame with the concrete wall below

3.2.2.4 Summary of Performance of Commercial Buildings

The followings are findings that pertain to the performance of commercial buildings during the May 22, 2011 Joplin tornado:

- Buildings in general, including the NIST-surveyed commercial buildings described in the above section, are not designed to withstand tornado hazards (extreme wind speeds and windborne debris), and accordingly there are no building code requirements for these hazards. Most commercial buildings in the area damaged by the May 22, 2011, Joplin tornado, were subjected to wind speeds close to or greater than the ultimate wind-resisting capacity anticipated in the building codes applicable to them. Windborne debris contributed significantly to building damage, and is also not considered as a hazard in building design.
- Engineered commercial buildings surveyed by NIST that had a lateral load resisting system that did not depend on bracing from the roof system for lateral stability (such as steel and concrete moment frame buildings) withstood the May 22, 2011, Joplin tornado without structural collapse. Those that relied on the bracing of a light steel roof system for lateral stability (such as Box-Type System (BTS) buildings) were prone to structural collapse.
- PEMB commercial buildings surveyed by NIST sustained significant damage to their envelope, but no structural collapse of the primary rigid steel frame.

3.2.3 Residential Buildings

The residential buildings in the tornado-affected area were primarily of wood-frame or combinations of lightly reinforced CMU and wood-frame construction. The overall performance of residential buildings in Joplin during the May 22, 2011, tornado, especially the one- and two-family residential constructions, was similar to that typically observed in other tornadoes. That is, it was primarily a function of two factors: proximity to the tornado; and the quality of construction. However, even among buildings in the same area (i.e., with similar proximity to tornado hazards) with similar construction quality, degrees of damage can vary significantly due to changes in the tornado's intensity as it moves through the area.

Given that there were 7,411 residential buildings that were either damaged or destroyed in the May 22, 2011, Joplin tornado, it was not practical to review the performance of all single-family residential structures. Consequently, NIST's approach was to review the performance of a few selected multi-family residential buildings in detail (Greenbriar Nursing Home and Mercy Village Apartments), and review the performance of single-family homes in a general, statistical context. The aim was to make representative observations that might be useful for the development of best practices and future design strategies for more tornado-resistant residential construction.

As was discussed in Sec. 3.1.5, given the City of Joplin's history of timely and proactive code adoption and enforcement, it is reasonable to assume that both the older and more recently constructed residential buildings in Joplin were built in accordance with the building codes then in effect (since 2003, the codes in use have been the 2000 ICC International Residential Code for One- and Two-Family Dwellings (IRC) for one- and two-family homes and the 2000 IBC for multi-family residential buildings). These building codes have provided prescriptive guidance that can be described as component-based (rather than system-based) for framing individual roofs and walls (e.g., stud spacing, nailing schedules, bracing or sheathing materials for in-plane shear), constructing roof-to-wall connections (e.g., use rafter or truss tie-downs with prescribed strength for roof assemblies subject to wind uplift pressure which, by default, could be satisfied using common nails in regions with 90 mph wind), and designing wall-to-foundation connections (e.g., use sill plates anchored by bolts into slab/foundation at 6 ft spacing). Current codes also stipulate that "a continuous load path shall be provided to transmit uplift forces from the rafter and truss ties to the foundation," but provide no specific guidance on how this is to be achieved.

Fig. 3-1, 3-2, and 3-3 depict the levels of damage sustained by all buildings affected by the May 22, 2011, Joplin tornado, including residential structures, based on the Pictometry[®] database (color codes for damage conditions include green (light damage), yellow (medium damage), orange (heavy/totaled), and red (demolished)). As can be seen from these figures, the damage tends to be more severe for residential buildings closer to the estimated center of the tornado damage path. Table 3-5 shows a general correlation between the age of residential buildings, which were divided into three age groups (before 1950, 1950-2000, and 2001-present) and the four damage conditions.

Table 3–5. Distribution of tornado–affected residential structures by level of damage sustained and year built.

Year Built	Level of Damage				Total	% of Total Rated as Heavy/Totaled or Demolished
	Light	Medium	Heavy/Totaled	Demolished		
Before 1950	1616	289	426	863	3194	40.4
1950–2000	1569	375	617	1070	3631	46.5
2001–Present	175	38	39	54	306	30.4
All Years	3,360	702	1,082	1,987	7,131 ⁸⁷	43

As shown in Table 3–5 above, 43 percent (3,069) of the 7,131 residential buildings affected by the May 22, 2011, Joplin tornado sustained damage classified as heavy/totaled or demolished. This percentage did not vary significantly among the age groups, so there was no discernible relationship between the level of damage sustained and the age of the structure. Thus, it can be said that both older and newer residential structures performed similarly during the Joplin tornado.

Following are general descriptions of the classifications used for residential damage:

- Light: Visible damage to building envelope, including loss of small portion of roof covering
- Medium: Loss of small portion of roof system, including roof covering and roof structural sheathing, and damage to some roof trusses
- Heavy/Totaled: Loss of significant portion of (or entire) roof system, exposing the building interior to weather damage and compromising the lateral bracing system for walls, but walls remain standing
- Demolished: Roof and walls collapsed; entire structure might be shifted off of the foundation and collapsed

An illustration of how homes in a small neighborhood were classed is provided in Fig. 3–101. The performance of selected multi–family buildings is discussed in Sec. 3.2.3.1. General observations on the typical performance of single–family residential structures are presented in Sec. 3.2.3.2.

3.2.3.1 Multi–Family Residential Buildings

There were several multi–family residential buildings that were affected by the May 22, 2011, Joplin tornado. NIST selected for damage surveys two properties that were representative of the types of construction and damage found among this group of facilities: Greenbriar Nursing Home; and Mercy Village Apartments.

⁸⁷ There were 280 damaged residential buildings that had no age information. The total number of residential buildings that sustained tornado damage was 7,411 (7,131 + 280).

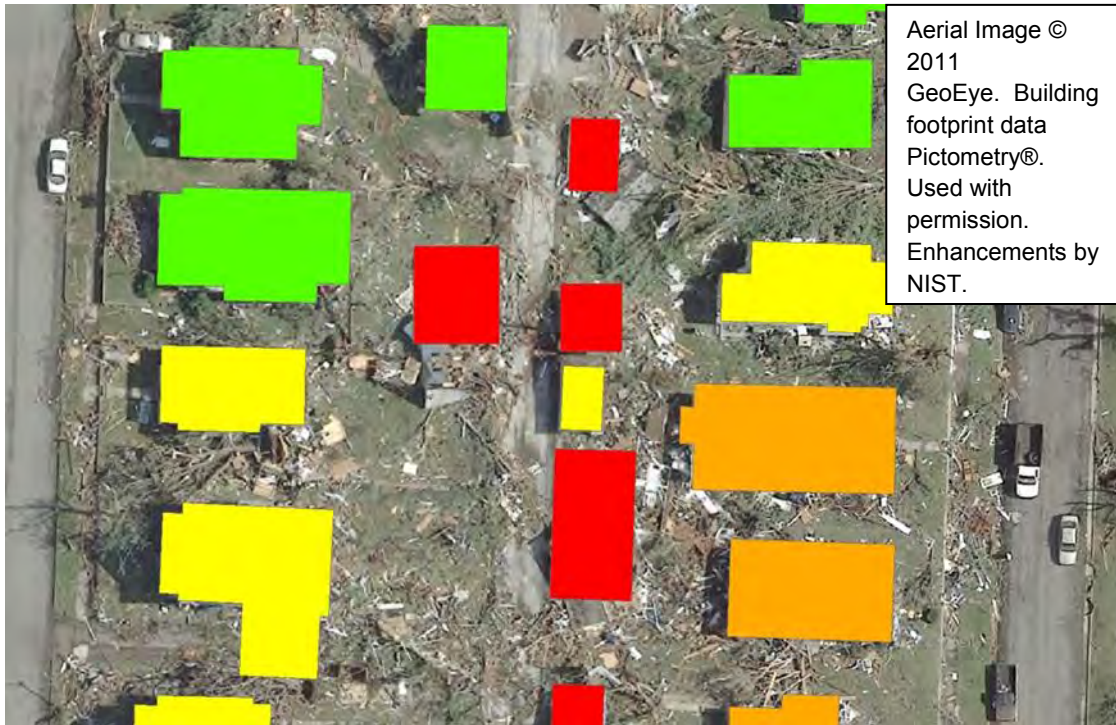

Figure 3–101. References for Pictometry® database damage classifications and coding: light (green), medium (yellow), heavy/total (orange), and demolished (red).



Even though the Greenbriar Nursing Home was a health care facility by function (and thus could also have been discussed among the critical facilities and high-occupancy buildings addressed in Sec. 3.2.1), it is discussed here because of its construction type, which was typical of multi-family residential construction in the Joplin area. The Greenbriar Nursing Home was an unreinforced CMU wall structure with sheathed wood roof trusses. The Mercy Village Apartment building was a platform framed construction with 2 × 4 wood frames, wood floors, and wood roof trusses. These two buildings also represented the two ends of the damage spectrum; the Greenbriar Nursing Home was completely demolished while Mercy Village sustained only minor envelope damage. Descriptions are provided below of the design of these two buildings, the environmental conditions that affected them on May 22, 2011, and their performance.

Greenbriar Nursing Home—

The Greenbriar Nursing Home, located at 2502 South Moffet Avenue (in the same vicinity as the Ozark Center and St. Mary’s school) (Greenbriar), was at the center of the estimated tornado damage path (see Fig. 3–102). The facility was constructed in the mid–1960s, likely based on either BOCA BBC/1960 or 1965, and comprised a rectangular core section, oriented in the east–west direction, that was connected to four rectangular wing sections, oriented in the north–south direction. The maximum wind speed affecting this facility, estimated based on wind field model results for a point just to the west of the building, was about 165 mph ± 20 mph (EF–3 range, see Fig. 3–103). The Greenbriar was directly east (downstream) of several residential neighborhoods that were totally demolished (see Fig. 3–1 and 3–102). Due to this juxtaposition, the Greenbriar Nursing Home was likely affected by significant amounts of wind-borne debris in addition to the strong tornado wind speed. The entire facility (core and four wing sections) collapsed completely in the storm.

NIST surveyed this facility but was unable to obtain any design information. Information from the on-site survey indicated that the building had one story, was made primarily with unreinforced (or very lightly reinforced vertically) CMU exterior walls supporting wood roof trusses, and did not have a basement. The roof trusses, sheathed with 4 × 8 plywood panels and covered with standing-seam, light-gauge steel roof covering, were connected to the top of the CMU walls by common nails driven into a 2x wood top plate. The unreinforced CMU walls were minimally connected to the concrete footing.⁸⁸ This type of construction, with minimal or no vertical reinforcement within the CMU walls, was vulnerable to damage by wind uplift action due to the lack of continuity in the vertical load path. The building interior was partitioned into multiple units for long-term housing of patients with non-load-bearing 2 × 4 wood frames. NIST does not have information regarding whether any areas in the building were formally designated as refuge areas prior to the tornado. The damage survey indicated that there were no areas in the interior of the facility that were structurally hardened and therefore more suitable than other areas for use as designated safe or refuge areas.

Figures 3–104, 3–105, and 3–106 show different views of the damage at Greenbriar Nursing Home, which included:

- Disconnection and complete loss of all roof systems in all building sections (core and four wings), with the 2 × 4 wood roof trusses, 4 × 8 plywood sheathing, and all standing-seam

⁸⁸ This is not inconsistent with standard practice. Friction-only connections between walls and footings are accepted for regions with low or no seismic risk.



Figure 3–102. Overview of the Greenbriar Nursing Home, shown in relation to the estimated center line of the tornado damage path (red line).

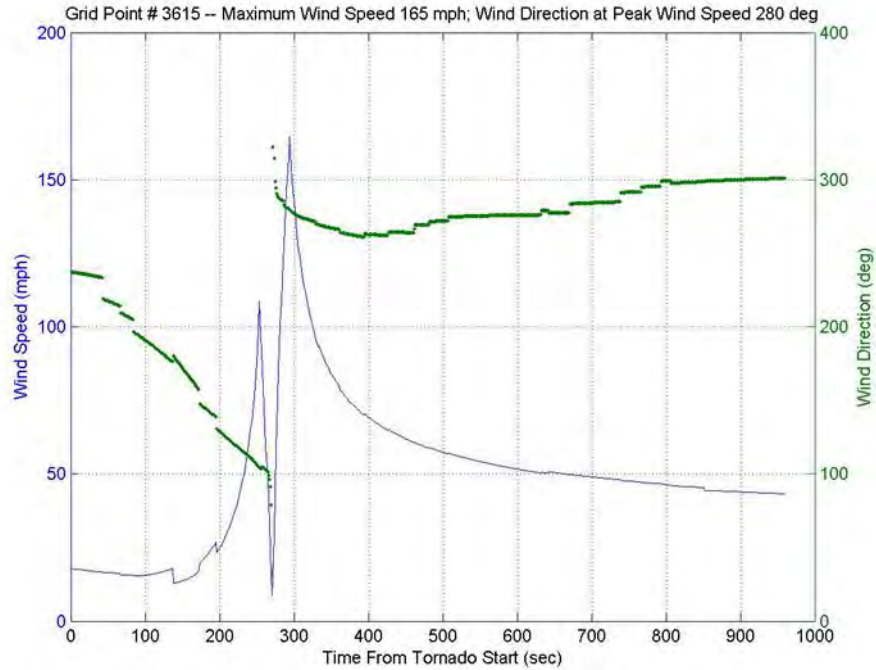

Figure 3–103. Estimated time–history of wind speed affecting the Greenbriar Nursing Home.



Figure 3–104. Collapsed Greenbriar Nursing Home (viewed from the east) with missing roof system and collapsed exterior CMU walls. Note debris from building materials as well as other sources (automobiles) in all interior areas of the facility.



Figure 3–105. Collapsed Greenbriar Nursing Home.



Figure 3–106. Collapsed Greenbriar Nursing Home (viewed from the north) showing the portion of the north wing’s exterior wall that did not collapse.

steel roof coverings disintegrated into small pieces (this further contributed to the wind-borne debris hazard, in contrast to steel roof joist systems, where the joists may have gotten disconnected from the wall but in general stayed together as a unit). A significant amount of the roof and building debris either fell into the building interior or scattered around the vicinity of the facility.

- Complete collapse of almost all the exterior CMU walls, except for a few small sections along the north ends of the north wings. The collapsed CMU walls mostly disintegrated into either individual CMU blocks or very small clusters of a few CMU blocks (reflecting the lack of within-wall reinforcement).

As shown in the figures, the interior of the entire facility was covered with building materials and other wind-borne debris, which presented an extremely hazardous environment to the occupants on May 22, 2011. As discussed in Chapter 4, there were 19 fatalities (mostly impacted-related), out of a total of approximately 95 occupants, at the Greenbriar as a result of the tornado and structural collapse. Reportedly, many of the patients were placed in the hallway at the center of the east-west core section of the facility. This was in order to keep them as far away from the windows as possible. While this was the only logical option, the inner hallway of this facility was structurally no different from any other areas within the facility, and the general construction of the Greenbriar building, with its lack of continuity in the vertical load path, offered little protection against the direct impact of the May 22, 2011, Joplin tornado.

Mercy Village Apartments—

Mercy Village Apartments, located at 1148 West 28th Street in Joplin, was approximately 1,200 ft south of the estimated center of the tornado damage path and about 1,000 ft directly east of the south complex of SJRMC. It was at the southern periphery of, but not in close proximity to, the demolished residential neighborhoods to its northeast and therefore was likely to have been affected to a lesser degree by wind-borne debris impacts compared with the Greenbriar Nursing Home (see Fig. 3-107, note the undamaged, green vegetation immediately south of the building, which indicated lower wind speed and less severe tornado hazards in the vicinity of Mercy Village Apartments). The estimated maximum wind speed that affected the Mercy Village Apartments building was about 125 mph \pm 20 mph (EF-2 to EF-3 wind speed range, see Fig. 3-108). The building was a three-story platform wood-framed structure with an elevator, L-shaped plan configuration (18, 216 ft² footprint and 51.6 ft building height), and a total of 66 senior living apartment units. The sections below summarize the design, damage, and performance information related to this building.

Design Information:

- Year Built: 2003.
- Building Code: 2000 IBC.
- Design Parameters: Basic wind speed, 90 mph; exposure category, C; importance factor, 1.0.



Figure 3–107. Overview of the Mercy Village Apartments, shown in relation to the estimated center line of the tornado damage path (red line). SJRMC is located to the west (left) of the apartments.

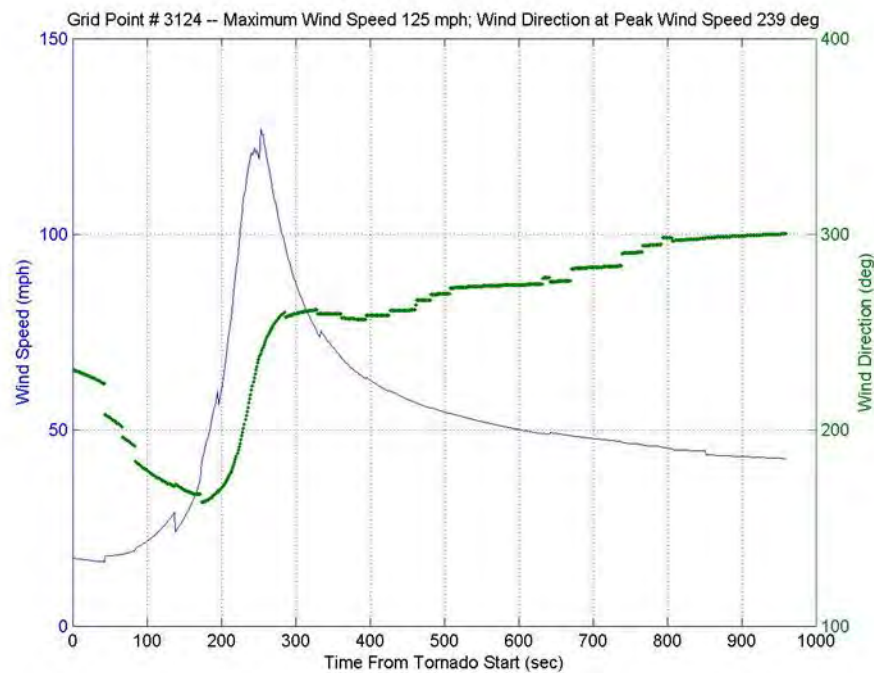

Figure 3-108. Estimated time-history of wind speed affecting the Mercy Village Apartments.

- Structural System:
 - Roof System: 2 × 4 wood roof trusses sheathed with plywood panels. The ends of each roof truss were connected to the top board of the double top plate of the third-floor exterior bearing walls with hurricane tie-downs (generally referred to as “hurricane clips,” see Fig. 3-109). Note that the hurricane tie-downs are installed on the inside of the wall while the sheathing that provides the transfer of loads to the wall studs is located on the outside of the wall. Hurricane tie-down manufacturer data suggests that this configuration reduces the effectiveness of the hurricane tie-downs by 50 percent unless straps are added to the inside of the wall framing to tie the double top plate to the wall studs.
 - Walls:
 - First-floor exterior load-bearing walls: wood frame with double 2 × 4 studs at 16 in. on center.
 - Second- and third-floor exterior load-bearing walls: wood frame with single 2 × 4 studs at 16 in. on center.

All exterior load-bearing walls were braced with structural sheathing (7/16 in. × 4 ft wide structural plywood panels attached with 8d common nails) and diagonal steel straps on the outside face, and 5/8 in. gypsum wallboard on the inside face. In addition to the required fastening with common nails, the exterior load-bearing walls



Figure 3–109. Hurricane tie–downs connecting wood roof trusses to load–bearing wood–frame wall.

below and above the second and third floors were tied to the floor trusses between them using pre–loaded hold–downs (Simpson PHD2–SDS3 hold–downs) and steel straps. And the first–story walls were secured to the concrete foundation with $\frac{1}{2}$ in. diameter \times 4 in. embedment adhesive anchors at 32 in. on center. The hurricane roof tie–downs, pre–loaded wall hold–downs, and embedment foundation anchors provided a structural wood–frame system with a continuous vertical load path (see Fig. 3–110).

- Floor: 18 in. deep wood floor trusses spaced at 16 in. on center with $\frac{3}{4}$ in. plywood subflooring.
- Foundation: 4 in. concrete slab and concrete foundation footings of various sizes.
- Envelope:
 - Roof: Asphalt shingles over single–layer bituminous felt over plywood sheathing over wood roof trusses.
 - Walls: Combination of brick veneer and horizontal cement–board lap siding over a wood frame. Glazing consisted of both insulating and $\frac{1}{4}$ in. tempered glass windows on all exterior sides.

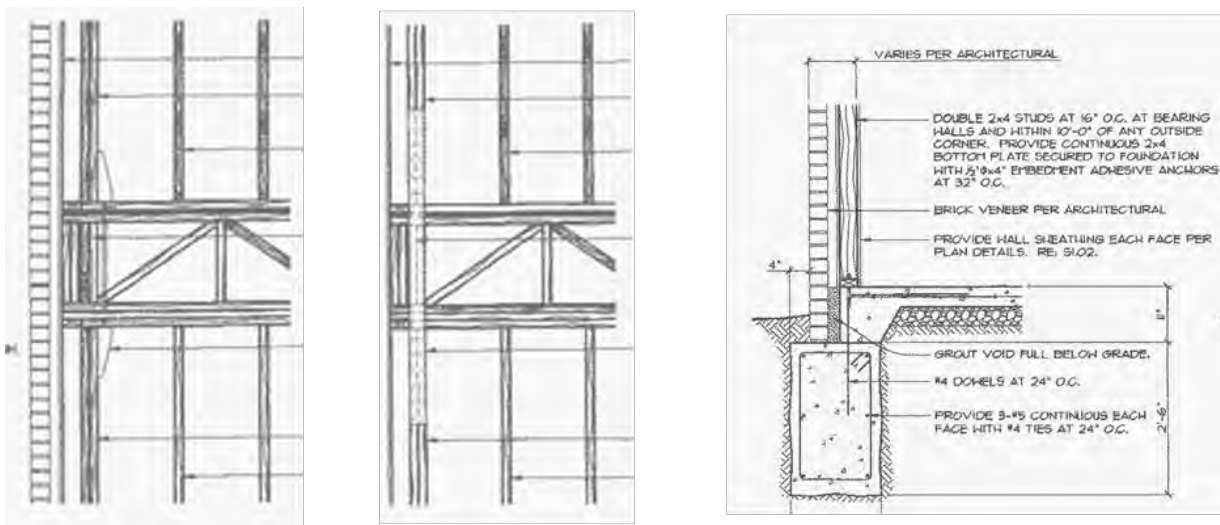

© 2013 Ron Reid. Used with permission.

Figure 3–110. L to R, pre-deflected wall hold-down, steel strap, and wall anchor.

Damage and Performance Information:

While the tornado hazards (wind speed and wind-borne debris) that affected the Mercy Village Apartments building on May 22, 2011, were estimated to be less severe than those that affected the Greenbriar Nursing Home (125 mph \pm 20 mph versus 165 mph \pm 20 mph, and a less significant wind-borne debris field given the surrounding areas and relative proximity to the tornado damage path; see Fig. 3–107), these hazards still exceeded the conditions that the building was designed to resist (90 mph basic wind speed, corresponding to roughly 115 mph ultimate wind speed, with no provisions for wind-borne debris impact). Despite these hazards, the damage at Mercy Village Apartments was limited mostly to the building envelope, with almost no damage to the structural system or its load-carrying ability (at wind speeds in this range, strong wood-frame structures have been observed to have their roof system either damaged or disconnected due to wind uplift). This good structural performance can probably be attributed in part to the use of more robust connections, typically required only for residential wood-frame buildings in hurricane-prone regions, between the primary structural systems of the building (roof-to-wall, wall-to-wall between floors, and wall-to-foundation, thus ensuring continuity of load path from roof to foundation). The damage to the building envelope, shown in Fig. 3–111 and 3–112, included:

- Damage to window glazing on all sides of the building (both insulating glass and tempered glass), likely due to wind-borne debris impacts (there were windows near the broken windows that were not damaged, suggesting that wind pressure was likely not the cause of the broken windows).
- Damage to the exterior brick veneer, cement-board sidings (missing, broken boards), and roof covering (lost roof shingles).



Figure 3–111. Mercy Village Apartments, viewed from the north, with envelope damage (sidings, window glazing, roof covering).



Figure 3–112. Damage to the building envelope of the Mercy Village Apartments.

- Loss of small sections of wall and roof plywood sheathing between the third floor and roof (see Fig. 3–112).
- Reported damage to the interior due to water infiltration where there were damaged windows.

While it is not known how many occupants were present during the May 22, 2011, Joplin tornado, it is known that the facility was occupied. However, there were no reports of fatalities or injuries occurring at this building.

3.2.3.2 Single-Family Residential Buildings

The correlations among environmental conditions (in terms of EF polygons), degree of damage (light, medium, heavy/totaled, and demolished), and construction age (implicitly construction quality) for the residential structures affected by the May 22, 2011, Joplin tornado are shown shown in Table 3-6.

Statistics from the table above show that, in general:

- Age of construction was not a statistically significant factor in terms of performance of residential buildings. In other words, newer and older residential buildings sustained similar degrees of damage when exposed to similar tornado hazards.
- More than 90% of residential buildings sustained at least heavy/totaled damage when exposed to the EF-4 wind speed range. This ratio dropped to more than 80% for residential buildings exposed to the EF-3 wind speed range, slightly more than 50% for areas affected by the EF-2 wind speed range, less than 20% for EF-1 areas, and about 4% for EF-0 areas. These ratios suggested that about 50% of residential buildings, built based on current and past building codes, would be able to survive an EF-2 tornado (with medium damage, at most). The wind speed range associated with an EF-2 tornado is 111–135 mph (in 3 second gusts), which is close to or above the wind speed that would be expected to cause failure of a building designed for the current basic design wind speed of 90 mph for tornado prone areas.

The structural failures observed among residential buildings predominantly involved disconnection of component structural systems (roof-to-wall and wall-to-foundation connections), with roof disconnections causing most of the damage (see Fig. 3–113 to 3–118). This indicated that structural failure tended to be due to a lack of robustness in the connections between residential structural components (i.e., the inability to maintain a continuous vertical load path from roof to foundation), rather than to the structural capacity within the components. More robust uplift-resistant connections between primary structural components can help keep the roof system connected to the supporting walls (and thus continuing to provide lateral bracing for the walls, keeping them from collapsing due to lateral wind loads) and thereby reduce the severity of damage to individual residential buildings. Keeping more affected buildings intact can reduce wind-borne debris, the potential for injuries and fatalities, and overall damage, which can enhance a community's resilience to tornadoes.

To achieve this improved performance, *overall system integrity* (i.e., primary structural components of residential systems remain connected, albeit damaged) up to a certain wind speed range (for example, a maximum wind speed in the EF-3 range), should be stipulated as a required design objective.

Table 3–6. Correlation between degree of damage and age of residential construction, by severity of wind speed.

<i>Residential Buildings in the EF–4 Damage Area</i>						
Year Built	Degree of Damage					
	Light	Medium	Heavy/Totaled (H/T)	Demolished (D)	TOTAL	% H/T or D
Pre–1950	7	4	72	343	426	97.4
1950–2000	5	18	93	392	508	95.5
2001–present	0	2	3	15	20	90
					954	
<i>Residential Buildings in the EF–3 Damage Area</i>						
Year Built	Degree of Damage					
	Light	Medium	Heavy/Totaled (H/T)	Demolished (D)	TOTAL	% H/T or D
Pre–1950	42	50	181	273	546	83.2
1950–2000	32	53	180	403	668	87.3
2001–present	1	3	9	23	36	88.9
					1250	
<i>Residential Buildings in the EF–2 Damage Area</i>						
Year Built	Degree of Damage					
	Light	Medium	Heavy/Totaled (H/T)	Demolished (D)	TOTAL	% H/T or D
Pre–1950	190	111	110	138	549	45.2
1950–2000	174	120	207	219	720	59.2
2001–present	2	6	6	3	17	52.9
					1286	
<i>Residential Buildings in the EF–1 Damage Area</i>						
Year Built	Degree of Damage					
	Light	Medium	Heavy/Totaled (H/T)	Demolished (D)	TOTAL	% H/T or D
Pre–1950	643	95	45	73	856	13.8
1950–2000	923	183	127	84	1317	16.0
2001–present	34	7	1	1	43	4.6
					2216	
<i>Residential Buildings in the EF–0 Damage Area</i>						
Year Built	Degree of Damage					
	Light	Medium	Heavy/Totaled (H/T)	Demolished (D)	TOTAL	% H/T or D
Pre–1950	661	18	12	16	707	4.0
1950–2000	436	15	7	12	470	4.0
2001–present	45	1	0	0	46	0.0
					1223	

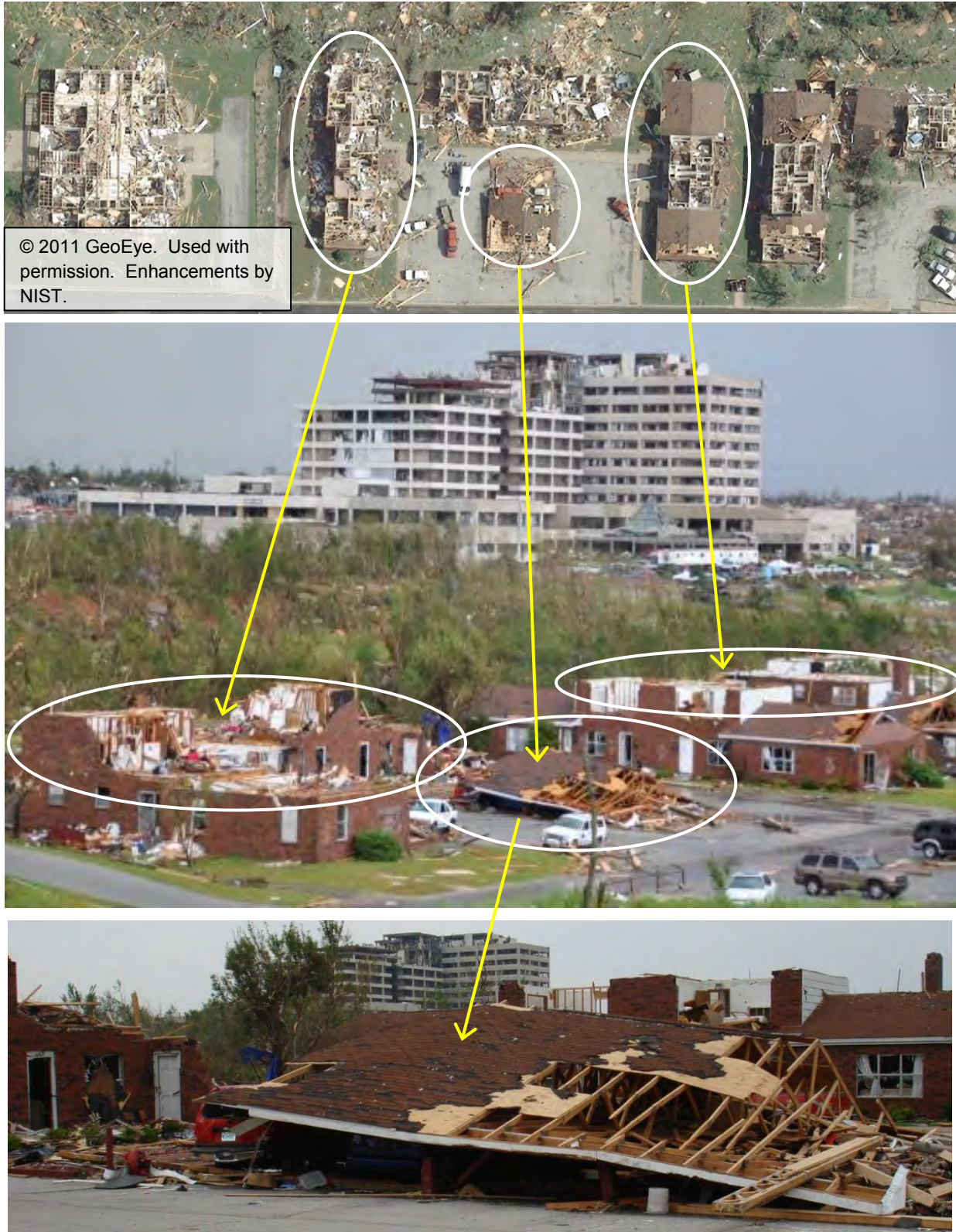

Figure 3–113. Residential failure due to disconnection of entire roof system (roof-to-wall connection failure due to wind uplift).

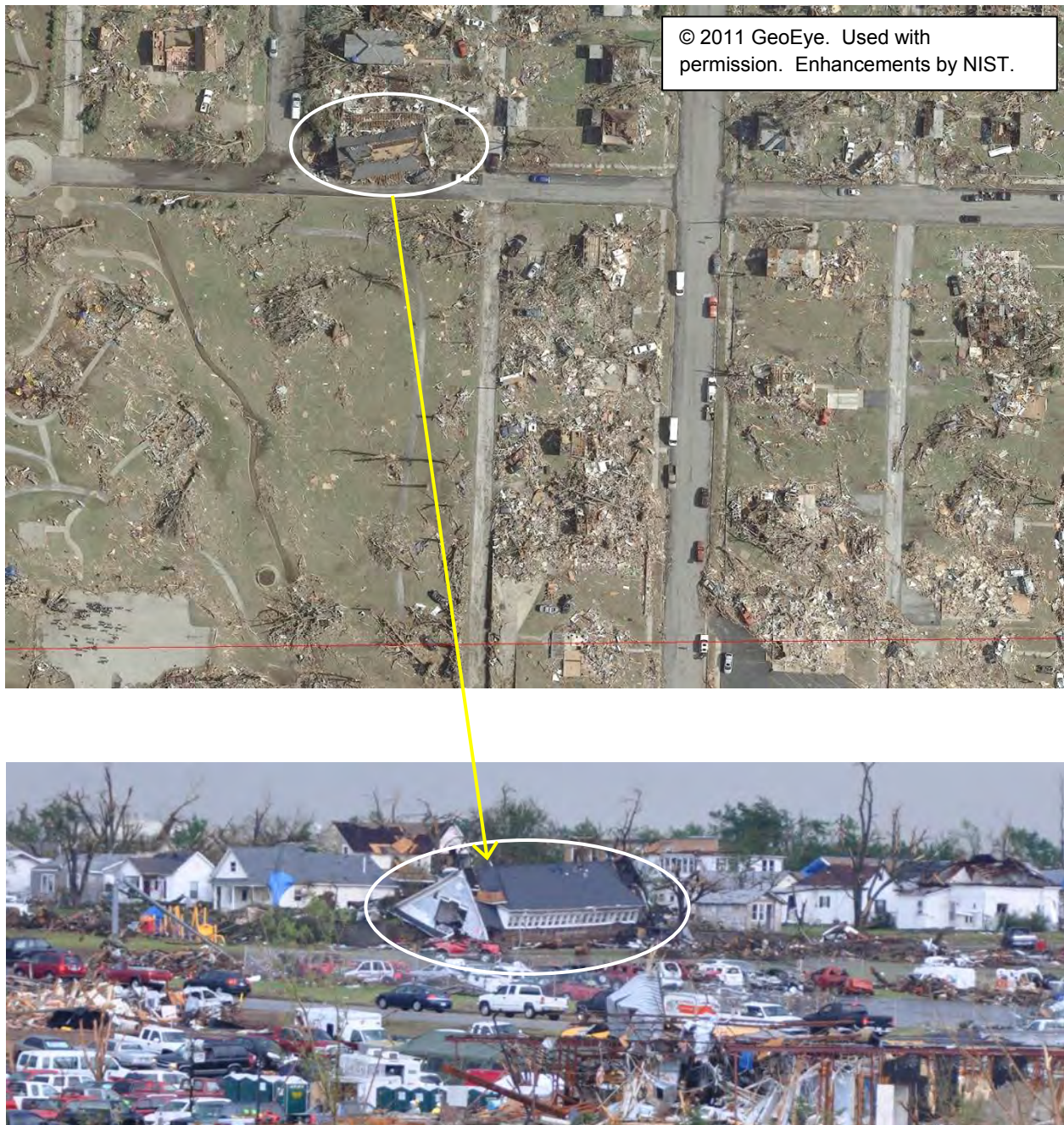

Figure 3–114. Failure of first-story-to-foundation wall connection. Entire roof and first floor shifted off of lower story (directly north of SJRMC).



Figure 3–115. Disconnection and loss of entire roof system.



Figure 3–116. Typical roof-to-wall connection damage.



Figure 3-117. Typical wall-to-foundation connections.



Figure 3-118. Typical damage to residential dwelling envelope.

3.2.3.3 Summary of Performance of Residential Buildings

The followings are findings that pertain to the performance of residential buildings during the May 22, 2011, Joplin tornado:

- Residential buildings in general are not designed to withstand tornado hazards and accordingly there are no building code requirements for it. The majority of residential buildings in the area damaged by the May 22, 2011, Joplin tornado, were subjected to wind speeds close to or above the speed that would be expected to cause failure of structures designed to the non-tornadic wind design requirements of the building codes applicable to them. Windborne debris contributed significantly to building damage, and is also not considered as a hazard in residential building design.
- Of the 161 total fatalities, 135 (or 83.8%) were building-related, and more than half of the building-related fatalities (74 of 141, or 52.5%) occurred in residential buildings. Of the buildings that were damaged, 7411 were residential and 553 were non-residential. About 43% of the residential buildings sustained at least heavy/total damage condition. This resulted in \$1.228 billion in insured losses for non-residential property and \$0.552 billion insured losses for residential property.
- Failure of residential wood-frame buildings predominantly involved failure of the connections between structural components, rather than of the components themselves (roof, wall, and floor) with the majority of these failures involving disconnection of the roof from the walls and walls from the foundation. This indicates lack of robustness in the connections and consequently in the continuity of vertical load path from roof to foundation.
- Better structural performance in one of the NIST-surveyed multi-story wood frame residential buildings in Joplin may be attributed, in part, to a more complete load path from the roof to the foundations.

3.3 PERFORMANCE OF DESIGNATED SAFE AREAS AND SHELTERS

Safe sheltering against tornado hazards requires the availability of hardened physical facilities and an effective operating procedure. Hardened facilities can range from stand-alone public shelters or safe rooms, which are specially designed and constructed to criteria that are well above the minimum code requirements of the national model codes (IBC, NFPA 5000, and IRC) for wind loading, to designated areas of refuge within an existing facility that, while not specifically designed and constructed, are deemed structurally more suitable than other areas in the facility and are accessible for use by building occupants for sheltering.

Public shelters/safe rooms are typically required to be constructed and operated in accordance with the requirements of the local authority having jurisdiction (AHJ). The criteria most often used for construction are based on FEMA 361 (2008), *Design and Construction Guidance for Community Safe Rooms*, or the ICC-500 (2008) *Standard for the Design and Construction of Storm Shelters*. Storm shelters/safe rooms built to these special, above-code requirements can offer life-safety protection against tornado hazards.

Designated areas of refuge in a facility, also commonly known as “best available refuge areas,” are areas within a facility that are likely to offer the greatest protection for occupants from a tornado compared with other areas in the facility. These areas are not specifically designed to criteria above the minimum code requirements for wind loading, and, while occupants in these areas are comparatively less likely to be injured or killed than occupants in other areas of the facility, best available refuge areas are not expected to offer life–safety protection against tornado hazards. Selection of in–facility best available refuge areas is recommended to be done in consultation with a qualified architect or engineer. Voluntary guidance for such selections is provided in FEMA P–431, *Selecting Refuge Areas in Buildings* (2009), and typically involves three steps: (1) determining the size of the refuge area (can vary by the age and any special needs of the occupants); (2) identifying the strongest portion(s) of the building by reviewing the design drawings and inspecting the facility (recommended to be performed by a qualified architect or engineer, primarily based on his or her experience and subjective judgment and not on any special detailed structural modeling due to the multitude of possible failure modes, the complex nature of tornadoes, and the variations in types of construction); and (3) assessing the refuge site to identify any potential nonstructural hazards (falling trees, power poles, etc.).

At the time of the May 22, 2011, Joplin tornado, the City of Joplin did not have or operate any public shelters/safe rooms, nor did it require the construction of safe rooms in residential or commercial facilities. Interviews with a FEMA Region VII Hazard Mitigation Assistance Specialist⁸⁹ indicated that there were three FEMA–funded public shelters/safe rooms in adjacent Newton County (south of Jasper County). These included a 1,388 ft² shelter for 248 occupants in the Village of Stella; a 17,030 ft² shelter for 2,500 occupants at Crowder College in Neosho; and a 14,039 ft² shelter for 2,711 occupants at the Seneca R–7 School in Seneca. None of these public shelters/safe rooms were affected by the May 22, 2011, Joplin tornado.

Within the City of Joplin, based on information that NIST obtained through field damage surveys, subsequent NIST interviews, and data sharing with other organizations, NIST found that there were in–facility designated safe areas in several institutional and commercial high–occupancy buildings, as well as in–home shelters in residential buildings (in single homes, but not in apartment buildings) in the tornado–affected areas. High–occupancy facilities that had designated refuge areas and/or tornado emergency response procedures included commercial buildings (Walmart, Home Depot), schools (Joplin East Middle School, Joplin High School), and health care facilities (SJPMC, Greenbriar Nursing Home). In residential buildings, since most did not have a basement that could offer some protection in tornadoes (only about 16 percent of the residential buildings that sustained damage had either a crawl space or full basement, according to the Pictometry[®] database, the balance were of slab–on–grade construction), some residents had installed in–home concrete or steel tornado shelters.

The effectiveness of a designated area of refuge is limited by the type of construction in which it is located, and current voluntary guidance for the selection of in–facility safe areas (FEMA P–431) relies upon the experience and subjective judgment of qualified architects or engineers (which can vary widely). Not surprisingly, then, the performance of designated safe areas during the May 22, 2011, Joplin tornado varied. Information on in–facility refuge areas in high–occupancy facilities and on selected in–home shelters is presented in the following sections in the form of case studies for use in evaluating the effectiveness of such refuges and associated sheltering practices.

⁸⁹ Laura Josephson, personal communication, May 25, 2011.

3.3.1 Commercial High–Occupancy Facilities

3.3.1.1 Designated Refuge Area at Walmart

Through a review of design drawings and interviews with survivors, NIST was able to identify the designated refuge area in Walmart Store #59 (called the Site-to-Store or Layaway area of the store) where employees and shoppers were directed to shelter on May 22, 2011, as part of the store's emergency plan (see Walmart evacuation details in Chapter 4). This designated refuge area (or best available refuge area) was in the back of the store, adjacent to the east perimeter CMU wall and near the only fire-exit door on that wall (see Fig. 3–119). Design drawings indicated that the design loads for the roof structure of the Layaway area included an additional 5.0 lb/ft² downward pressure to account for the weight of hanging bicycles stored in the stockroom. The area was enclosed with 18- and 20-gauge steel stud (6 in. wide) interior partition walls with gypsum wall boards on both sides. There were wood shelving units along the interior partition walls, and a service counter as this area was used as a layaway and stockroom area. Thus, this area was near a hard perimeter wall (within the collapse radius of the east perimeter CMU wall) and the only fire exit at the back of the store. The design drawings indicated that this was not a hardened area and structurally there was little difference between this designated safe area and most other interior areas, except for the Tire and Battery Operation (TBO) area in the service bay outside the south perimeter CMU wall. NIST does not have information on how this area was selected as the designated refuge area for this facility (including whether a qualified architect or engineer was consulted or a structural evaluation was performed).

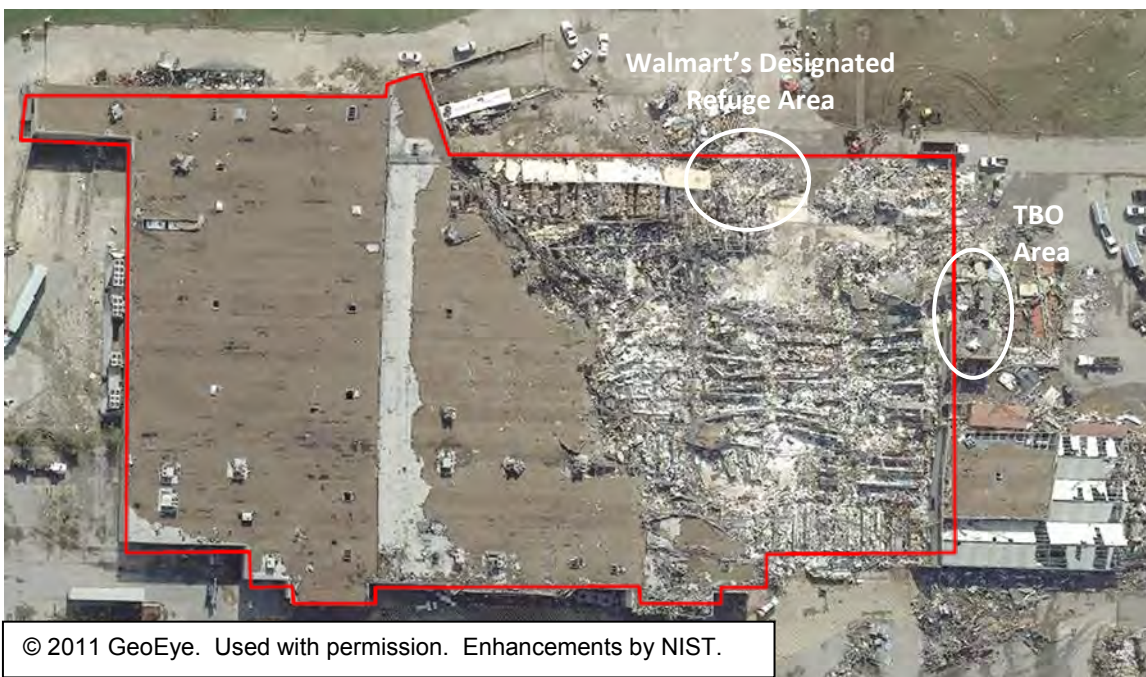

Figure 3–119. Aerial photo showing the locations of the designated refuge area and TBO area in the Walmart store a drawing containing the refuge area. .

As a result of the May 22, 2011, Joplin tornado, the roof system of the south half of the Walmart failed, with many steel roof trusses collapsing into the interior of the building, including into the designated refuge area. The east exterior CMU wall also collapsed inward onto the designated refuge area (see Sec. 3.2.1.2). There were three fatalities and an unknown number of injuries at the store. It is not clear exactly where the three fatalities occurred; however, some of the injuries were confirmed through survivor interviews to have occurred in the designated refuge area. Accounts from survivors also indicated that the wood shelving units and counter in the refuge area might have acted as a dead stop that kept some of the roof trusses from collapsing completely to the floor, thus creating air space between the trusses and the floor and keeping some occupants of the refuge area from being more seriously injured. This fortuitous development, rather than protection designed into the refuge area, might have helped to reduce the number of casualties at the store. Overall, however, the designated safe area in Walmart Store #59 did not provide safe refuge for occupants in this particular tornado event.

NIST's review of structural drawings and its field damage survey also suggested that the TBO area, based solely on structural considerations, might have provided a better refuge than the designated area (see Fig. 3-119). The TBO area, located behind the automobile service bay, was surrounded by hard CMU walls on all sides (the south perimeter CMU wall, which was laterally braced on both sides of the wall, and interior CMU partition walls on other sides). This area sustained envelope damage but did not sustain structural collapse. This observation highlights the need for structural evaluation in selecting best available refuge areas by a qualified architect or engineer.

3.3.1.2 Designated Refuge Area at the Home Depot

NIST was able to confirm the location of the Home Depot's designated refuge area and review the store's emergency response procedure (the procedure is described in Chapter 4) through interviews with representatives of the store. According to the information obtained by NIST, customers and store employees (associates) were directed, in accordance with the store's emergency procedure, to the designated refuge area located in the Training Room in the back of the store. This Training Room/designated refuge area was located along the east perimeter wall, in the northeast section of the store near the loading dock (see Fig. 3-120).

Design drawings indicated that the Training Room/designated refuge area was 34 ft × 20 ft in plan, and bounded by the hard tilt-up east perimeter wall on the east side and three interior partition walls on the north, south, and west sides. The interior partition walls were made of steel stud frames (6 in. wide, 20-gauge, 16 in. on center), covered with 5/8 in. gypsum boards on one side and 1/2 in. plywood panels on the other. The hard wall that bounded the east side of this room comprised tilt-up wall panels that did not have positive connections to the concrete strip footing. North of this room was a group of wall panels (around the loading dock) that had some rotational capacity due to their positive wall-to-footing connection (designed for accidental truck collisions with the dock, see Fig. 3-46 in Sec. 3.2.1.3). The roof system was structurally similar throughout the store's interior. Thus, structurally speaking, the area along the same (east perimeter) wall and about two wall panels north of the Training Room (adjacent to the locker room near the loading dock, see Fig. 3-121) might have been a better selection for the best available refuge area in this store.

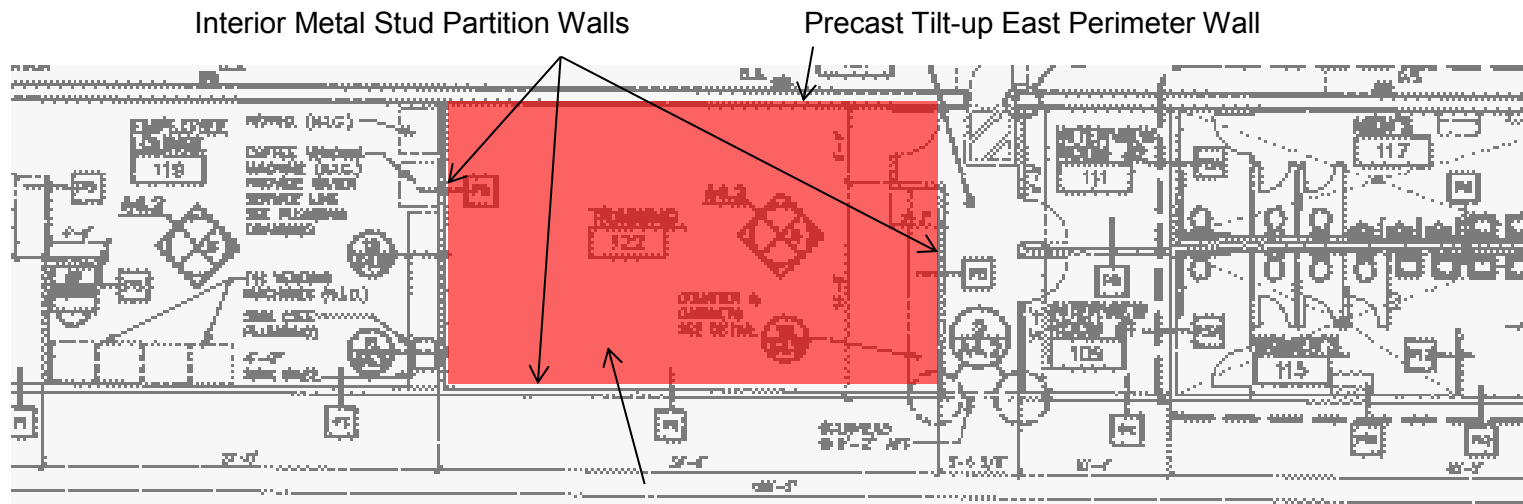

Training Room
(Designated Refuge)

© 2013 Homer TLC, Inc. Used with permission.

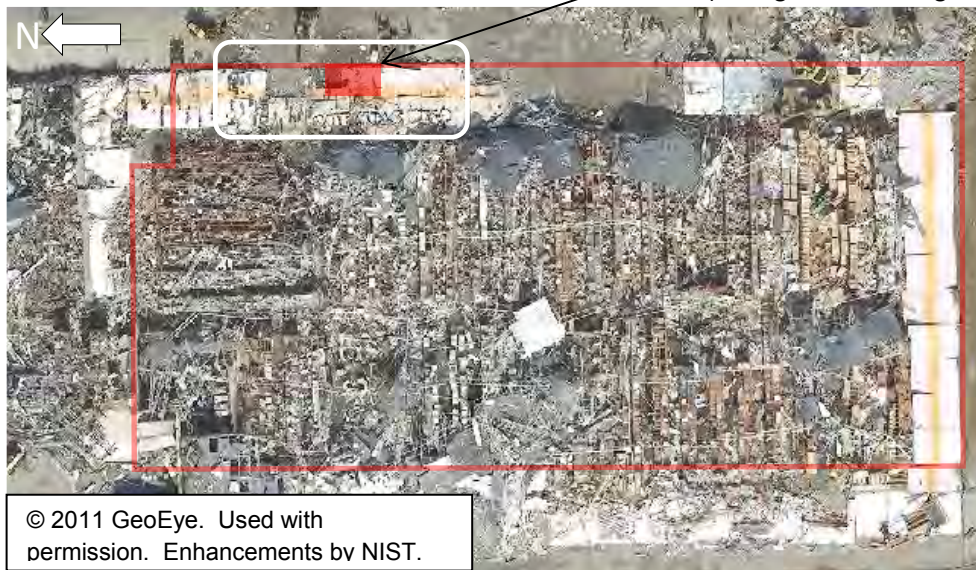

Figure 3–120. Location of the Training Room/designated refuge area at the Home Depot. Perimeter tilt-up wall panels here collapsed inward and onto the safe area.

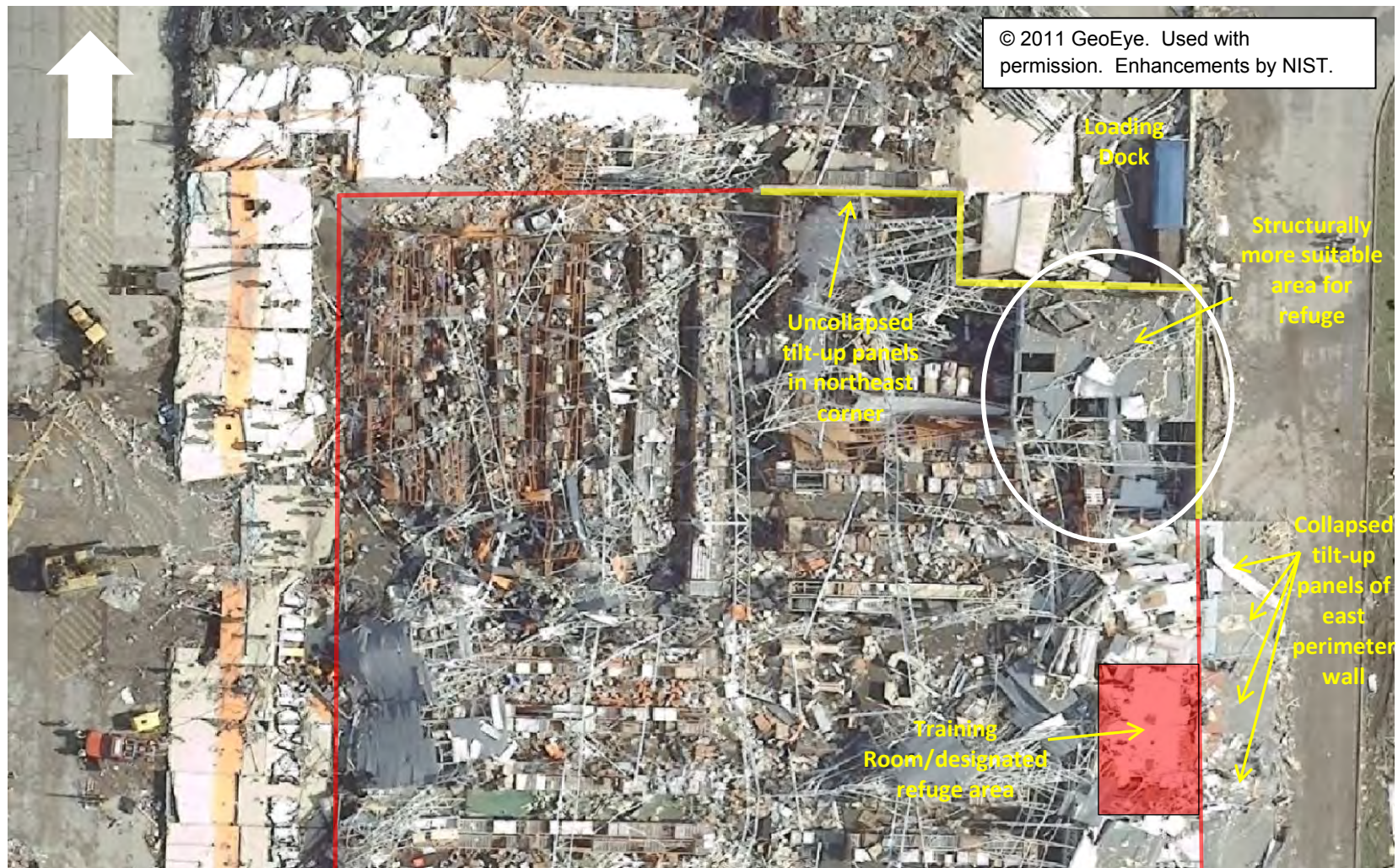

Figure 3–121. North section of the Home Depot. Red line indicates perimeter tilt-up wall panels that collapsed. Yellow line traces perimeter tilt-up wall panels (northeast corner, around loading dock) that did not collapse. Red rectangle designates the Training Room/designated refuge area.

As discussed in Sec. 3.2.1.3, the Home Depot sustained total collapse in the Joplin tornado, with 63 of its 73 tilt-up perimeter hard wall panels collapsing either inward toward the interior of the building or outward away from the interior of the building. The perimeter hard wall panels that bounded the designated refuge area were among the 63 that collapsed. However, they fortuitously collapsed outward away from the building and the refuge area in the Training Room (see Fig. 3–121 and 3–122), and thus averting the potential for further injuries or fatalities among the building occupants who might have sought shelter in this area.

In summary, the designated refuge area in the Home Depot did not provide better protection than other areas in the store during the May 22, 2011, Joplin tornado. An area near the loading dock may have been structurally more suitable to serve as a refuge, since the hard walls of this area had additional rotational capacity due to the design of the wall-to-footing connections. NIST does not have information on how the designated refuge area at this Home Depot was selected, including whether an experienced and qualified architect or engineer was consulted. Currently, such consultations are not mandatory and the selection can be done at the discretion of the facility owner. There were eight fatalities and an unknown number of injuries at the Home Depot. While media accounts indicated that there were injuries that occurred to occupants of the designated safe area, NIST was not able to obtain direct confirmation of the locations of the injuries and fatalities at this facility (see Chapter 4) including the designated refuge area.

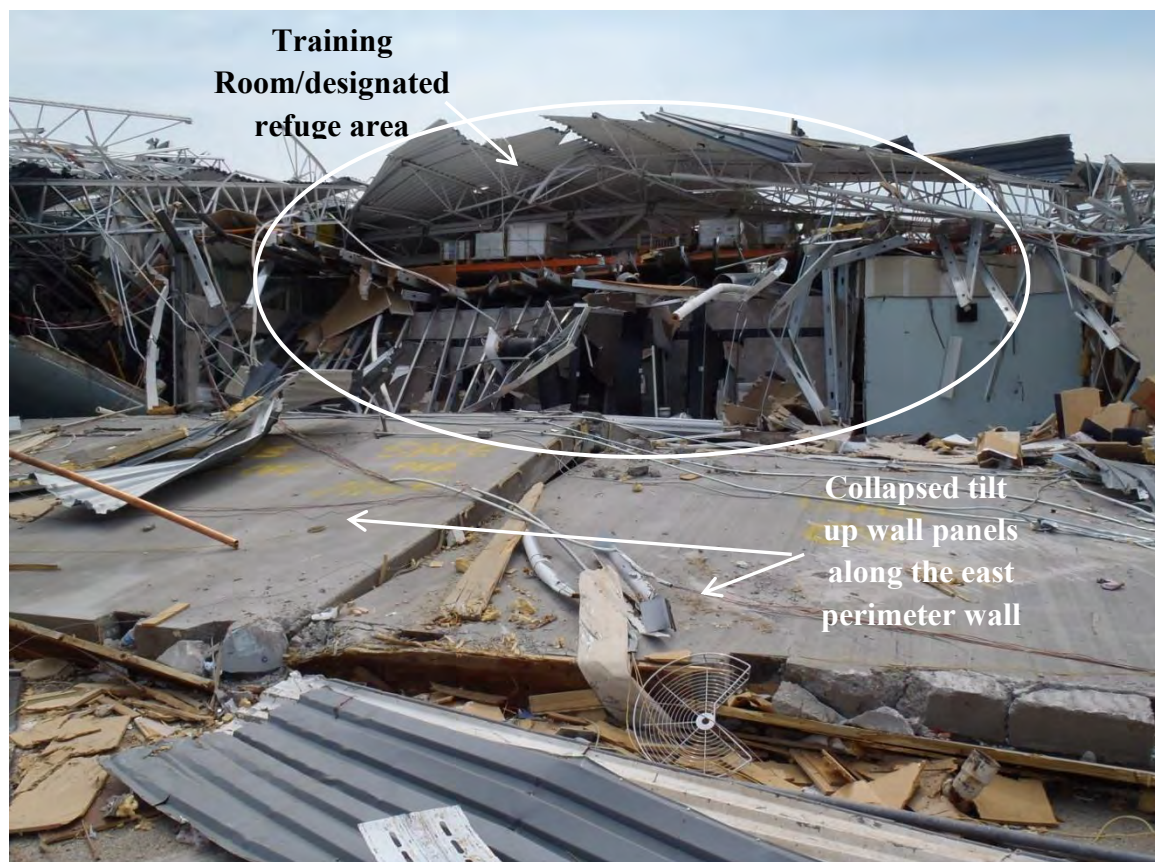

Figure 3–122. View, from outside toward the west, of the Training Room/designated refuge area of the Home Depot.

3.3.2 Schools

3.3.2.1 Designated Safe Areas at Joplin East Middle School

Joplin East Middle School had six designated refuge areas identified by door signs stating “Tornado Safe Shelter.” The refuge areas served different sections of the school. The school emergency evacuation plan had pre-planned evacuation routes directing occupants to these shelters specifically for tornado evacuation. Fig. 3–123 shows the locations of these designated refuge areas and associated evacuation routes.

As discussed in Sec. 3.2.1.4, Joplin East Middle School was the newest building complex among the engineered structures that were affected by the May 22, 2011, Joplin tornado, and two buildings toward the south half of the school, the Gymnasium and Auditorium, collapsed in the storm. NIST’s estimation of the wind environment using indirect methods (see Chapter 2) indicated that there was a sharp gradient between the wind speeds affecting the south and north halves of the school complex, with lower wind speeds affecting the north half (where most of the designated refuge areas were located). The collapsed structures were CMU and precast tilt-up BTS buildings with higher mean roof heights and longer span roof systems compared with other sections of the facility, which were made primarily of reinforced CMU walls with much shorter span roof systems (see facility description in Sec. 3.2.1.4). While the design drawings showed that the designated refuge areas were not specifically designed for tornado hazards, all six areas had design features known to typically survive tornadoes better than design features present in other areas of the school. These design features included being located toward the interior and away from windows, as well as having reinforced CMU hard wall protection and roof systems with short spans. The designated refuge areas were also located away from the Gymnasium and Auditorium, which were examples of a construction type that is known to have increased vulnerability to collapse in a tornado.

NIST does not have direct information on how these designated refuge areas were selected as “tornado safe shelters,” or whether a qualified engineer or architect was engaged in the process. However, given the school’s structural system and layout, and the collapses of two major buildings in the complex that did not affect any of the designated refuge areas, it is reasonable to conclude that these designated refuge areas were appropriately selected and represented the best available refuge areas at the school. There was only minor roof envelope damage (roof coverings) in these areas as a result of the Joplin tornado. This is likely due to the combination of their tornado-resistant design features (reinforced CMU walls with short span roof system) and the less intense wind speeds to which they were exposed. Fortunately the school was not occupied at the time of the tornado and there were no reports of fatalities or injuries at the school as a result of the Joplin tornado.

3.3.2.2 Designated Refuge Areas at Joplin High School

Locations of “storm shelters” (blue shaded areas) and pre-planned evacuation routes (red arrows) on the first floor of Joplin High School are shown on Fig. 3–124. Although NIST was able to obtain only a partial set of drawings for this facility, information from the available drawings and field damage surveys indicated that these designated areas were the best available refuge areas, though not hardened areas or shelters designed in accordance with the tornado design criteria identified earlier in this chapter. The

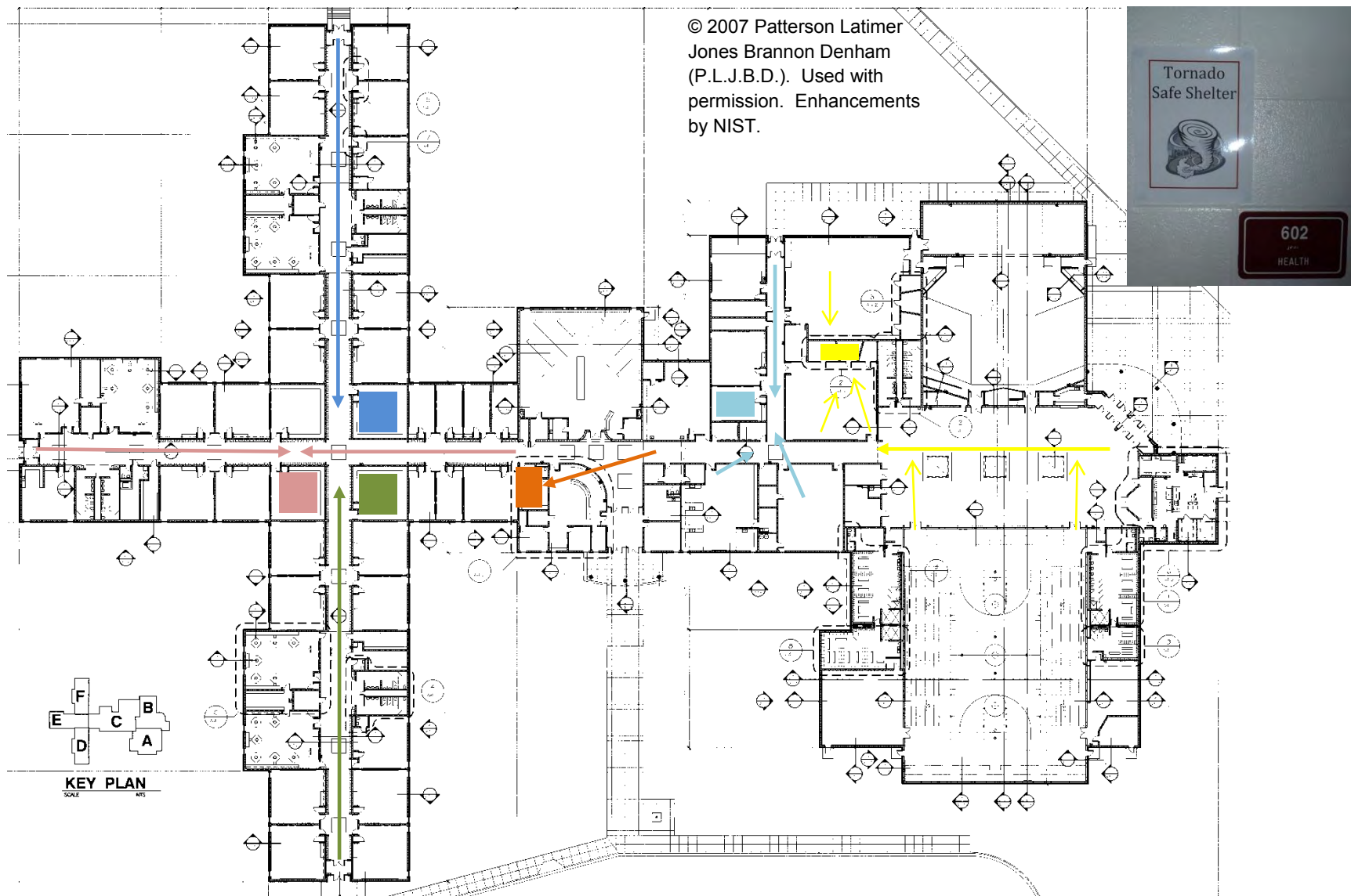
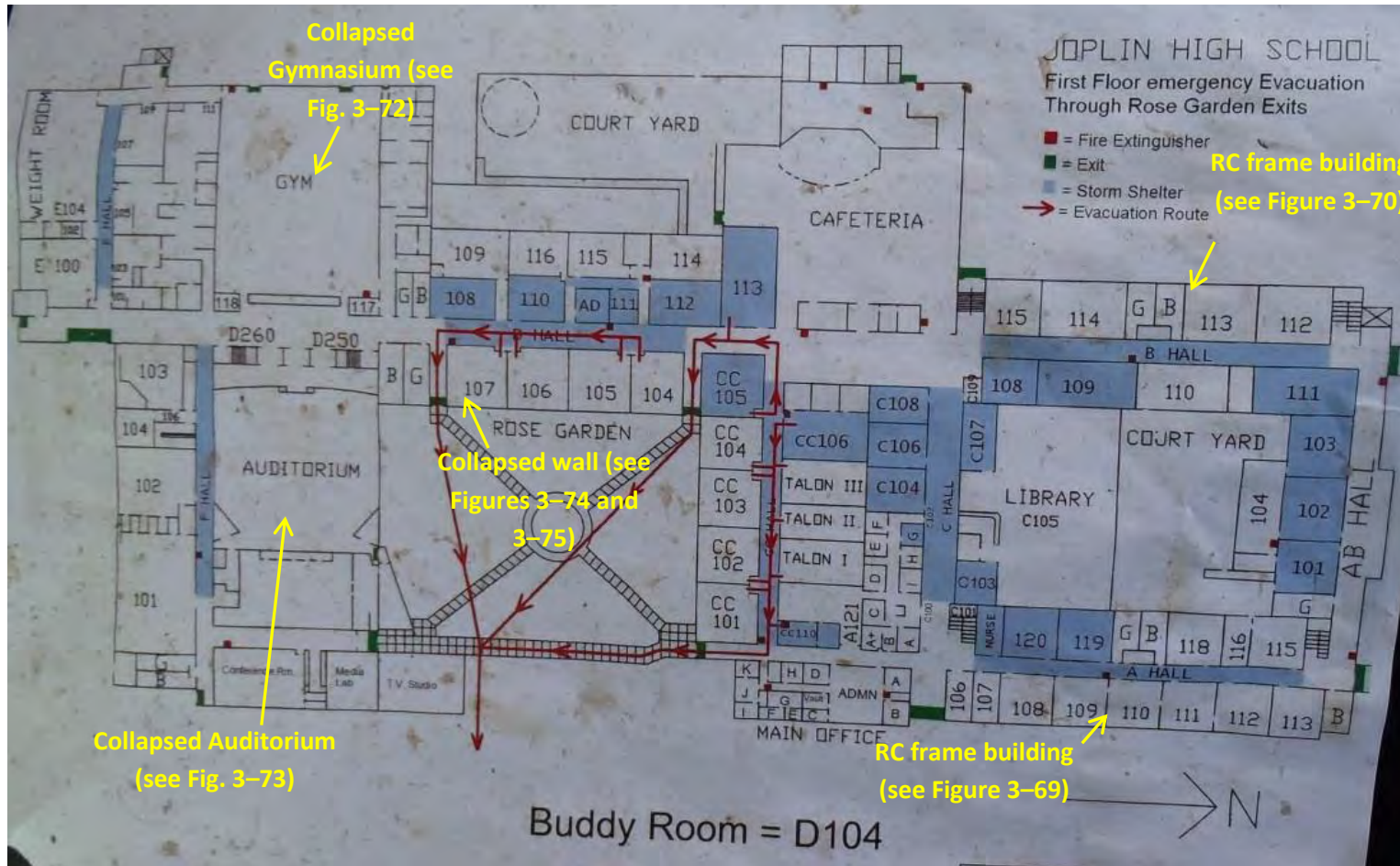

Figure 3–123. Locations of Tornado Safe Shelters (color blocks) in Joplin East Middle School and their associated, pre-planned tornado evacuation routes (arrows of corresponding color).



Source: FEMA MAT. Enhancement by NIST.

Figure 3-124. Locations of “storm shelters” at Joplin High School and pre-planned emergency evacuation routes.

”storm shelters” (blue shaded areas in Fig. 3–124) at Joplin High School were located throughout the school complex, and thus would be easily accessible to the school’s occupants. All were located toward the interior of their respective buildings. The largest number of designated refuge areas was concentrated in the two RC frame buildings (see description of these buildings in Sec. 3.2.1.5) in the north end of the school complex (A and B hallways, rooms 101 to 103, 108, 109, 111, 119, 120). These refuge areas are located on the interior, unexposed sides of the building, thus utilizing both the stronger structural system (RC frame MWFRS) and protective elements (shielding by RC floors and walls). Other designated refuge areas toward the middle and south end of the school complex, where the MWFRS was mostly BTS with CMU walls and steel roof diaphragms, were in the interior, away from windows, and in building sections with short roof spans.

While the high school sustained significant damage in the tornado (collapses of the BTS Gymnasium and Auditorium buildings at the south end of the school), and significant envelope damage on the wind–exposed sides of the RC frame buildings at the north end (see Fig. 3–66 and 3–67), none of the designated safe areas sustained any structural damage. The selection of these designated refuge areas appeared to have been well thought–out, and based on the aftermath of the May 22, 2011, Joplin tornado, these areas represented the best available refuge areas within the school complex. NIST does not have information regarding the selection process (whether qualified engineers or architects were engaged, etc.) or the school’s occupancy during the tornado. There were no reports of fatalities or injuries at this facility, and it was not known if anyone took shelter in any of the designated refuge areas during the storm.

3.3.3 High–Occupancy Health Care Facilities

NIST was able to obtain partial design information for the Ozark Center, including information on the locations of its designated refuge areas. NIST obtained information regarding emergency protocols used at SJRMC through interviews with survivors, and at the Greenbriar Nursing Home through interviews with survivors conducted by the CDC EPI–Aid study (see Chapter 4). This information, combined with data obtained from NIST’s field damage surveys, is reflected in the following discussion of the availability and effectiveness of refuge areas, if any, in these facilities.

3.3.3.1 Designated Refuge Areas at Ozark Center for Autism

As discussed in Sec. 3.2.2.1, the RC frame Ozark Center for Autism building sustained significant damage to its envelope and interior, but no structural damage to its MWFRS. Design drawings showed that the building had two designated “areas of refuge” located in the two stairwells of the building (see Fig. 3–125). These two areas were protected on all sides by reinforced CMU wall enclosures. Damage survey observations found that, while the building interior sustained significant damage as a result of wind and debris infiltration after the failure of the building envelope, the reinforced CMU stairwell enclosures were not damaged and thus would have continued providing protection for any refuge occupants.

NIST does not have information regarding occupancy of this building at the time of the May 22, 2011, Joplin tornado, including whether any occupants took shelter in the designated areas of refuge. Given the building design features and interior layout, as well as the significant damage that occurred to the building interior due to wind and debris infiltration (which highlighted the vulnerability of all interior areas of this

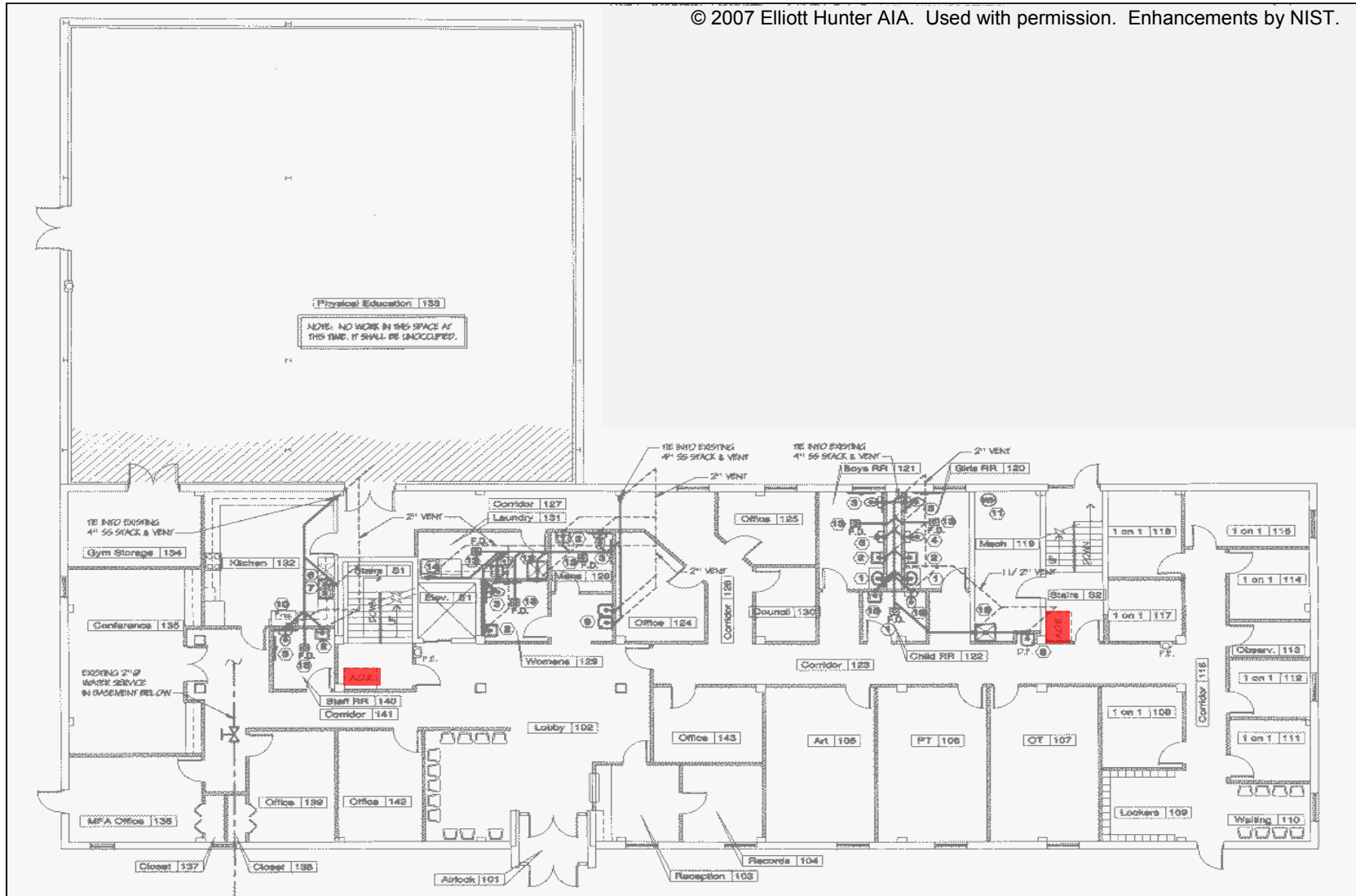

Figure 3–125. Locations of areas of refuge (AOR, red blocks) on the first floor of the Ozark Center for Autism building.

building to tornado hazards despite the building's strong MWFRS), the two designated "areas of refuge" appeared to have been appropriately selected. With the protection afforded by the reinforced CMU wall enclosures and their easy accessibility for building occupants, these areas represented the best available refuge areas compared with all other areas of this building.

3.3.3.2 Designated Refuge Areas at SJRMC

In case of emergency, the Condition Gray (see discussion in Chapter 4) emergency protocol in the East and West Towers of SJRMC, when executed, called for patients on each floor of the towers to be moved from their rooms (along the perimeter of each floor) into the hallway at the center of the floor. Thus, the hallway on each floor in SJRMC's East and West Towers was in effect used as a designated refuge area in the May 22, 2011, Joplin tornado. The use of these hallways, instead of more central, protective locations, was necessitated by the typically short tornado warning time and the complexity involved in quickly evacuating patients from multiple floors to such central locations.

As discussed in Sec. 3.2.1.1, the East and West Towers sustained minimal damage to their structural systems, but severe damage to their vertical envelopes (almost all dual-pane insulated glass windows were broken) and interior areas, including the hallways (designated refuge areas), due to wind pressure and wind-borne debris (see Fig. 3-126). According to interviews with survivors (see Sec. 4.4.8), occupants of the hallways were impacted by all sorts of wind-borne debris (medical equipment, x-rays, chairs, broken doors and glass, hailstones, insulation, etc.). Thus, while the hallways may be considered the best available refuge areas relative to other areas of each floor (except for the small areas in the three stairwells on each floor, which might be too small for the number of patients per floor and for more seriously ill patients) as they were furthest away from the windows of the patient rooms (see Fig. 3-127), they also were severely affected by the tornado hazards and did not provide adequate protection to occupants against wind and debris infiltration. The 14 fatalities that occurred at SJRMC included four ICU patients who were on respirators and believed not to have been moved into the hallways, one person located on the 3rd floor, and nine other occupants who were injured and subsequently died as a result of their injuries. Given the hazardous conditions caused by wind-borne debris described by occupants of the hallways (see Sec. 4.4.8), it is not unreasonable to conclude that there were injuries that occurred to occupants of the hallways/designated refuge areas in the SJRMC towers. However, NIST was not able to confirm the locations of the nine occupants who were injured and subsequently perished due to their injuries.

The damage at SJRMC ultimately led to the total demolition of the hospital and the construction of a new Mercy Hospital in Joplin at I-44 and Main Street, about 3 miles south of the old hospital site. According to the Sisters of Mercy,⁹⁰ the new facility, scheduled for completion in early 2015, will feature two underground levels and eight levels above ground. The lower floors will serve as shelter in place areas for the hospital. The above-ground floors will have safe zones with heavy-duty steel doors and other storm-resistant features such as laminated glass throughout the facility, hurricane-rated windows in critical areas, a concrete and brick exterior, two independent electrical feeds, two generators housed in a storm-resistant building (either generator can power the hospital independently) and windowless stairwells equipped with emergency lighting.

⁹⁰ www.mercy.net/sites/default/files/files/mercy-joplin-tornado-and-recovery-quick-facts-6324.pdf.



Figure 3–126. View of a typical hallway with damaged interior (ceiling, walls, and debris); hallways were used as designated refuge areas in SJRMC’s East and West Towers.

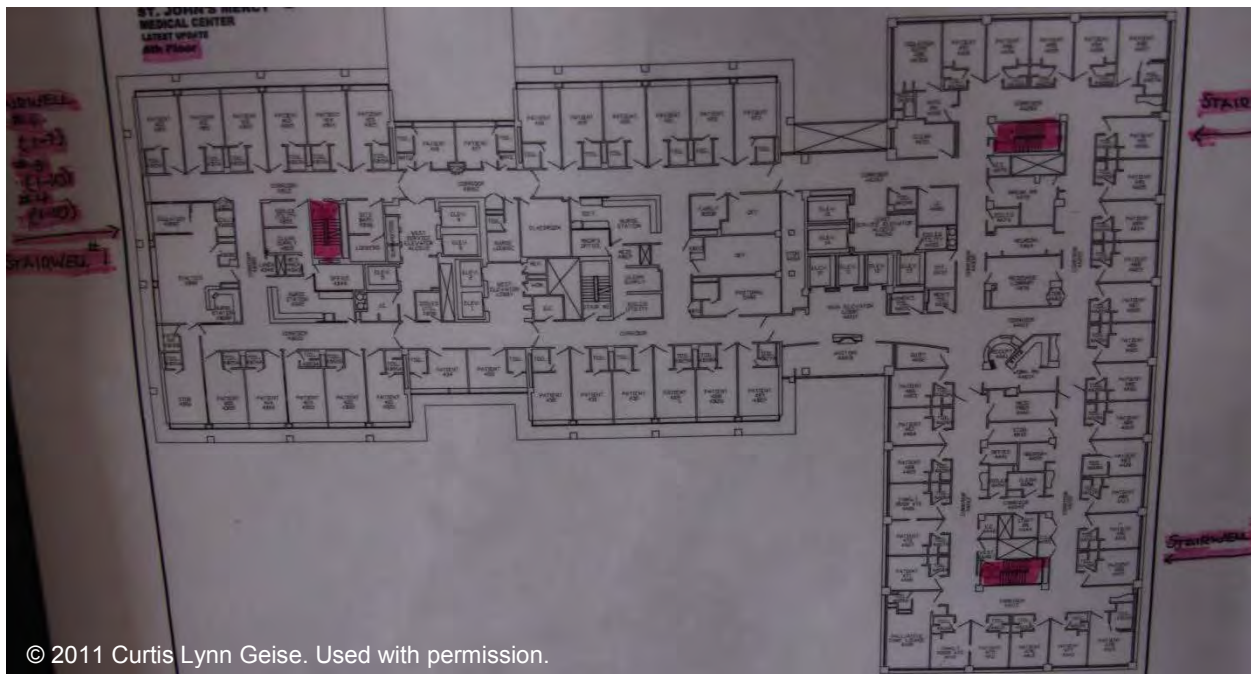

Figure 3–127. Typical floor plan of SJRMC’s East and West Towers (patient rooms along perimeter and hallway toward the center).

3.3.3.3 Designated Refuge Areas at the Greenbriar Nursing Home

NIST conducted a field damage survey of this facility after the May 22, 2011, Joplin tornado but was unable to obtain any design information or information regarding any areas within the building that were formally designated as refuge areas. The survey found that this unreinforced CMU building with a wood truss roof collapsed completely and there were no areas in its interior that were structurally hardened or protected with strong interior building elements and thus more suitable than other areas for use as refuges. Emergency procedures for tornadoes at this facility, described in Sec. 3.4.2, called for the staff to move residents to inner hallways and close all doors to residents' rooms to avoid flying glass. On May 22, 2011, the staff reportedly placed as many residents as possible in the central hallway (the hallway of the core section). Thus, according to these accounts, the central hallway of the core section, while there was no information confirming that it was formally designated as the refuge area, in effect was used as the designated refuge area (best available) at the Greenbriar Nursing Home on May 22, 2011.

This area, as all areas of this facility, sustained total collapse and people located there were exposed to impact by fallen construction materials as well as wind-borne debris. The total failure of this area illustrates that the effectiveness of the best available refuge area in a facility is constrained by the overall capacity of the host building. In buildings with structural systems that are more susceptible to collapse in tornadoes, the best available refuge area may not offer any real or increased protection. Occupants of older, high-occupancy facilities with residential types of construction (unreinforced CMU walls with wood roof systems) like the Greenbriar Nursing Home, were vulnerable during the May 22, 2011, Joplin tornado due to the lack of protection afforded by their in-facility refuge areas and the lack of access to any public shelters. As reported in Chapter 4, the Greenbriar Nursing Home sustained the highest number of fatalities, 19, for a single facility during the May 22, 2011, Joplin tornado.

3.3.4 In-Home Shelters

Like many other municipalities in tornado-prone areas, the City of Joplin does not mandate the construction of storm shelters or safe rooms in residential buildings (single-family homes or apartment buildings) or businesses. And at the time of the May 22, 2011, Joplin tornado, neither the City of Joplin nor Jasper County had or operated any public shelters or safe rooms.

While the potential life-saving benefits of in-home storm shelters/safe rooms in tornadoes are clear, and are demonstrated by the examples discussed later in this section, mandating them for residential construction, especially for multi-family apartments, would require careful consideration of other complex issues beyond the additional cost, including operational, accessibility, and liability issues. These complex legal and operational issues often militate against mandating the installation of storm shelters/safe rooms. As a result, municipalities in tornado-prone areas, despite knowing the risks and benefits, typically choose to encourage, rather than require, residential property owners to install storm shelters.

As indicated in Sec. 3.1, data from the Missouri Housing Development Commission showed that many of the areas affected by the May 22, 2011, Joplin tornado had high concentrations of rental properties, and thus a significant portion of the 20,820 people living in the affected area were likely renters (about 4,600

rental units were destroyed according to the Joplin Globe⁹¹). With the lack of public shelters in Joplin and with apartment buildings not required to provide shelters, this portion of the affected population would, in general, be expected to be more vulnerable to tornadoes as they depend for their protection on properties built and controlled by others. Often, the only options for shelter in multi-family buildings are the internal hallways of lower floors or the internal spaces, such as bathrooms or closets, within individual apartments.

In single-family homes, sheltering options beyond internal hallways, bathrooms, and closets may exist if an underground space (crawl space or basement) is available. The National Weather Service's pre-tornado warnings state that for people indoors "the safest place to be during a tornado is in a basement..." (see Sec. 4.6.2.2). In Joplin, due to geologic conditions, it is uncommon for residential structures to include basements (of the single-family homes that were affected in Joplin, only about 17 percent had either a full or partial basement according to the Pictometry[®] database). For residences in Joplin without space underground, one option has been to install an in-home storm shelter.

The design of in-home shelters (storm shelters and safe rooms) varies and encompasses both portable (pre-manufactured in factory and installed at job site) and custom-built (constructed at job site) shelters. Portable shelters are constructed in factory settings and are typically installed above-grade at the residence. Custom-built shelters are custom-built either as part of the design of new homes or as additions to existing homes and, if conditions allow, are likely to be located below ground (in a basement). The storm shelter industry is not regulated by the States or Federal Government and there are no mandated design criteria for in-home shelters in current building codes. Manufacturers and builders may follow voluntary guidelines provided by FEMA or ICC 500 in designing and constructing their shelters.

Two types of portable, in-home shelters were found in Joplin: steel shelters and Kevlar-reinforced shelters. Published information provided by manufacturers of these shelters indicated that they were designed based on criteria recommended in FEMA-320 and proof-tested against laboratory-simulated tornado hazards (wind speeds up to 250 mph and wind-borne debris impacts using 15 lb, 2 × 4 projectiles launched at 100 mph). Portable shelters are typically installed above-grade on concrete floors, often in garages, using anchor bolts (conventional steel bolts as well as epoxy anchors). The cost of installing a shelter of this type can vary with the size of the shelter (reportedly from around \$5,000 to \$15,000). For custom-built shelters, the primary construction material is typically reinforced concrete, and prescriptive guidance for the design and construction of custom-built shelters is also provided in FEMA publications. However, laboratory proof testing cannot be performed for custom-built shelters since they are not portable. Also, because there are no regulations governing the storm shelter industry, the design and construction of custom-built, in-home shelters can vary along with the qualifications and experience of their builders.

As in-home shelters were not mandated at the time of the May 22, 2011, Joplin tornado, there were no data on how many of the 7,411 damaged residential structures had in-home shelters. A factsheet⁹² issued by the manufacturer of Twister Safe[™] steel shelters indicated that there were 8 homes with Twister Safe storm shelters in the affected areas in Joplin on May 22, 2011. Several instances of in-home shelters

⁹¹ "Tornado poses questions about putting shelters in apartment buildings," Wally Kennedy, The Joplin Globe, Joplin, MO, August 6, 2011.

⁹² www.mssu.edu/news/2012/january/Twister-Safe-2012.php.

providing protection to residents have been reported since the tornado. In this section, two such instances, involving above-ground steel and Kevlar-reinforced shelters, are described. These shelters were in homes located west of SJRMC with different proximities to the center of the tornado damage path and different degrees of damage.

3.3.4.1 In-Home Steel Shelter

An above-ground portable steel shelter was installed in a home on South Adele Avenue, in close proximity to the estimated center of the tornado damage path and directly west of SJRMC. The wood-frame home and surrounding similarly constructed homes in this area sustained complete demolition (see Fig. 3-128). The home belonged to a family who had experienced a tornado and lost one family member as a result 3 years before in Racine, Missouri. This experience factored into the family's decision to install the portable steel shelter, which reportedly cost \$4,000, in the new family home on South Adele Avenue. As shown in Fig. 3-128, the wood-frame home was completely destroyed during the May 22, 2011, Joplin tornado, but the steel shelter was not damaged and remained anchored to the concrete garage floor. The homeowner and his daughter, who took shelter in this storm room, emerged unscathed.

3.3.4.2 In-Home Kevlar-Reinforced Shelter

An above-ground Kevlar-reinforced shelter was installed at a wood-frame home located on Alabama Avenue, west of SJRMC and in an area that sustained significant damage (see Fig. 3-129). The 4 ft × 4 ft shelter had Kevlar lining for its roof and walls, and was anchored onto the concrete garage floor using epoxy anchors. The home sustained significant damage, with the roof disconnected and lost and other damage to windows and the interior due to wind and debris infiltration. The shelter appeared completely intact, however, and the owner who took refuge in the shelter was unscathed (see Fig. 3-129 and 3-130).

3.3.5 Summary of Performance of Shelters/Designated Refuge Areas

The following are findings that pertain to the performance of shelters/designated safe areas during the May 22, 2011, Joplin tornado:

- The City of Joplin, like most other municipalities in tornado high hazard areas, and consistent with the adopted model building codes then in effect, did not mandate the construction of storm shelters/safe rooms in residential or commercial facilities at the time of the May 22, 2011, Joplin tornado.
- The lack of community storm shelters and of safe rooms in multi-family residential or commercial facilities meant that a large portion of Joplin population in the affected area who were living in multi-family residential buildings, or who were residents of nursing homes, did not have a protective option during the May 22, 2011, Joplin tornado.
- Individuals in Joplin had very few options for underground or tornado-resistant shelters. There were no community shelters or safe rooms in the City of Joplin or Jasper County at the time of the May 22, 2011, Joplin tornado. Also, 82 % of the homes in Joplin, MO were built without



Figure 3–128. Wood–frame home completely destroyed except for the steel shelter bolted to the concrete floor in the garage.



Figure 3–129. Above-ground Kevlar storm shelter bolted to concrete garage floor in residence that was damaged during the tornado.

Source: FEMA MAT.



Source: FEMA MAT.

Figure 3–130. Extent of damage (roof system disconnected) at residence with in-home, above-ground Kevlar storm shelter.

basements. Only a few non-residential buildings were equipped with underground locations (e.g., basements), and none identified with tornado-resistant above-ground shelters.

- While many of the facilities had designated refuge areas, several of these areas suffered severe damage. NIST found no evidence that these areas yielded positive outcomes with respect to loss of life. Most high-occupancy commercial and critical facilities surveyed by NIST in the tornado affected area (hospital, schools, and big-box stores) had in-facility designated refuge areas for tornados. However, the designation of these areas for refuge was not based solely on structural considerations. There are currently no design standards, requirements or best practice guidelines for designating refuge areas within existing commercial and critical buildings.
- Currently, there are optional model code provisions for design of specially purposed storm shelters and safe rooms, but such shelters are not required.
- Based on a few instances observed in this tornado, in-home shelters did perform well and provided life safety protection to the home owners. NIST found no data on how many of the approximately 7,411 damaged residential structures had in-home tornado shelters.

3.4 PERFORMANCE OF LIFELINES AS RELATED TO BUILDING FUNCTIONALITY

3.4.1 Overall Tornado Effect on Lifelines in Joplin

The tornado caused significant damage to electrical power, water, and gas utilities. The damage and service disruptions sustained by each of these lifelines are described in this section, using information from documents and interviews provided by the utility companies,^{93,94,95} from the Missouri Public Service Commission,⁹⁶ and from the City of Joplin.^{97,98}

3.4.1.1 Electricity

The May 22, 2011, Joplin tornado's effects on the electrical power system and infrastructure in the Joplin area caused approximately 20,000 Empire District Electric (EDE) customers to lose power during or immediately after the storm. Below is a summary of the overall damage to the local electrical power infrastructure:

- Transmission System
 - 10 high-voltage transmission lines out of service.

⁹³ <https://www.empiredistrict.com/newsroom/default.aspx>.

⁹⁴ *Missouri American Water Joplin Tornado Response* (<http://tristatewater.org/wp-content/uploads/2011/11/Matt-Barnhardt-Mo-American-Joplin-Tornado-Response.pdf>).

⁹⁵ <https://www.missourigasenergy.com/MGE/companyInfo/news.jsp>.

⁹⁶ The Joplin Experience: Utility and Regulator Lessons from the Past, Present, and the Future (<http://psc.mo.gov/CMSInternetData/PSCConnection/Publications/PSCConnection%2011-11.pdf>).

⁹⁷ www.joplintornadoanniversary.com/resources/city-of-joplin-factsheet5-14-12.pdf.

⁹⁸ www.joplintornadoanniversary.com/resources/community-press-kit.pdf.

- 135 transmission towers affected.
- Substations
 - Six power substations with step-down transformers initially impacted. Two of these (Substations 422 and 430) were damaged but repairable. One was completely destroyed (Substation 59, open steel frame, in close proximity to the estimated center of the tornado damage path, see Fig. 3–131).
 - Several transformers at the damaged substations sustained damage and leaked.
- Distribution System
 - Approximately 110 miles of aerial distribution line downed.
 - Approximately 4,000 distribution poles damaged.
 - 31 of 60 circuits damaged.
- Fiber
 - 30 fiber lines cut.

Following the tornado, and on an initial assessment of the damage, EDE focused first on de-energizing the downed power lines to ensure the safety of the public and emergency responders. Restoration of power was prioritized for critical facilities, i.e., hospital, other health care, human services, water, and communications facilities. Main feeders were restored to the Freeman Health System hospital (one of the two hospitals in Joplin, the other being SJRMC) well before dawn on the morning of May 23, 2011. Power was also restored to the Missouri American Water intake facilities before dawn on May 23, 2011 to the water treatment plant within 24 hours after the tornado, and to well facilities within 72 hours after the tornado. Power was provided to the temporary St. John’s Mercy Hospital location when it opened within 1 week of the storm. Schools were not included in the initial prioritization because the school year was already finished and schools were not being used as shelters.

EDE requested assistance from the Midwest Mutual Assistance Group on the afternoon of May 23, 2011. Whatever manpower, materials, and equipment were needed for restoration of power to critical facilities were given top priority, and remaining resources were used to begin work on other parts of the system. Repairs of transmission lines and work to repair or bypass the damaged substations were conducted simultaneously. The main thoroughfare in Joplin (along Range Line Road) was restored within 3 days. EDE worked to meet requests to restore power to businesses, while also reconnecting neighborhoods. Customers on the outer edges of the impacted area were switched to undamaged circuits that required no rewiring. In areas where there was some damage but the system was salvageable, repairs were made, and in areas where the system was heavily damaged or destroyed, it was rebuilt, typically from the outer edges in. Within the damaged area, electricity was not restored to buildings until after they were “green tagged” (i.e., determined to be safe for occupancy) by the city. In the most heavily damaged and destroyed areas, the system was completely redesigned and rebuilt, following a 2-month rebuilding moratorium issued by the city.

Heavily damaged residential neighborhoods having underground power distribution systems (e.g., west of Schifferdecker Avenue between 20th and 32nd Streets) took longer to restore than those with overhead systems. The underground service entrance pedestals were commonly damaged and buried under debris. EDE had to first verify that the power was out at each pedestal, then clear the debris and make repairs. There was often damage to the underground lines between the pedestal and the house, which was not always obvious. It was the responsibility of the home owner to have this damage repaired, which further delayed the power restoration.

A timeline for the restoration of power is provided in Table 3–7. Among the 20,000 customers who initially lost power, all customers able to receive power had it restored within 10 days to 12 days. Of the approximately 8,000 customers not initially able to return to the system, EDE reported that as of March 2013, 6,600 had returned. As of June 30, 2011, the total cost to rebuild the system, including substations, was estimated at \$25.7 million. By the one-year anniversary of the May 22, 2011 Joplin tornado (May 22, 2012), about 95 percent of the damaged primary power lines had been rebuilt. And on October 17, 2012, about 17 months after the May 22, 2011, Joplin tornado, the reconstruction of the destroyed Substation 59 was completed with its return to service.

3.4.1.2 **Water**

The tornado caused significant damage to the water system, which is described below using information from Missouri American Water Company (MAW) and the Missouri Public Service Commission:⁹⁹

- There were about 4,000 leaks in residential service lines and 25 torn fire-service lines. Even though MAW's transmission and distribution systems were underground, the multitude of above-ground leaks in service lines, primarily the result of uprooted trees and damage to homes and businesses (broken pipes), caused the pressure throughout the system to drop to well below the normal standard operating level and triggered the issuance of a water boil order by MAW and the Missouri Department of Natural Resources. The drop in water pressure and the damage to the fire-service lines could have reduced firefighting effectiveness in some areas of Joplin had it been needed.
- Two elevated water storage tanks lost pressure within 10 minutes, and were empty less than 2 hours after the May 22, 2011, Joplin tornado struck.
- An unreinforced brick storage building (built in 1898) that was part of MAW's water treatment plant collapsed. The plant was otherwise undamaged and remained operational on backup power.

Following the tornado, MAW first worked to shut down the entire system serving the affected area to stop the water pressure from continuing to drop. The company then conducted block by block walk-throughs of the impacted areas to shut down the 4,000 leaking service lines and 25 torn fire-service lines, while opening water mains to ensure that the impacted zone had fire protection.

⁹⁹ <https://www.empiredistrict.com/newsroom/default.aspx>.

Table 3–7. Timeline of electrical power restoration.

Date	Time	Reported Estimates of Number of customers without power	Comments
May 22	late afternoon		20,000 estimated total customers lost power
May 23	11am	18,000	
May 23	4pm	14,000	
May 23	9pm	13,700	
May 24	11am	17,000	Additional numbers due to additional customers reporting loss of service
May 24	4pm	16,000	FEMA estimated that 10,000 within storm path damaged area
May 24	9pm	14,000	
May 25	5pm	unavailable	EDE's Outage Management System (OMS) suffered a direct lightning strike earlier in the day
May 25	9pm	11,500	
May 26	5pm	11,000	
May 27	5pm	9,500	
May 28	5pm	8,000	
May 29	5pm	NR	EDE believed a significant number of the customers who are currently without service and can receive it will have electricity restored by tomorrow evening.
May 30	5pm	NR	EDE and visiting crews made continued progress today restoring service to several hundred facilities. Most large groups of customers have been returned to service and work to pick up small groups and individual customers is continuing.
May 31	5pm	NR	EDE reported it believes service has been restored to nearly all customers who are able to receive service. However, in light of the massive restoration effort, it is possible that a few customers may have been missed.

Key: NR, not reported.

Source: Empire District Electric press releases (<https://www.empiredistrict.com/newsroom/default.aspx>) and interview with EDE Director of Engineering and Line Services.

Within 24 hours after the May 22, 2011, Joplin tornado, water pressures had recovered in 60 percent of the Joplin system, although there was still a water boil order in place. Within 48 hours, pressures had returned to normal across the system except in the impacted area, and system flushing was begun. In the impacted area, all of the major leaks had been stopped within 4 days of the tornado, and fire service was then fully restored. The water boil order was lifted within 5½ days.

3.4.1.3 Natural Gas

The Missouri Public Service Commission¹⁰⁰ reported the following damage to Missouri Gas Energy's (MGE) infrastructure, which NIST confirmed in an interview with MGE:

- Approximately 3,500 gas meters were damaged or destroyed, and a multitude of gas leaks were caused by service-line pipes that were broken, when structures were destroyed.
- Roughly 55,000 ft of gas mains sustained damage.

Despite significant damage, service generally remained uninterrupted in undamaged areas. In responding to the emergency, MGE was able to shut off entire sections of the gas distribution system in some areas—shutting off individual gas leaks from damaged residences in the process. However, in areas with gas mains that also served critical facilities (like Freeman Health System hospital in Joplin) and needed to remain operational, MGE could not shut off the gas mains. Instead, it had to conduct street-by-street walking surveys of individual damaged structures ahead of the demolition and debris removal teams to shut off those service lines and risers serving structures that were damaged to the point of being uninhabitable. It took approximately 2 weeks for MGE to completely shut off all gas leaks. As of May 22, 2012, a year after the May 22, 2011, Joplin tornado, MGE had replaced roughly 70 percent of the damaged mains and restored approximately 20 percent of its service to those affected by the storm.

3.4.1.4 Communications

EDE reported that a total of 21 cell towers were nonfunctional following the May 22, 2011, Joplin tornado. The wireline network also experienced damage to aerial fiber-optic and copper cables. Voice communications in particular were severely degraded, although text messages were often able to get through. Mobile cellular towers were deployed by wireless carriers beginning less than 24 hours after the May 22, 2011, Joplin tornado. AT&T reported placing and splicing 18,000 ft of fiber and copper cables by May 27, 2011.¹⁰¹ Communications remained problematic for several days following the May 22, 2011, Joplin tornado.

¹⁰⁰The Joplin Experience: Utility and Regulator Lessons from the Past, Present, and the Future (<http://psc.mo.gov/CMSInternetData/PSConnection/Publications/PSConnection%2011-11.pdf>).

¹⁰¹<https://www.empiredistrict.com/newsroom/default.aspx>.

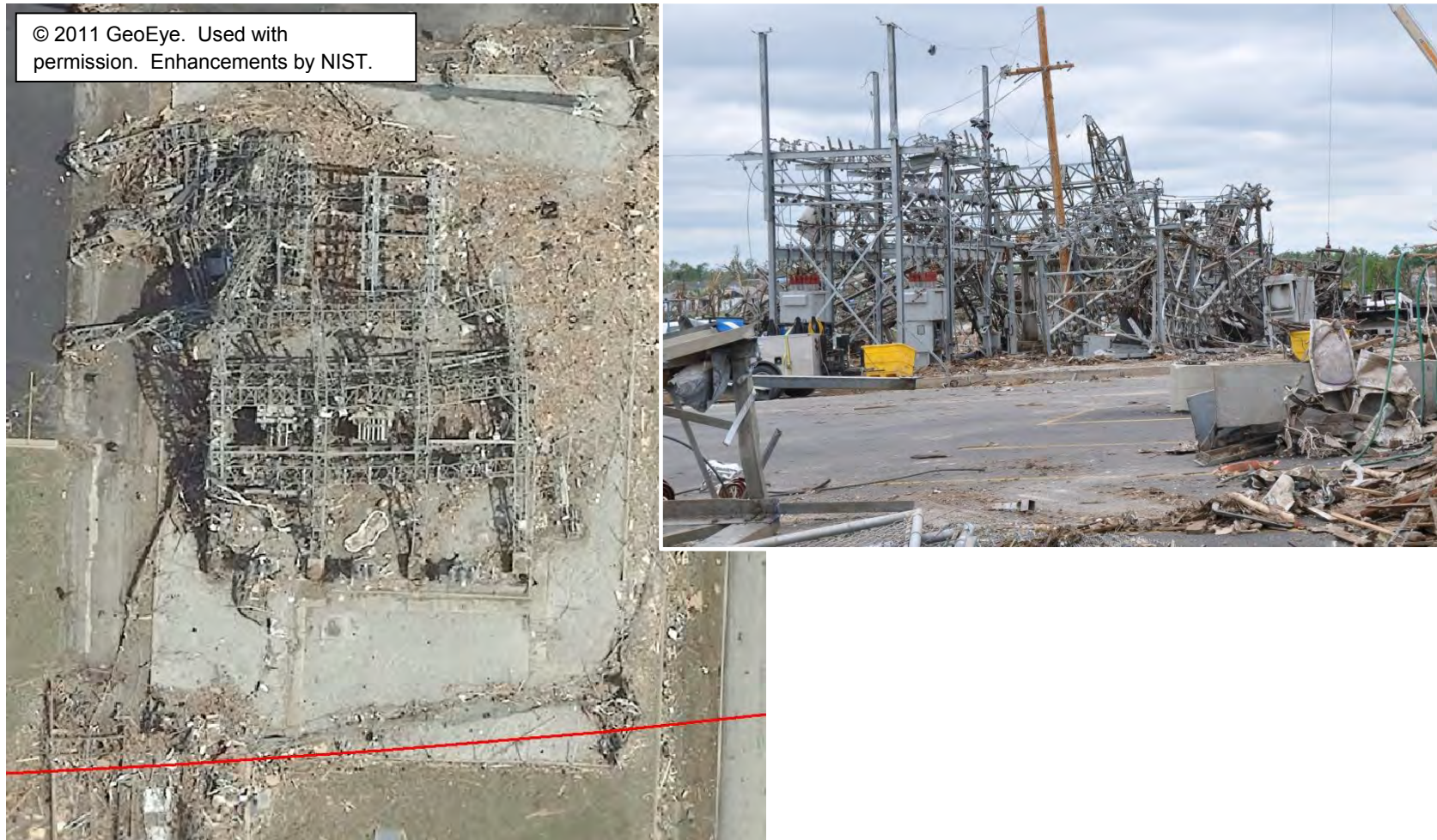

Figure 3–131. Destroyed EDE Power Substation 59.

3.4.2 Effect of Lifeline Disruptions on Building Operations

To examine the effect that the tornado-induced lifeline disruptions had on the ability of buildings to remain operational, it is instructive to compare the performance of the two hospitals in the region, SJRMC and Freeman Health System hospital in Joplin. Both facilities were affected, but to different degrees, by the May 22, 2011, Joplin tornado. SJRMC's buildings sustained significant damage to their envelopes and interiors (affecting windows, window mullions, roofs and roof coverings, curtain walls, partitions, ceilings, electrical fixtures and wiring, HVAC ductwork and equipment, and general building contents), with the generator building completely collapsed and the emergency power generator and power distribution system subsequently destroyed (see Sec. 3.2.1.1). Freeman Health System hospital in Joplin was outside of the damaged area and was only temporarily affected by the region-wide disruption of lifeline services, but otherwise was not impacted by the May 22, 2011, Joplin tornado. The extent of lifeline disruptions experienced at both facilities is summarized below:

- SJRMC:
 - Loss of main power supply due to overall damage to electrical transmission and distribution systems (downed feeder lines from Substation 59, damaged distribution poles and transmission towers, and the collapse of Substation 59 itself).
 - Loss of emergency backup power due to the collapse of the generator building and associated damage to, and complete loss of, the emergency power generator and power distribution system.
 - Damaged interior electrical distribution system due to failure of buildings' envelopes and subsequent wind and debris infiltration.
 - High-pressure natural gas leak due to damage to the reducer gas pipe on the west wall of the Chiller Plant building (see Fig. 3–132).
 - Damaged and leaking liquid oxygen tank on the west side of SJRMC (see Fig. 3–133).
 - Damaged water and gas service lines.
 - Damaged interior water and sprinkler systems.
- Freeman Health System hospital in Joplin:
 - Loss of main power supply due to downed main and backup feeder lines to the facility. The facility continued to operate using backup power until the main power supply was restored. As the hospital was not structurally affected, all lifeline distribution systems within the facility remained intact and functional.

In terms of continuity of operations, the difference between SJRMC and Freeman Health System could not be more drastic. SJRMC immediately set up a triage area and, within a week, a 60-bed temporary field hospital in the parking lot of the existing hospital complex, but was never able to return its damaged facilities to any levels of operation, and ultimately decided to abandon the damaged facility and rebuild at



Figure 3–132. High–pressure gas reducer valve at SJRMC that was damaged and leaked.



Figure 3–133. Liquid oxygen tank at SJRMC that leaked.

another location. In contrast, by May 23, 2011, a day after the tornado, Freeman Health System in Joplin was connected to an alternate electrical feeder line and full power supply and the hospital's full functionality was restored. The complete loss of building functionality at SJRMC meant that Freeman Health System and other regional hospitals had to accommodate a sudden increase in the demand for their services from people affected by the tornado. Operating on its backup power supply, Freeman was able to provide care for more than 500 wounded survivors in the first hours after the storm, including 22 life-saving surgeries in the first 12 hours, and eventually, with its main power supply restored, served more than 1,700 victims of the May 22, 2011, Joplin tornado in the days that followed the event.

The different outcomes between the two hospitals illustrated that, despite the damage sustained by lifeline systems and the complexity involved in restoring services due to debris- and safety-related issues, regional utilities were able to cope and provide services to those critical facilities that were still able to receive them. In other words, the disruption of lifeline services available to SJRMC was not the main reason for the facility's loss of functionality. Rather, it was the devastation to its buildings' interiors caused by the failure of building envelopes that was the primary reason for the complete loss of functionality. Even if SJRMC's emergency backup power supply had not been disrupted, the facility would still not have been able to receive restored lifeline services (as did Freeman Health System hospital within 1 day) due to the widespread interior damage that destroyed SJRMC's internal lifeline distribution systems. Thus, while backup power is important for enabling the uninterrupted operation of critical facilities, as was demonstrated by Freeman Health System hospital, better protection of building envelopes is also important for enabling backup and restored lifeline services to be utilized, as well as for better protecting building occupants.

In terms of structural capacity, critical facilities with a robust MWFRS and lateral load system that does not rely on the roof diaphragm for stability, like concrete and steel moment frames, demonstrated their ability to resist intense tornado hazards (wind speeds well in excess of the design wind speed, plus impacts by all manner of wind-borne debris) without structural collapse in the May 22, 2011, Joplin tornado. However, with regard to the lifeline services required for continued operation of such facilities, the May 22, 2011, Joplin tornado highlighted that these services comprise two separate segments. One segment is external to the facilities, controlled by lifeline service providers, and consists of regional transmission and distribution systems. Regional utilities demonstrated in the Joplin tornado that lifeline services can be quickly and safely restored to critical facilities (including health care providers, fire stations, and water supply and treatment facilities) despite the severity of the damage and the complexity of restoration.

The other segment of lifeline services is internal to the facilities, and consists of the backup and distribution systems controlled by the facilities. It is this second segment of lifeline systems that, if not well protected, can cause prolonged disruptions to facility operations by rendering the facility unable to receive restored services from utility providers. This segment, to remain functional, requires that building envelopes remain intact. Protected envelopes are also needed to maintain vertical movement (elevators) in multistory buildings. Thus, the most important issue that must be addressed to maintain the functionality of critical facilities in tornadoes may be requirements for improved performance/protection of building envelopes. Losing the envelope also means that, even if utilities are restored after a tornado, the building would remain non-functional due to the inability to meet operational requirements of the building codes for maintaining temperature control. Improved performance of the building envelope, in the case of SJRMC, would have required impact-resistant window glazing and more robust curtain walls

like those rated for hurricane-prone regions. While this would add cost to the construction of critical facilities, this added cost must be weighed against the potential costs associated with the disruption of services that are vital to a community, as well as the costs associated with proper clean up, demolition, and rebuilding.

3.4.3 Summary of Performance of Lifelines

The following findings are related to performance of lifelines that pertain to the operation of buildings during the May 22, 2011, Joplin tornado:

- All utilities (water, gas, power) were lost in the areas damaged by the May 22, 2011, Joplin tornado. While the utilities restored service to critical buildings (e.g., Hospitals, water treatment plant) within 24 hours, the damage sustained within these buildings did not allow them to utilize the power, water and gas service.
- Despite the devastation sustained by lifeline systems and the complexity involved in restoring services due to debris- and safety-related issues, regional utilities were able to cope and restore services to those critical facilities that were still able to receive them.
- Failure of the building envelope of the NIST-surveyed critical facilities, leading to damage to internal lifeline distribution systems, was the primary cause of their complete loss of building functionality. Losing the envelope also meant that, even if utilities had been restored after the May 22, 2011, Joplin tornado, the building remained non-functional, due to the inability to meet building code requirements for maintaining temperature control.
- The design wind speed for critical buildings built prior to 1998 was higher than that used for buildings that housed the backup generators for those critical buildings.

3.5 REFERENCES

- ACI (American Concrete Institute). 1996. *Building Code Requirements for Masonry Structures*. ACI 530/ASCE 5/TMS 402. November.
- ACI (American Concrete Institute) Committee 551. 1997. *Tilt-Up Concrete Structures*. Reported by ACI Committee 551. ACI 551 R-92. Reapproved 1997. American Concrete Institute. Farmington Hills, MI.
- ACI (American Concrete Institute) Committee 551. 2003. *Tilt-Up Concrete Structures*. Reported by ACI Committee 551. ACI 551 R-92. Reapproved 2003. American Concrete Institute. Farmington Hills, MI.
- ANSI/ANS (American National Standards Institute/American Nuclear Society). 1983. *Standard for Estimating Tornado and Extreme Wind Characteristics at Nuclear Power Sites*. ANSI/ANS-2.3-1983. American Nuclear Society. La Grange Park, IL.
- ANSI/ANS (American National Standards Institute/American Nuclear Society). 2011. *Estimating Tornado, Hurricane, and Extreme Straight Line Wind Characteristics at Nuclear Facility Sites*. ANSI/ANS-2.3-2011. American Nuclear Society. La Grange Park, IL.
- ASCE (American Society of Civil Engineers). 1995. *Minimum Design Loads for Buildings and Other Structures*. ASCE 7-95. New York, NY.
- ASCE (American Society of Civil Engineers). 1998. *Minimum Design Loads for Buildings and Other Structures*. ASCE 7-98. New York, NY.
- ASCE/SEI (American Society of Civil Engineers/Structural Engineering Institute). 2010. *Minimum Design Loads for Buildings and Other Structures*. ASCE/SEI 7-10. Reston, VA.
- Boissonnade, A. 2000. *Development of a Probabilistic Tornado Wind Hazard Model for the Continental United States*. Vol. 1. Lawrence Livermore National Laboratory. Prepared for the U.S. Department of Energy. Washington, DC.
- City of Joplin. 1992. Council Bill 92-218, Ordinance 93-6 Amendments to the BOCA National Building Code.
- City of Joplin. 2011. Council Bill 2011-024, Ordinance Amendments to the International Residential Code. Ordinance No. 2011-142 (August 2011).
- City of Joplin Code of Ordinances*. 2008. Part II-Code of Ordinances, Chapter 26-Buildings and Building Regulations, Article XIV-Registration Statement. Ordinance No. 2008-068 (May 2008).
- DOE (U.S. Department of Energy). 2002. *Natural Phenomena Hazards Design and Evaluation Criteria for Department of Energy Facilities*. DOE-STD-1020-2002. Washington, DC, January.

- FEMA (Federal Emergency Management Agency). 2007a. *Design Guide for Improving Critical Facility Safety from Flooding and High Winds*. Risk Management Series. FEMA 543. Washington, DC, January.
- FEMA (Federal Emergency Management Agency). 2007b. *Design Guide for Improving Hospital Safety in Earthquakes, Floods, and High Winds*. Risk Management Series. FEMA 577. Washington, DC, June.
- FEMA (Federal Emergency Management Agency). 2008a. *Taking Shelter from the Storm: Building a Safe Room for Your Home or Small Business*. FEMA P-320, Third Edition. Washington, DC, August.
- FEMA (Federal Emergency Management Agency). 2008b. *Design and Construction Guidance for Community Safe Rooms*. FEMA P-361, Second Edition. Washington, DC, August.
- FEMA (Federal Emergency Management Agency). 2009. *Tornado Protection: Selecting Refuge Areas in Buildings*. FEMA P-431, Second Edition. Washington, DC, October.
- FEMA (Federal Emergency Management Agency). 2010. *Design Guide for Improving School Safety in Earthquakes, Floods, and High Winds*. Risk Management Series. FEMA P-424. Washington, DC, December.
- FEMA (Federal Emergency Management Agency). 2012. *Spring 2011 Tornadoes: April 25–28 and May 22, Building Performance Observations, Recommendations, and Technical Guidance*. Mitigation Assessment Team Report. FEMA P-908. Washington, DC, May.
- FM Global. 2011. Hazard Assessment Mercy St. John's Regional Medical Center Joplin, Missouri. St. Louis, MO, June.
- Fujita, T. T. 1971. *Proposed Characterization of Tornadoes and Hurricanes by Area and Intensity*. SMRP Research Paper No. 91. University of Illinois. Champaign-Urbana, IL.
- ICBO (International Conference of Building Officials). 1988. *Uniform Building Code*. UBC-1988.
- ICC (International Code Council). 2012a. *International Building Code*. Falls Church, VA.
- ICC (International Code Council). 2012b. *International Residential Code for One- and Two-Family Dwellings*. Falls Church, VA.
- ICC/NSSA (International Code Council/National Storm Shelter Association). 2008. *ICC/NSSA Standard for the Design and Construction of Storm Shelters*. ICC 500-2008, American National Standard. Washington, DC, June.
- LaRue, J. 2011. Joplin Missouri Tornado Damage Assessment, St. John's Regional Medical Center. HKS Inc. June 21.
- NFPA (National Fire Protection Association). 2012. *Building Construction and Safety Code*. NFPA 5000. Quincy, MA.

- NIST (National Institute of Standards and Technology), 2013. *Preliminary Reconnaissance of the May 20, 2013, Newcastle-Moore Tornado in Oklahoma*. NIST Special Publication 1164. Gaithersburg, MD, November.
- NIST (National Institute of Standards and Technology). 2006. *Performance of Physical Structures in Hurricane Katrina and Hurricane Rita: A Reconnaissance Report*. NIST Technical Note 1476. Gaithersburg, MD, June.
- NRC (U.S. Nuclear Regulatory Commission). 1974. *Design Basis Tornado and Tornado Missiles for Nuclear Power Plants*. NRC Regulatory Guide (NRC/RG) 1.76. Washington, DC.
- NRC (U.S. Nuclear Regulatory Commission). 2007. *Design Basis Tornado and Tornado Missiles for Nuclear Power Plants*. NRC Regulatory Guide (NRC/RG) 1.76. Washington, DC.
- PCA (Portland Cement Association). 1987. *Connections for Tilt-Up Wall Construction*.
- PCI (Precast/Prestressed Concrete Institute) Concrete Handbook Committee. 1999. *PCI Design Handbook: Precast and Prestressed Concrete*. Fifth Edition. Precast/Prestressed Concrete Institute. Chicago, IL, April.
- Ramsdell, J. V., J. P. Rishel. 2007. *Tornado Climatology of the Contiguous United States*. NUREG/CR-4461, Rev. 2. Pacific Northwest National Laboratory. Prepared for the U.S. Nuclear Regulatory Commission. Washington, DC, February.
- SEAKM (Structural Engineers Association of Kansas and Missouri). 2012. *Investigations and Recommendations based on the May 22, 2011 Joplin, Missouri Tornado*. May. Available at www.seakm.com/.
- SSE, Inc. 2011. *Emergency Rapid Structural Condition Assessment—St. John’s Regional Medical Center, 2727 McClelland Boulevard, Joplin, MO 64804-1694 and Associated Facilities*. SSE Project No. 2011054. St. Louis, MO, June 3.
- TCA (Tilt-Up Concrete Association) Natural Disaster Task Force. 2012. *Analysis of Damage from Historic Tornado in Joplin, Missouri, U.S.A. on May 22, 2011: A Report to the Technical Committee of the Tilt-Up Concrete Association*. Report 201-12-01. Tilt-Up Concrete Association. Mount Vernon, IA, January 12.
- Wind Science and Engineering Center. 2006. *A Recommendation for an Enhanced Fujita Scale (EF-Scale)*. Texas Tech University. Lubbock, TX.

Chapter 4

EMERGENCY COMMUNICATIONS, PUBLIC RESPONSE, AND TORNADO DEATHS AND INJURIES

The Missouri State Police Department attributed 161 deaths¹⁰² and the City of Joplin attributed more than 1,000 injuries¹⁰³ to the tornado that struck Joplin, Missouri, on May 22, 2011. With the tornado hazard and the performance of buildings already described, the question remains as to why this tornado produced the largest death toll for a single tornado since record keeping began in 1950. The objective of Chapter 4 is to describe the pattern, locations, and causes of the fatalities and injuries attributed to this tornado, and to examine the associated emergency communications and public response. This chapter provides an understanding of the reported behavior of individuals exposed to the effects of the May 22, 2011, Joplin tornado, and of the factors that influenced survival or death. Survivability is analyzed in the context of protective action behavior (whether, and where, people took shelter), the performance of the buildings used as shelters, and the environmental conditions to which people were exposed. The purpose of this portion of the investigation is to identify recommendations relating to emergency communication, building and shelter performance, and public training or education that can improve public safety in future tornadoes.

This chapter will cover a number of topics related to emergency communications, public response, and the resulting tornado casualties. These topics include the following: (1) the historical research record on public warning response in disasters, (2) an overview of the data collected to investigate the behavior and fate of individuals affected by this tornado, (3) a discussion of the conditions of Joplin, MO before the tornado hit, including emergency communications, emergency procedures for tornadoes, and previous tornado history, (4) a timeline of the tornado that struck Joplin on May 22, 2011 and the public's response to the tornado, (5) a discussion of the casualties that resulted from the tornado, and (6) the identification of factors that likely caused the impact-related deaths and severe injuries that resulted from the May 22, 2011, Joplin tornado—both outside and inside of structures.

4.1 PUBLIC WARNING RESPONSE IN DISASTERS

The purpose of this section is to summarize what is known about public response to alerts and warnings for imminent disasters based on the historical research record. Before research is presented, the difference between an alert and a warning should be made clear. An alert is used to gain people's attention and is often provided separately from the warning message. A warning message is meant to provide information to the public on the state of the emergency and what they are supposed to do in response to this emergency.

¹⁰² A list of the deceased was sent to NIST on June 20, 2011, which included the name, date of birth, and home address of each decedent, as well as where the death occurred, the type of injuries that led to the fatality, and the name of the associated funeral home.

¹⁰³ *Community Press Kit* issued for the Day of Unity observance, May 22, 2012, <http://www.joplintornadoanniversary.com/resources/community-press-kit.pdf>.

Research has shown that the response of an individual during an emergency can be characterized as a decision-making process in which people receive information from their environment, interpret that information, and respond based upon their interpretations (Lindell and Perry 2004). The process of decision-making begins when people are first presented with cues from their environment. In a tornado, specifically, these cues can consist of a siren, radio or television broadcasts, calls from loved ones, or even the presence of the tornado bearing down upon them. The introduction of these cues initiates a series of processes that must occur in order for the individual to respond. A simplified version of this process is presented here:

1. Perception: the individual must perceive or receive the cue(s); e.g., a visual signal must be seen or an audible signal or warning must be heard
2. Attention: the individual must pay attention to or take note of the cue(s)
3. Comprehension: the individual must comprehend the cue(s) and/or information that is being conveyed
4. Threat identification/Believing: the individual must believe that the incident suggested by the cues and/or information is a credible threat
5. Threat perception/Personalizing: the individual must personalize the threat (i.e., feel that the incident is a threat to him/her) and feel that protective action is required; i.e., something needs to be done.

Once the individual engages in each stage of the process and in turn, personalizes the risk, the individual engages in a decision-making process to identify 1) what can be done to achieve protection, and 2) the best available method for achieving protection.

The historical research record supports the provision of information (i.e., providing a warning message rather than simply an alert) as a method to enhance public protective action response. When issuing emergency messages, there are five key aspects of a successful warning message. These five aspects are presented here, with associated references:

- *The message delivered by a credible source* (Drabek and Boggs 1968; Mileti and Beck 1975; Mileti and Darlington 1995; Sellnow et al. 2012; Vihalemm, Kiisel and Harro-Loit 2012; Stephens, Barrett and Mahometa 2013);
- *Guidance or telling people what to do to protect themselves* (Sorensen 1991; Mayhorn and McLaughlin 2012);
- *The hazard or explaining why they should act* (Mallett, Vaught and Brnich 1993; Neuwirth, Dunwood and Griffin 2000; Sellnow et al. 2012);
- *The location, i.e., informing the public about who should act in terms of the physical location at risk* (Mileti and Fitzpatrick 1991) and,
- *Time or telling the public by when they should have completed taking the protective action* (Sorensen, Shumpert and Vogt 2004).

Similarly, there are five key factors, unrelated to alerts and warnings, that can enhance public protective action response in disasters. The five key factors are listed here, with associated references:

- *The presence of social and/or physical cues.* Physical cues are cues from the physical environment that an individual can hear, feel, see, smell or taste (if applicable), and social cues

are those that come from other people whom the individual communicates with or observes [Kuligowski and Mileti 2009; Mileti and O'Brien 1993];

- *Statuses* (e.g., the individual's income, education, occupation, age, race, gender, ethnicity, and country of origin). In other words, people with certain types of statuses, for example, older individuals rather than younger individuals [Proulx and Pineau 1996], are more likely to take protective actions in a disaster [Fothergill 1998; Fahy and Proulx 1997];
- *Roles or the social position held within a personal or professional environment* (e.g., mother, manager, fire fighter, etc.). Similarly, people with certain roles, for example, managers [e.g., Kuligowski 2013], are more likely to take protective actions in a disaster;
- *Having experience with and/or knowledge/training on response to disasters or situations similar to emergency conditions* [Gershon et al. 2007; Perry and Lindell 1986]; and
- *Having pre-event risk perceptions* (i.e., believing in a higher likelihood of a disaster occurring in the future) [Lindell and Perry 2004; Slovic et al. 2004].

The findings specific to tornado research replicate the historical research record of public response to alerts and warnings across many different hazards types. For example, tornado research has shown that understanding the situation and what to do about it (Liu et al. 1996; Alberta Public Safety Services 1991) increases an individual's personalization, or perception, of risk (i.e., stage five in the decision-making model). Also, tornado research has identified factors, unrelated to alerts and warnings, shown to increase an individual's perception of risk, and in turn, the likelihood of his/her response. These are listed here, categorized by the factors discussed above:

- *Physical and social cues:*
 - Receiving multiple, consistent cues that lead to the conclusion that a tornado is a threat (NWS 2009; Hammer and Schmidlin 2002);
 - Achieving visual confirmation of the storm (NWS 1993a; NWS 1993b);
 - Seeing others taking protective actions (NWS 2009);
 - Receiving face-to-face or informal warnings (i.e., from family and friends) (NWS 2009; Colorado Department of Public Safety 1991);
- *Having experience:* Personal experience with hazards and disasters (Hodler 1982), including experience that is perceived as negative in nature (Kuligowski 2011).

4.2 DATA COLLECTION

The tornado damaged an area within the City of Joplin having an estimated population of 20,820 (U.S. Census Bureau 2011). In order to investigate the behavior and fate of individuals affected by this tornado—both those who survived and those who did not—three sets of information were collected. First, data were collected on the response of the public before the tornado hit. Here, it was of interest to understand how individuals (both those who survived and those who did not) became aware that a tornado was imminent and the ways in which they responded to this awareness. Second, information was collected on the consequences of the tornado for the people exposed, i.e., the casualties (both injuries and fatalities) resulting from the event. These data included, but were not limited to, the locations where people were injured (or killed), the causes of the casualties (if known), and the nature of people's injuries (some of which led to death). Finally, data were collected from emergency response personnel to learn about the pre-tornado emergency plans of the City of Joplin and Jasper County and how these plans were implemented on May 22, 2011. These data allow for observations to be made on whether the tornado

emergency system (including communications and procedures) operated as intended, and the identification of possible improvements that could save lives in future tornadoes.

4.2.1 Data on Public Response

Information on the public response before the tornado hit was obtained primarily through qualitative interviews. Several factors were taken into account when selecting the best method for collecting data on public response. Based on our understanding of how individuals make decisions during disasters, it was of interest to identify not only the information received by individuals and their responses to this information, but also the meanings that they developed (i.e., their situational awareness) and how these meanings influenced decision-making processes during the storm. Therefore, qualitative interviews were conducted via telephone or face-to-face meetings with survivors and friends and families of victims who experienced the storm. These interviews were conducted to collect detailed descriptions of individuals' experiences with their environment and the meanings that they generated as the tornado event was unfolding around them.

Interviewees were recruited for participation in the NIST investigation by several means. NIST published a *NIST Tech Beat* newsletter article describing the study that was posted on the NIST website and emailed to subscribers of NIST email alerts.¹⁰⁴ While in Joplin, interviewers posted flyers in and around the Joplin area and participated in interviews with Joplin area news outlets, including newspaper, television, and radio sources, which resulted in feature stories on the NIST technical investigation. Also, assistance in getting the word out was provided by several emergency officials and business or faith-based organizations within the Joplin area. In each recruitment strategy, NIST asked survivors and family or friends of victims of the May 22, 2011, Joplin tornado to please call, text, or e-mail so that NIST might interview them about their tornado-related experiences. NIST interviewers also called and traveled to local businesses to ask management about their interest in and availability for interviews. This very visible public recruitment enabled NIST to interview willing participants from a variety of geographic locations throughout the Joplin area, including some who had been displaced by the storm. Individuals interested in telling their stories were pre-interviewed to ensure that they in fact were located (or knew of someone who was located) in or near the damage path during the tornado.

After careful consideration, it was determined that a semi-structured interviewing technique best fit the requirements of this investigation. Highly structured (HS) interviews contain a fixed set of questions, often with set response options, and are mainly used to collect quantitative data that allow for ease of data comparison from one interview to the next. However, a HS instrument was deemed as unfeasible in this investigation due to the speed at which the NIST team began instrument development and, at that time, the lack of systematic analysis of Joplin survivor accounts (e.g., available in the media) necessary for the development of this type of instrument. Unstructured interviews, on the other hand, are conducted more like a conversation between the interviewee and interviewer, where very little structure is provided by a question set. Unstructured interviews allow for the collection of rich, powerful descriptions of the event; however, very little opportunity to compare one interview response to another (which was necessary here). The semi-structured interviewing technique allowed for the collection of rich, detailed data on tornado experiences (and the ways in which these experiences are interpreted by the interviewee) as well

¹⁰⁴NIST Tech Beat article: "NIST Seeks Help in Understanding Public Response to Joplin Tornado" (www.nist.gov/el/disasterstudies/joplin-101311.cfm).

as the opportunity to compare similar types of data. Additionally, this interviewing technique allowed for the discovery of phenomena and causal patterns that were not originally anticipated, and helped interviewees retrieve more comprehensive and accurate memories of incidents.

This semi-structured approach was conducted in two phases. In the first phase, respondents were asked to describe their experiences from the time when they first became aware that something was wrong until the moment when they responded to the disaster, such as by evacuating a building or sheltering in place. They were asked to speak freely about their experiences (what they saw, what they did, what they were thinking). The second phase was more structured, in that the interviewer asked follow-up or clarifying questions about important topics from a pre-established list of probing questions. The list of questions was developed by collecting and analyzing over 100 media accounts of May 22, 2011, Joplin tornado eyewitness survivor stories as well as by conducting some brief, initial interviews (17 in total) with survivors 5 days after the storm. The probing questions were used to ask about the following topics: awareness of the event, emergency communications received, actions taken, risk perceptions, pre-existing or event-driven injuries or impairments, previous experiences with severe storms, and familiarity with and perspectives on the emergency communications system in Joplin.

In total, NIST interviewed 168 survivors of the tornado, through a combination of in-person and telephone interviews.¹⁰⁵ The respondents ranged in age from 18 to 88, with a mean age of 51. Gender was also distributed, with women making up 59 percent of the sample. A geographic analysis of where respondents were located during the tornado showed that the sample was well distributed across the tornado's path through Joplin, with a small percentage located outside the area of tornado damage (i.e., EF0 to EF4 wind speeds zones). Interviewees were also widely distributed by physical setting during the storm: approximately 67 percent were at their or someone else's home (or apartment), 14 percent were in a private business, 7 percent were driving or stopped in a vehicle, 5 percent were in St. John's Regional Medical Center (SJRMC), 5 percent were in Joplin area churches, and the remaining 2 percent of the sample were either located outside of buildings or did not specifically state where they were located as the storm struck.

A portion of the survivor interviews (10 percent) was conducted with managers and employees of local businesses and institutions, including individuals in positions of authority at SJRMC. Information on organization-wide tornado emergency procedures, structural damage to facilities, sheltering options, and previous experience with emergencies was obtained from these interviews. Additional information on emergency procedures and tornado response was obtained from two interviews with SJRMC administrators and one interview with a senior manager of corporate security at the Home Depot. However, these three interviews were not counted among the total of 168 Joplin survivor interviews because, during the storm, these interviewees were not located within the area in Joplin exposed to the tornado.

A portion of the survivor interviews provided information regarding individuals who died from the storm. Seventeen of the 168 survivor interviewees (10 percent) provided information about the circumstances of a decedent before the tornado hit. In addition, two individuals not included in the 168 interviewees were interviewed by NIST regarding the circumstances of two fatalities of this storm, even though the interviewees, themselves, were not directly exposed to the tornado.

¹⁰⁵ The 168 participants also included 11 survivors who e-mailed their stories to NIST.

Finally, a portion of the 168 interviewees was injured by the storm. A total of 16 of the 168 interviewees specifically mentioned suffering a major, longer-term injury from this storm that required hospital attention. Other interviewees sustained only minor injuries or no injuries at all.

Relevant data were also collected by the National Weather Service (NWS), via face-to-face interviews selected using a convenience sampling technique, and the interviewers' written notes were provided to NIST in electronic form. No personally identifiable information was provided to NIST from any of the NWS interviews. The NWS also conducted interviews with businesses that suffered damage in the storm, to inquire about emergency procedures and the steps taken on May 22nd to protect people from harm. Most interview information collected by the NWS was verified by NIST via interviews with others in similar circumstances before being included in this report.

The interviews conducted by NIST constituted a "convenience sample," because they were performed with specific persons of interest, persons who volunteered to participate, or interviewees who were suggested to NIST by those who volunteered. There are limitations associated with this interview sampling strategy. The development of a convenience sample limits the ability of the researcher or analyst to generalize the findings to others affected by this tornado (others to whom NIST did not speak) as well as to other tornado disasters. These limitations on the ability to generalize were reduced by ensuring that certain topics (i.e., experiences with the tornado on May 22, options for protective action, and previous experiences with and perspectives on warning systems and tornadoes) were saturated, in that similar information was consistently collected as the interviews continued. Additionally, NIST analysts ensured that the convenience sample varied by age, geographic location throughout the damage path, and physical setting during the event (i.e., home, business, outdoors, or vehicle), further reducing the limitations of this dataset.

Data on decedents' experiences before and during the tornado were an important aspect of this study. Therefore, attempts were made to interview family members and friends of the victims to obtain information on their understanding of the event and the decedents' responses. Additional information on public response, especially in relation to the deceased, was obtained from the following sources: newspaper articles; books (*Kansas City Star* 2011; *Joplin Globe* 2011; Turner and Hacker 2011); social media, including Facebook accounts for tornado recovery and decedents' profile pages; and obituaries. This data collection effort is described in further detail in Sec. 4.2.2.

4.2.2 Data on Consequences of the Tornado—Injuries and Deaths

Information on casualties was also obtained to identify the pattern, locations, and causes of fatalities and injuries (the main objective of this chapter). To understand the circumstances surrounding the deaths, NIST collected data and information from its interviews with friends and families of tornado victims (described above), the Missouri State Police Department, the American Red Cross (Disaster Health Services), Facebook pages of the deceased and pages dedicated to the Joplin recovery, stories recorded in three books published on the tragedy (*Kansas City Star* 2011; *Joplin Globe* 2011; Turner and Hacker 2011), a LexisNexis obituary search, and death certificates for all victims of the tornado (provided to NIST by the Missouri Department of Health and Senior Services (MDHSS), the Oklahoma State Department of Health, and the Kansas Department of Health and Environment's Office of Vital Statistics). The death certificates provided the most information on the deceased, including place of

injury, time of injury, description of injury, place of death, time of death, cause of death, gender, occupation, education, and marital status.

To understand the circumstances of the more than 1,000 injuries resulting from this tornado, two datasets were obtained. Both datasets were provided to NIST by the MDHSS Division of Community and Public Health. The first dataset, entitled ESSENCE, included syndromic surveillance data, or data obtained from a systematic process of timely data collection and analysis in order to detect and characterize outbreaks of disease in humans. The ESSENCE database on the May 22, 2011, Joplin tornado injuries contains 762 records from residents of Jasper and Newton Counties and 114 records from persons residing outside of these counties. The dataset provides the following data on each injured party: gender, age range, and category of the chief complaint (i.e., the reason the injured person went to the hospital).

The second injury-related dataset used by NIST was collected by the U.S. Centers for Disease Control and Prevention (CDC) for the MDHSS to investigate a number of reports of fungal skin infection in people who were injured by the May 22, 2011, Joplin tornado (this investigation was referred to as the CDC EPI-Aid Study). The CDC dataset included injury and personal data from a total of 87 individuals¹⁰⁶ randomly selected by the CDC from the ESSENCE dataset previously described. The data provided to NIST were acquired by the CDC from both medical record chart abstraction and face-to-face interviews. The hospital chart abstraction was based upon a list of 62 questions, which addressed the following topics: address, date of wound/injury, date/time of receipt of medical attention, hospital admission history, initial admit diagnosis, intensive care unit (ICU) admittance (and number of days in hospital/ICU), intubation records, evidence (if any) of fungal growth, additional details about the fungal growth (not used by NIST), evidence of other types of wounds, total number of wounds, location and context of wounds, other injuries noted in addition to wounds, pre-tornado risk factors, treatment received, and outcomes (including information on deaths). Experiential data from the tornado event were collected by the CDC via face-to-face interviews with the injured (or family/friends of the injured). Interviewees were asked to describe what happened from the time the tornado started until the time the injured individual sought medical care, and to provide answers to more specific questions about their location during the storm, the type of structure in which he or she was located (including its construction type and information about the foundation and sheltering options, if in a home), the type of damage that occurred to the structure, and the methods the injured individual used to obtain protection from the storm (if any).

There are limitations to the data collected on injuries resulting from the May 22, 2011, Joplin tornado. First, the ESSENCE dataset focuses on individuals who visited the emergency room or used the emergency department services of a hospital. The ESSENCE dataset contained a total of 876 records, whereas other sources have estimated over 1,000 injuries resulting from this tornado¹⁰⁷. Since every injury might not have required emergency hospital services, it is likely that injuries occurred that were not included in this dataset, and thus, not obtained by NIST. Second, these datasets were not collected by NIST and, therefore, did not contain all of the information sought by NIST in its investigation. For example, the causes of the injuries listed in the ESSENCE database were very general in nature, making

¹⁰⁶ Data on only 71 injured participants from this dataset were used by NIST because some of those in the original 87 were deceased, and thus were included in the fatalities sample, or were provided to NIST with insufficient information for further analysis.

¹⁰⁷ *Community Press Kit* issued for the Day of Unity observance, May 22, 2012, <http://www.joplintornadoanniversary.com/resources/community-press-kit.pdf>.

them difficult to use in this investigation. Also, and more importantly, the ESSENCE database did not contain information about where each individual was located when he or she was injured, limiting the analysis that NIST could perform with this larger dataset of 876 injured individuals. Therefore, NIST primarily used the CDC dataset (i.e., the set of 71 out of the original 87 injured persons). However, there were also limitations associated with the CDC dataset, including the fact that the individuals were selected from the ESSENCE database, which had not been finalized when the CDC study was performed. Due to the limitations of the injury data, NIST used these data only to support the findings presented on fatalities, rather than to derive findings about injuries.

4.2.3 Data on Emergency Response

In addition to data collection efforts focused on public response and tornado consequences, investigative interviews were also held with emergency response personnel. These interviews were conducted as unstructured interviews, i.e., without a set of prescribed questions, that focused on a particular topic about which the interviewee had expertise. Emergency response personnel were asked about Joplin–Jasper County’s tornado emergency communications system at the time of the May 22, 2011, Joplin tornado, its method of operation, and emergency plans specifying appropriate public protective actions in tornadoes. Also of interest was any information on Joplin’s history with tornadoes and severe storms, including the number of times that sirens sounded (in the past) on a yearly basis. Interviews were held with representatives from the Joplin–Jasper County Emergency Management office, the City of Joplin Fire Department, the City of Joplin Police Department, and Missouri’s State Emergency Management Agency (SEMA). In addition to the information obtained in interviews, NIST obtained copies of the City of Joplin’s and Jasper County’s local emergency operations plans.

4.3 JOPLIN, MISSOURI, BEFORE THE TORNADO OF MAY 22, 2011

Joplin, Missouri, is a relatively small city (approximately 30 square miles) situated within Jasper and Newton Counties, which are located in the southwestern part of Missouri. Jasper County is bordered by Newton (to the south), Barton (to the north), and Dade and Lawrence Counties (to the east), and by the State of Kansas to the west. See Chapter 1, Fig. 1–1 and 1–2 for maps of Joplin and surrounding areas. Joplin is the fourth largest metropolitan area in Missouri, with a population of 50,150 (U.S. Census Bureau 2010).

According to the City of Joplin’s and Jasper County’s local emergency operations plans, Joplin and Jasper County are exposed to many types of hazards. Possible natural hazards, in addition to tornadoes, are flooding, drought, wildfires, and severe winter storms. In any type of emergency, it is the responsibility of the local government to provide for public safety in the event of a disaster. If the emergency exceeds the local government’s capability to respond, assistance is then requested from the State government. The City of Joplin and Jasper County created emergency management organizations

that are responsible for the preparation and implementation of emergency management functions for their jurisdictions (Stammer 2013¹⁰⁸).

The Joplin–Jasper County Emergency Management office was (and still is) located in the business district of Joplin, an area not damaged by the tornado. It was established based upon Missouri Revised Statutes Chapter 44, Civil Defense, Sec. 44.080, which states that “All political subdivisions shall establish a local emergency management organization.”¹⁰⁹ A political subdivision can be defined as a fire district, village, town, city, or county. There are approximately 1,400 political subdivisions within the State of Missouri (Stammer 2013¹¹⁰). Most political subdivisions appoint their fire chief as emergency manager, and others have an emergency manager who serves on a part–time basis. It is the role of the emergency manager of each subdivision to make decisions on response plans, recovery procedures, the emergency communication system, and when to activate this system in emergencies.

Even though the emergency manager for the City of Joplin holds the title of “Joplin–Jasper County Emergency Manager,” his or her authority on emergency communications and procedures is limited to the City of Joplin. (The city provides, under a contract with the county, emergency management services to the county at large for those political subdivisions that do not have dedicated emergency management officials or those that require guidance.) Therefore, every political subdivision within Jasper County can potentially have significantly different emergency communication systems and emergency plans and procedures.

4.3.1 Emergency Communications—Outdoor Siren Systems

Prior to May 22, 2011, the City of Joplin had developed emergency plans on how to alert and warn individuals in the event of a tornado (SEMA et al. 2011). Joplin and the 11 other communities within Jasper County had outdoor siren devices. Such devices consist of a network of sirens (also known as civil defense or air raid sirens) stationed at multiple points throughout the county, city, or community that produce a pattern of sounds to alert individuals of impending hazards. An outdoor siren system can also include loudspeakers to broadcast voices, horns, or whistles. Figure 4–1 shows the type of siren used in the Joplin area, model #2001–130 from the Federal Signal Company. These sirens were not equipped with the capability to disseminate voice announcements to the community, thus the system existed as an alerting system only (i.e., without the capability of providing warning information to the public).

There were 25 sirens in the City of Joplin’s outdoor system; 23 were located within the City of Joplin, and one each was located in Duenweg (siren located at 20th and Duquesne) and the Village of Airport Drive (note: each of these sirens belongs to the respective city, but they are tied into the Joplin system). If a decision were made to sound the sirens for an emergency affecting the Joplin area, all 25 sirens connected to Joplin’s system sounded simultaneously. However, there was no interconnection between the sirens in Joplin’s system and those located in other parts of Jasper County. Siren locations for the City of Joplin are shown in Fig. 4–2. These sirens were spaced at a radius of 1 mile, per guidance

¹⁰⁸ Keith Stammer, emergency manager for Joplin/Jasper County, personal communication, 2013.

¹⁰⁹ Missouri Revised Statutes, Chapter 44, Civil Defense, Section 44.080 (www.moga.mo.gov/statutes/C000-099/0440000080.HTM).

¹¹⁰ Keith Stammer, emergency manager for Joplin/Jasper County, personal communication, 2013.

provided by the Federal Emergency Management Agency (FEMA) guide CPG 1–17, *Outdoor Warning Systems Guide* (1980), and were set at a decibel rating of 130 dB at 100 ft.

© 2011 Federal Signal.
Used with permission.



Figure 4–1. Model #2001–130 Siren from the Federal Signal Company.

Figure 4–2. Siren locations for the City of Joplin.



During a tornado emergency, the Joplin Communication Center Dispatch, which is located in the Joplin–Jasper County Emergency Operations Center (EOC), is responsible for activating the 25 outdoor sirens. The sirens can be sounded only after the communications operator has been notified by weather monitor, weather pager, teletype, or public safety personnel that a “tornado has been sighted or a tornado warning has been issued by the NWS for Jasper, Newton, or Cherokee County. The sirens will also be sounded if sustained winds are 75 mph or higher” (SEMA et al. 2011, Annex B). The policy, according to the Joplin–Jasper County Emergency Management director, is to sound the sirens as early as possible, and if conditions look close to those specified above, he or she will decide to sound them (Stammer 2011¹¹¹). Joplin’s outdoor siren system is not sounded for any types of emergencies other than tornadoes or severe windstorms.

For activating the sirens anywhere within Jasper County, there are two 9–1–1 call centers: one in Joplin (located in the Joplin EOC) and one in Carthage (Jasco 911). Political subdivisions within Jasper County can either operate their sirens locally or through the Carthage call center. Usually, sirens are activated by

¹¹¹Keith Stammer, emergency manager for Joplin/Jasper County, personal communication, 2011.

the authorities in each political subdivision, i.e., the police chief or fire chief physically activates the sirens.

FEMA's *Outdoor Warning Systems Guide* was the only guidance that NIST found on the use and testing of outdoor warning (or siren) systems. FEMA updated this guide in 2006 (FEMA 1980, 2006). These FEMA documents suggest that, for a local incident (e.g., a tornado), an attention or alert warning should be given by sounding sirens, horns, or other sound-producing devices continuously for 3 min to 5 min. At the time of the May 22, 2011, Joplin tornado, the practice in Joplin was to alert the public of an emergency by sounding the outdoor siren system continuously for 3 min and then turning off the sirens. The City of Joplin's system was not designed to issue an "all-clear" message via the sirens or any kind of public address announcement. Additionally, the FEMA guidance suggests that the outdoor siren system be tested on a monthly basis, and that during the test, the test signal should sound for no more than 1 min in the "Attention/Alert" mode (i.e., continuous sounding). This initial test signal should be followed by 1 min of silence, and then the test should be concluded by sounding the "Attack" warning (i.e., a warbling sound) for no more than 1 min. In Joplin, there was no difference in sound or tone for different types of wind events (i.e., the sirens were sounded in the same manner for straight-line winds and for tornadic, circular winds). In addition, the sirens were tested on a weekly basis in Joplin, weather permitting, at 10 a.m. on Mondays. During the test, the sirens were activated in tornado/windstorm mode (i.e., sounded continuously) for a period of 1 min and then turned off.

The FEMA documents also provide guidance on the meaning of the attention/alert tone, stating that this mode is supposed to signal that all persons in the area should turn on the radio or television and listen for essential emergency information. In Joplin, the siren system was not meant to alert people located inside of buildings. Rather, the siren system was meant to alert people located outside to take cover, to hide, or to move into buildings (if possible), preferably sturdy buildings with a secure area (Stammer 2011,¹¹² Scrivner 2011¹¹³). If people indoors wished to receive alerts, the Joplin-Jasper County emergency plans suggested the use of a weather radio.

NIST reviewed how use of the outdoor siren system in Joplin compared with use of similar systems in other communities in Missouri and across the United States. Information from the emergency management websites of more than 75 U.S. counties, cities, and towns equipped with outdoor (siren) systems was compared, showing that use of these systems differs in four main ways from Joplin's operations at the time of the May 22, 2011, Joplin tornado:

- Joplin's siren system was primarily used for tornadoes and other windstorm events, while some communities throughout the nation use these systems for other types of disasters, including national security events, chemical spills, and tsunamis.
- Joplin relied primarily on information from the NWS, while some communities rely only on local officials and/or trained weather spotters to decide when to activate the siren system.
- Differences exist in the sounds disseminated by sirens from community to community. Joplin used a continuous tone over a finite, 3 min time period, whereas other communities sound their

¹¹²Keith Stammer, emergency manager for Joplin/Jasper County, personal communication, 2011.

¹¹³Randy Scrivner, emergency manager with the State of Missouri, personal communication, 2011.

sirens continuously using a repeating time interval (e.g., sound for 3 min, off for 8 min, sound for 3 min).

- Joplin used the same continuous tone for tornadoes and other windstorm events; however, other communities alternate different types of tones (continuous versus wavering, for example) and tone patterns (see bullet above) for different types of emergencies.

This analysis also revealed that tornado communication systems and their uses often vary within the same State, and even among adjacent communities, and that some communities, especially smaller towns and rural areas (even within tornado-prone regions), do not have such systems. The variability in the design and use of emergency communication systems could make it difficult for citizens to understand, from city to city and even across cities within the same area, what type of disaster is imminent and what actions should be taken in response. This is especially the case among systems that lack explanatory public address announcement capability. Traveling to locations where different emergency communication procedures exist can cause confusion and the potential for more severe consequences, like injury and death. See Appendix K for more detailed findings from this review.

One possible reason for the differences in outdoor warning, alert, or siren system use among communities is the lack of Federal, State, or industry standards or requirements on system use and subsequent public responses. National codes and standards relevant to tornado siren systems mainly provide requirements for the construction, installation, and maintenance of these systems. Whereas previous guidance was provided in the annex, only the latest edition of the National Fire Protection Association's (NFPA) *National Fire Alarm and Signaling Code* (2013) provides general requirements on message writing and dissemination for emergencies (not specific to tornadoes). See Appendix L for additional details on codes and standards for outdoor tornado warning systems. With no Federal, State, or industry requirements and very little guidance, outdoor siren policies vary from community to community throughout the United States (Coleman et al. 2011).

4.3.2 Emergency Communications—Other Modes of Communication

In addition to the outdoor siren system, prior to May 22, 2011, Joplin had access to additional communication modes for tornadoes. First, the Joplin Police Department and Jasper County 9–1–1 centers had “Reverse 9–1–1” capabilities. Reverse 9–1–1 calling was developed to allow emergency management agencies (at the local level) to contact individual households via landline phone systems and cell phones to warn them of impending disasters. This system uses a database of landline telephone numbers, cell phone numbers (only if subscribers provide them), and addresses that are each tied to a specific geographic location. Emergency managers use this information to deliver recorded emergency notifications to a selected set of telephone service subscribers, based upon the location of the disaster. Even though Joplin was equipped with this technology, the emergency manager noted that the local phone switches could not always handle the volume of calls necessary in a timely manner and it had taken up to 3 hours to get emergency calls out in previous uses. Therefore, this technology was not used on May 22, 2011 (Stammer 2011¹¹⁴).

¹¹⁴Keith Stammer, emergency manager for Joplin/Jasper County, personal communication, 2011.

All three of the local television stations in the Joplin area had mobile web opt-in accounts that sent out emergency information to the communication devices of individual subscribers in the event of an emergency. These mobile warning services require that individuals sign up to receive the alerts and warnings, which can often be delivered to as many devices as the subscriber chooses, including e-mail- or text-enabled devices.

Individuals in Joplin (especially those located indoors) could also be alerted to weather information through a National Oceanic and Atmospheric Administration (NOAA) weather radio (NWR). The NWR All Hazards Network is a network of radio stations that broadcast continuous weather and hazard information, including official NWS warnings, watches, and forecasts, on a 24-hour-a-day basis. The broadcast information comes directly from the nearest NWS local office in the form of computerized-voice weather broadcasts to an NWR receiver, although there are variations of this receiver device for the deaf or hard of hearing. It is the responsibility of individual users to voluntarily purchase this device and maintain it in working condition. There are no Federal, State, or local requirements for public or private buildings or residences to own a functioning NWR receiver. Instead, NWRs are made available for purchase in many retail outlets.

For individuals with access to these media, weather information was also broadcast via radio and television. In some cases, meteorologists convey information directly from the NWS or from their own weather models, and in other cases, news anchors convey weather information provided to them from other sources. It should be noted that television and radio stations in the United States are under no obligation to provide severe weather information to the public. While the Federal Communications Commission licenses broadcasters to operate in the public's interest, and most television and radio stations do provide severe weather information to varying degrees, there is no Federal or State law requiring local broadcasters to provide tornado warnings to the public before or during an emergency.

In times of emergency, the Joplin-Jasper County Emergency Management office could also take advantage of communications via the Emergency Alert System (EAS).¹¹⁵ The EAS is a national public warning system requiring broadcasters, cable television systems, wireless cable systems, satellite digital audio radio service providers, and direct broadcast satellite providers to allow communication capability to the President in national emergencies. State and local authorities can also use the system to deliver important weather information targeted to specific areas.

In either case, for individuals to receive emergency information via television or radio, they must be proactive and search for it. Emergency information disseminated via television and radio is accessed only when people seek it out or are already tuned into these sources for some other reason and inadvertently receive weather information. With that said, in most cases where information is unclear, ambiguous, or scarce, the public will take time to seek additional information from a variety of channels.

Similarly, individuals in the Joplin area could have received weather information through various online sources, if they sought it prior to the storm. For example, the NWS provides advisory, watch, and warning information via various websites and e-mail and social networking accounts, such as Twitter. Many news and weather sites post the most current emergency messages (either directly from the NWS or written in their own words) as well as other emergency-related information.

¹¹⁵Federal Communications Commission: "Emergency Alert System" (<http://transition.fcc.gov/pshs/services/eas/>).

4.3.3 Sheltering Procedures for Tornadoes

Prior to May 22, 2011, Joplin had developed guidelines on in-place sheltering for residents in the event of tornadoes or other types of technological or natural hazards (SEMA et al. 2011). The guidelines acknowledge that tornadoes present situations in which people should shelter in place. The responsibility for heeding warnings and taking appropriate actions falls on individual communities and citizens. The emergency plans for Joplin state that, although there is no guaranteed safe place during a tornado, “the safest place in the home is the interior part of the basement, preferably under something sturdy, like a table. If a basement is not available, an inside room on the lowest floor, like a closet or bathroom with no windows, should be used” (SEMA et al. 2011, K–8).

The housing stock in Joplin (especially along the tornado damage path) provided very little in the way of underground shelter options. Few houses (17 percent, or 1,237 out of 7,411 damaged homes located within the damage path) had basements, partial or full. The many near-surface mine tunnels¹¹⁶ and other unfavorable soil conditions (high water table and limestone just below the surface¹¹⁷) made it difficult for builders to include basements in many homes throughout the Joplin area. In addition, very few individuals invested in in-home shelters. There was, however, a significant number of homes with crawl spaces (80 percent, or 5,904 out of 7,411). Crawl spaces are typically located under the first floor of the house, sometimes but not always underground, and provide access to pipes, substructures, or other areas of the house not easily accessible. The height of crawl spaces can be as small as 1 ft and most crawl spaces are typically accessed externally (residents must go outside of the house to enter the space).

No stand-alone or within-building public shelters were located in Joplin at the time of the tornado. This may have been due, at least in part, to the lengthy and complicated steps involved in obtaining a FEMA-funded public shelter, including showing FEMA the building schematic, developing operation and maintenance procedures, creating plans for notifying the public, and showing that individuals can access the area by car in less than 5 min travel time.¹¹⁸ However, there are three FEMA-funded community shelters located in Newton County, adjacent to Jasper County, which were built to FEMA standards.

4.3.4 Tornado History in the Joplin Area

Prior to 2011, the City of Joplin had experienced one tornado rated EF-2 or higher since the beginning of official tornado record keeping in 1950. A recorded F-2 tornado directly affected the City on May 5, 1971. Information about this tornado was detailed in a book, which is available online (Knapp and Boone 1971), and a summary description of this event is provided in Chapter 1 of this report.

Although the City of Joplin had never experienced a tornado causing the levels of death and damage that were sustained on May 22, 2011, tornadoes were a familiar sight in the area surrounding Joplin prior to 2011. Since 1950, 182 tornadoes rated EF-2 or higher had struck within an 80-mile radius of Joplin.

¹¹⁶ City of Joplin Building Official, personal communication, 2011.

¹¹⁷ Reuters, “Without basements, Joplin had scant refuge from tornado” (www.reuters.com/article/2011/05/31/us-tornado-basements-idUSTRE74U6HT20110531).

¹¹⁸ FEMA, personal communication, 2011.

This included three tornado events rated EF-3 or higher. The first of these occurred on April 3, 1956, when an F-4 tornado caused 118 injuries and likely millions of dollars in damage according to the NWS Storm Prediction Center (SPC) database. Second, a May 4, 2003, tornado outbreak included two tornadoes that were rated F-3 and passed within 25 miles of Joplin, causing 17 fatalities, 116 injuries, and over \$95 million in damage. Third, a May 10, 2008, event consisted of two EF-4 tornadoes that were within the Joplin region, but outside Joplin's city limits. These tornadoes caused a total of 43 fatalities and 710 injuries, and the total damage was estimated at \$122 million.

Even more familiar than tornado events to residents of the region around Joplin has been the issuance of NWS tornado warnings. NWS-issued warning information is primarily disseminated to the Joplin population via NWRs, the EAS, television or radio broadcasts (or associated mobile-based opt-in services), and Internet sites, including the NWS website for the Springfield (Missouri) Weather Forecast Office (WFO). Between July 1, 2005, when storm-based (or polygon) warnings were first being tested in Springfield, and May 25, 2011, the NWS issued 18 tornado warnings for all or some part of Joplin. Only 4 of these 18 NWS tornado warnings (shown as blue polygons in Fig. 4-3) were followed by verified tornadoes. This yielded a false-alarm rate for the Joplin area of 0.78, or 78 percent (14 false alarms out of 18 warnings). This rate is similar to the long-term average false-alarm rate for the Springfield WFO (0.774). For the era of storm-based warning 2007 to 2011, the national average false-alarm rate was 0.747, or 74.7 percent.

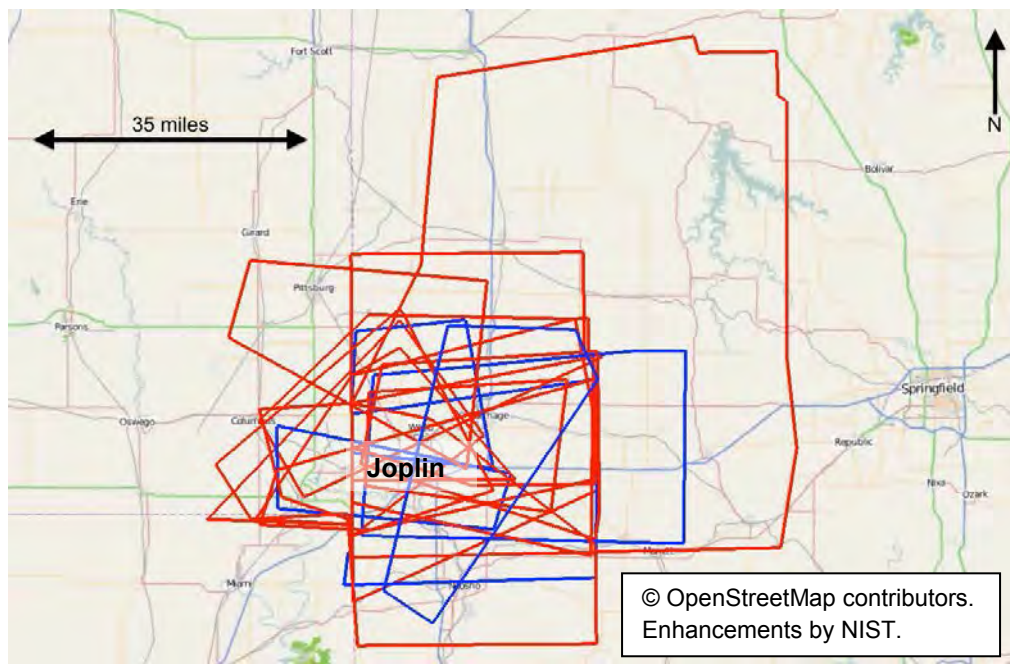

Figure 4-3. The polygons associated with the 18 tornado warnings issued by the NWS between July 1, 2005, and May 25, 2011 (false alarms shown in red, warnings followed by verified tornadoes shown in blue).

During the 5 years preceding May 22, 2011, the NWS issued 12 storm-based tornado warnings for Joplin. These warnings were issued on the following nine dates: June 8, 2007; March 31, 2008; May 10, 2008; May 24, 2008; June 4, 2008; April 9, 2009; June 9, 2009 (three warnings that day); June 3, 2010;

September 16, 2010; and May 12, 2011. Of these 12 warnings, only 1 (May 10, 2008) was verified as an actual storm event. Therefore, over the most recent 5-year time period, the false-alarm rate for NWS warnings for Joplin was 0.917 (about 92 percent of warnings were false alarms).

It is also important to determine the number of times per year that the sirens sounded in Joplin. Counting the weekly tests, except for instances when the weather was already bad, the test sirens sounded approximately 52 times per year. Also, according to the Joplin–Jasper County emergency manager, the average has been once per year (at most) since 2007 (Stammer 2013¹¹⁹). In 2007, the sirens sounded once in Joplin for severe thunderstorm winds in excess of 70 mph (on January 18, 2007). The next year, the sirens sounded for an EF–1 tornado that hit outside the Joplin city limits (on May 10, 2008). Then, in 2009, the sirens sounded on May 8 due to winds in excess of 85 mph. The next time the sirens sounded, according to the emergency manager, was on May 22, 2011. Therefore, it can be concluded that the emergency manager for Joplin was not sounding the sirens for every tornado warning issued by the NWS for all or some part of Joplin, but rather was making siren–activation decisions based on other factors as well. Also, the emergency manager did sound the sirens for the one warning that was verified in the Joplin area (prior to May 22, 2011) since 2007. In the meantime, sirens were tested on a weekly basis, each Monday morning at 10 a.m., sounding for 1 min each time.

An understanding of the false-alarm rate, the history of siren soundings, and the history of tornadoes is important because it can provide insight into public behavior in response to tornadoes. Because sirens and tornado warnings often do not convey the severity of the storm, large numbers of false alarms (even for weak storms) can lead to public complacency (Wang and Kapucu 2008). Residents and visitors in the Joplin area who received NWS–issued tornado warnings were exposed to false alarms 92 percent of the time, based on the most recent 5 year period. Additionally, although tornadoes had occurred in and around the Joplin area, the City of Joplin had only experienced the strength of EF–2 (or F–2) or lesser storms before May 22, 2011.

4.4 JOPLIN, MISSOURI, ON MAY 22, 2011—THE TORNADO HITS

This section of the report tells the story of the public response to and the consequences resulting from the deadly tornado that hit Joplin, Missouri, on Sunday, May 22, 2011. Even though the NWS SPC in Norman, Oklahoma, began forecasting storms for the area up to 3 days prior, this account begins that Sunday morning and ends when the tornado left the Joplin city limits at approximately 5:50 p.m. that evening. In this section, we look to the survivors of the May 22, 2011, Joplin tornado, since they either experienced the event firsthand or have knowledge of the experiences of family members or friends who experienced this tragedy.

The weather that Sunday morning was described as beautiful. As people woke up and began their day, the sky was blue, the sun was shining, and there were only a few clouds in the sky. It was, however, unusually hot and humid for May, described by one interviewee as a “summer day” in the spring (NIST Interview 102¹²⁰).

¹¹⁹ Keith Stammer, emergency manager for Joplin/Jasper County, personal communication, 2013.

¹²⁰ See Section 4.2.1 of this report on information pertaining to NIST interview data and data collection methods.

Joplin was bustling with residents and visitors attending to their Sunday activities at home or elsewhere. Places of worship were open, with some, like the Full Gospel Church and Harmony Heights Baptist Church, holding both morning and evening services. Local retailers open that Sunday included Dillon's grocery, Home Depot, and both local Walmarts, among others. Restaurants and specialty food shops opened for the breakfast and lunch crowds, and expected greater-than-usual patronage in the afternoon following the Joplin High School graduation ceremony to be held at Missouri Southern State University (MSSU). Hospital staff tended to patients at SJRMC, located in the southwestern part of Joplin (inside the path that the tornado would later take through the city), and at Freeman Hospital, located to the south of SJRMC (outside the path of the tornado). The emergency communications timeline (displayed in Chapter 2 as Fig. 2–6) shows that Joplin's first official tornado-related emergency message on May 22, 2011 was delivered at 1:30 p.m. However, people had been made aware of the possibility of storms on Sunday, via weather reports, as early as Friday, May 20, 2011. On Sunday afternoon, at 1:30 p.m., the SPC issued a tornado watch for a large area of northwest Arkansas, southeast Kansas, eastern Oklahoma, and southwest and central Missouri, which included Jasper County. Once a severe thunderstorm watch or warning or tornado watch or warning was issued for the Joplin area, EOC dispatchers notified all police officers on duty, the fire department, and emergency management officials. However, since an incident in 2008 when a volunteer spotter was killed in Newton County, the City of Joplin has not assigned spotter locations to police officers or other officials (and did not do so on May 22, 2011) (Stammer 2013¹²¹). Any police officers who provided information on the May 22, 2011, Joplin tornado were already on duty in certain areas inside and outside of the city.

The SPC issued a "moderate" risk of severe storms for the area described above at 3 p.m. However, the weather in Joplin still did not provide much evidence of the possibility of afternoon storms. Some people noted the presence of clouds, even with the sun shining, but the only indication of something brewing that afternoon was the existence of slightly darker clouds in the sky to the west of Joplin.

Residents at home spent the afternoon watching television programs or movies, eating or preparing dinner, doing chores, getting ready to leave (for work or church, for example), or sleeping. Some were monitoring the weather at this time, checking the radar via the Internet or switching back and forth between the Weather Channel and local weather or news sources.

Other people were out and about throughout Joplin, pursuing their Sunday engagements. Some were working the afternoon or evening shifts at local Joplin restaurants, businesses, and hospitals. Others were completing their Sunday errands at local Joplin businesses or attending local religious services or study sessions. Additionally, the high school graduation ceremony was being held at MSSU, located in the northwestern part of Joplin.

By 5 p.m., the weather had begun to change in Joplin. The sky became overcast and cloudy, and some of the people later interviewed by NIST (especially those who had been located farther to the west) described the conditions as stormy or rainy. One interviewee, who was outside at the time, noticed that conditions to the west "looked very strange—sort of a yellowish-greenish color (not typical)" (NIST Interview 129). At 5:09 p.m., the NWS's Springfield WFO issued a tornado warning (see Tornado Warning Polygon 30 in Chapter 2, Fig. 2–5) that focused on a storm cell affecting northeast Joplin, from which a tornado never resulted. The text of this warning message can be found in Appendix M.

¹²¹Keith Stammer, emergency manager for Joplin/Jasper County, personal communication, 2013.

Individuals receiving this tornado warning were also made aware of the possibility of storms to the northwest of Joplin, specifically identified as heading toward Carl Junction, Missouri. The EAS was initiated with this tornado warning. Two minutes later, at 5:11 p.m., the 25–siren alert system was activated throughout the City of Joplin. As mentioned earlier, the sirens sounded for 3 min with a continuous tone, and then stopped. The decision to activate the siren alert system was made based on conversations between emergency management officials of Cherokee County and Joplin–Jasper County, information from the NWS that they were going to issue a tornado warning for Jasper County (the warning that was disseminated at 5:09 p.m. for Tornado Warning Polygon 30, affecting northeast Joplin), the direction of travel of that tornado, and anecdotal information from a local emergency official (outside of Joplin) regarding the destruction being caused by that particular storm (Stammer 2011, 2013¹²²).

The NWS’s Springfield WFO issued another tornado warning at 5:17 p.m. This warning was issued for Tornado Warning Polygon 31 (see Chapter 2, Fig. 2–5), which included southwest Jasper County and the entire City of Joplin (the text of this message can also be found in Appendix M). The EAS was also initiated with this second NWS warning. Approximately 21 min later, and as the tornado entered the Joplin city limits (at 5:38 p.m.), Joplin’s 25–siren system was sounded a second time. Even though the Joplin–Jasper County emergency procedures did not specify the use of a second tone, the decision to sound the sirens a second time was made based upon discussions between Joplin–Jasper County Emergency Management (EM) and the Joplin Fire Department regarding an NWS statement on the size and intensity of the tornado in Tornado Warning Polygon 31. Shortly after the second siren sounding was initiated, KOKC radio (a local radio station in the Joplin area) called Joplin–Jasper County EM. As the EM office was answering the station’s question as to why the sirens were going off a second time, the telephone call cut out and the EM representative was unable to complete his explanation. It is suspected that the tornado had eliminated telephone communications. According to Joplin–Jasper County EM, this was the only time that they had direct communication with any media outlet before the tornado tore through Joplin. After the tornado hit, Joplin’s public information officer was stationed at the EOC for approximately 4 weeks, answering requests from media outlets and getting information out to the public.

The 5:09 p.m. tornado warning for northeast Joplin, the 5:11 p.m. siren alert, and the subsequent emergency information delivered via these and other communication channels (including the tornado warning issued at 5:17 p.m. and the second siren alert activated at 5:38 p.m.) began a series of response behaviors in the Joplin area. The receipt of certain types of emergency information related to the tornado varied depending upon where individuals were located within the Joplin area, which in turn, influenced their perspectives on the storm and resulting response behaviors. Therefore, it is important to correlate the narratives of survival obtained by NIST with the narrators’ physical locations throughout the Joplin area between the times of 5:09 p.m., when the first set of emergency communications was delivered, and 5:50 p.m., when the tornado left Joplin.

The Missouri State Police Department provided to NIST a list of names and locations of the 161 individuals who lost their lives due to the May 22, 2011, Joplin tornado.¹²³ Table 4–1 provides information about where these victims were located during the tornado.

¹²² Keith Stammer, emergency manager for Joplin/Jasper County, personal communication, 2011 and 2013.

¹²³ Originally, 162 names were provided to NIST by the Missouri State Police; however, months after the tornado occurred, one of the names was removed for not being associated with the Joplin tornado.

Table 4–1. Distribution of fatalities based upon location of injury/death^a from the May 22, 2011, Joplin tornado listed in alphabetical order by location name.

Locations of Injury/Death ^a	Number of Victims	Percentage of Victims
AT&T store	1	0.6 %
Elks Lodge	4	2.5 %
Full Gospel Church	4	2.5 %
Golden Corral	1	0.6 %
Greenbriar Nursing Home	19	11.8 %
Harmony Heights Baptist Church	3	1.9 %
Home Depot	8	5.0 %
Meadows Healthcare facility	2	1.2 %
Outside (12 in vehicles)	20	12.4 %
Pizza Hut	5	3.1 %
Residences: apartments	12	7.5 %
Residences: homes (detached)	62	38.5 %
Stained Glass Theater	3	1.9 %
St. John’s Regional Medical Center	14	8.7 %
Walmart	3	1.9 %
Total	161	100.0 %

a. Location where the victim was killed or sustained the injury that led to his or her death.

The locations that are featured in the following sections are those where all but 3 of the 161 tornado–related fatalities¹²⁴ occurred: the Elks Lodge where 4 people died, SJRMC where injuries sustained that day led to a total of 14 fatalities, the Stained Glass Theater where 3 perished, the Greenbriar Nursing Home where injuries led to a total of 19 deaths, places of worship (the Full Gospel Church and Harmony Heights Baptist Church) where a total of 7 died, the AT&T store where 1 life was lost, the Home Depot where 8 deaths occurred, the Pizza Hut that was the site of 5 deaths, Walmart store #59 where 3 lives were lost, private homes and apartments where 74 perished, and in vehicles and outside of structures where a total of 20 people died (see Fig. 4–4). The circumstances encountered at these locations by survivors and decedents are chronicled, and supplemented by stories from people who survived in other Joplin locations under similar circumstances. Quotes taken directly from survivors’ detailed accounts are used as support for findings and to provide additional detail where necessary.

¹²⁴The circumstances surrounding the remaining three deaths are discussed in Sec. 4.4.12, below.

These narratives are also supported by the data collected on injuries. Table 4–2 identifies the location when injured of the 71 individuals from the CDC dataset whose data were used by NIST in relation to where the deaths occurred in Joplin, as well as the severity of their injuries. NIST considered that the severely injured could have endured similar circumstances as those who died from injuries sustained in the tornado. With that in mind, a “severe” injury was categorized as one for which the person was hospitalized for eight or more days or admitted to a hospital ICU for any length of time (Sugerman 2012¹²⁵). Additionally, to distinguish among the individuals categorized with “severe” injuries, the number of days that they spent in the ICU was also recorded. From the sample of 71 injuries, 49 percent were categorized as “severe,” 41 percent were categorized as “non–severe,” and 10 percent were of unknown severity. As stated earlier, NIST used these data only to support the findings presented on fatalities, rather than to derive any additional findings about injuries.

4.4.1 Elks Lodge

Located relatively close to the beginning of the tornado path in Joplin, at 1802 West 26th Street, Joplin Elks Lodge #501 contained a lounge where drinks were served, a restaurant, a billiard room, and a larger room where bingo was often held on Sunday afternoons.¹²⁶ Five people were in the wood–frame building when the storm hit, and four of the five perished in the tornado (Stefanoni 2011). The building, which was subjected to an estimated maximum wind speed of approximately 170 mph \pm 20 mph, was destroyed by the tornado (Fig. 4–5).¹²⁷ No interviews were collected by NIST or the CDC from the only survivor located in this building; however, NIST gathered media reports on the circumstances inside the lodge as well as information from an interviewee who was friends with one of the persons killed in the lodge.

According to this interviewee (NIST Interview 82), and as corroborated by data from Red Cross interviews, one of the deceased walked into the Elks Lodge, yelling about the tornado as it was approaching the lodge. At that point, all five individuals inside the building started to run for the cooler; however, none of them made it inside the cooler in time. Four of the five died from impact–related injuries caused by multiple blunt–force trauma to their bodies, according to the death certificates. Reports on the casualties at the lodge note that the roof collapsed on top of the occupants (*Kansas City Star* 2011). One of the decedents worked at the lodge as a bartender. The one individual who survived was sheltered by her husband, who laid his body over hers when the storm hit the building. She sustained serious injuries.

4.4.2 St. John’s Regional Medical Center

SJRMC was also located toward the beginning of the tornado’s path through the city. The facility consisted of two complexes with eight different buildings (see Chapter 3, Fig. 3–6). The north complex comprised five buildings: the West Tower (building #1 on Fig. 3–6); the East (Patient) Tower (building #2); the Emergency Generator building (building #3); the Chiller Plant (building #4); and the Oncology Clinic building (building #5). The south complex included three buildings: Medical Office Building (MOB) 1 (building #6 on Fig. 3–6); MOB 2 (building #7); and the Physicians Office Building (building

¹²⁵ David Sugerman, Medical Officer in the Division of Injury Response of the CDC, personal communication, 2012.

¹²⁶ Elks USA, “Local Lodges Online” (www.elks.org/lodges/lodgefacilities.cfm?LodgeNumber=0501).

¹²⁷ Unless noted otherwise, the average maximum wind speeds cited in this chapter were estimated by NIST based upon the wind field model described in Chapter 2.

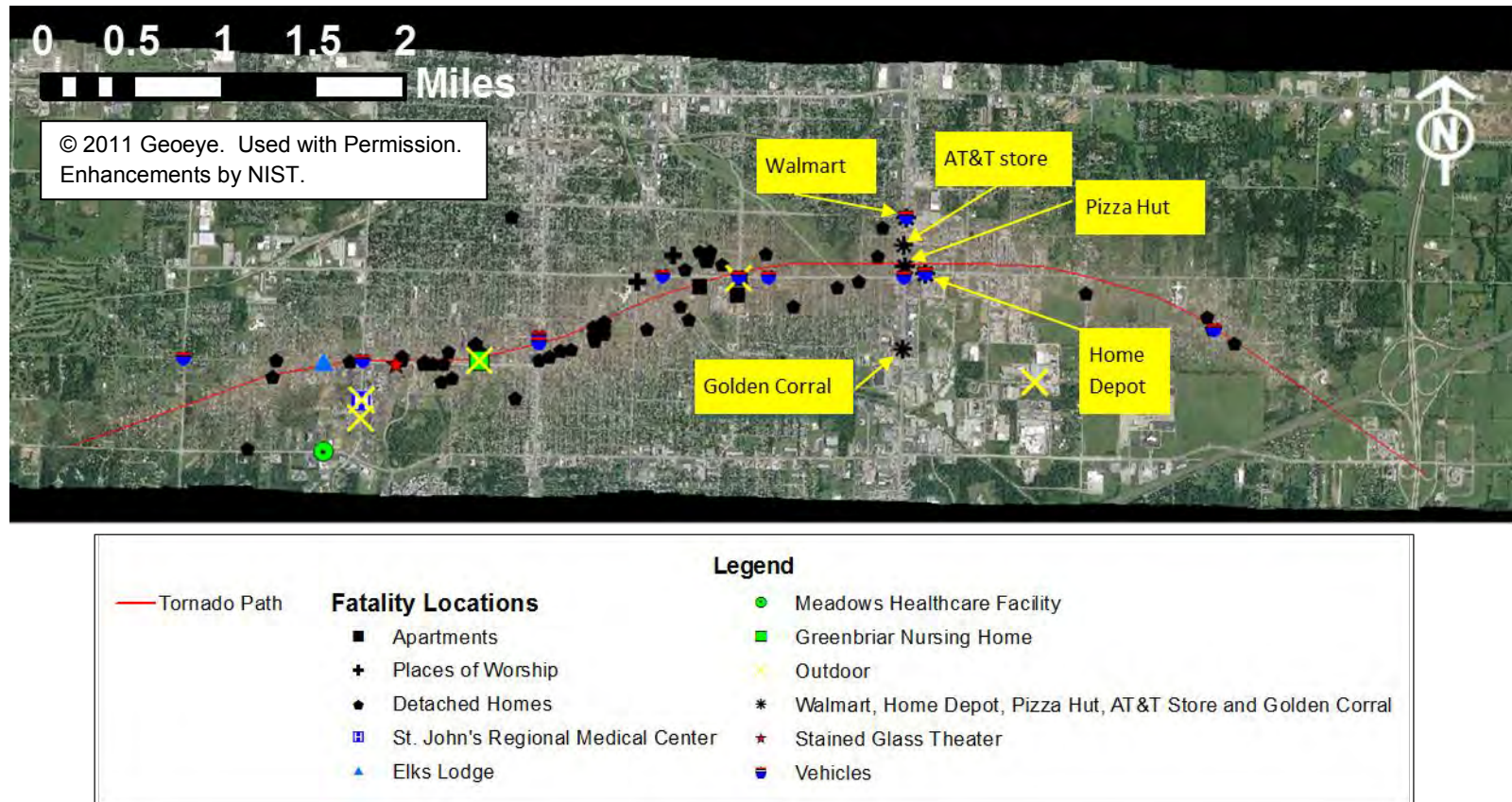

Figure 4–4. Locations of the 161 fatalities resulting from the May 22, 2011, Joplin tornado. Tornado estimated center track plotted in red.

Table 4–2. Distribution of injured persons based upon locations of sampled injuries and all fatalities from the May 22, 2011, Joplin tornado.

Location	Number of Injured (from sample)	Number of Severely Injured (from sample)
<i>Locations Where Fatalities Occurred</i>		
AT&T store	1	1 unknown ^a
Elks Lodge	–	–
Full Gospel Church	1	1
Golden Corral	–	–
Greenbriar Nursing Home	5	5
Harmony Heights Baptist Church	–	–
Home Depot	–	–
Meadows Healthcare facility	–	–
Vehicles (only)	18	8
Pizza Hut	–	–
Residences: apartments	3	1
Residences: homes (detached)	32	18; 5 unknown ^a
Stained Glass Theater	1	1
St. John’s Regional Medical Center	5	1 unknown ^a
Walmart	1	1
<i>Locations Where There Were Injuries but No Fatalities</i>		
Payless Shoesource store	2	–
7th Street Walmart	1	–
Dillon’s Grocery store	1	–
Total	71	35 (known)

a. In a few locations, it was not possible from the available data to identify the severity of one or more injuries.

#8). See Chapter 3 for information on the design and construction of these facilities. The focus of this section is the behavior of the building occupants in both patient towers—the West Tower (seven-story building) and the East Tower (nine-story building)—before and during the May 22, 2011, Joplin tornado.

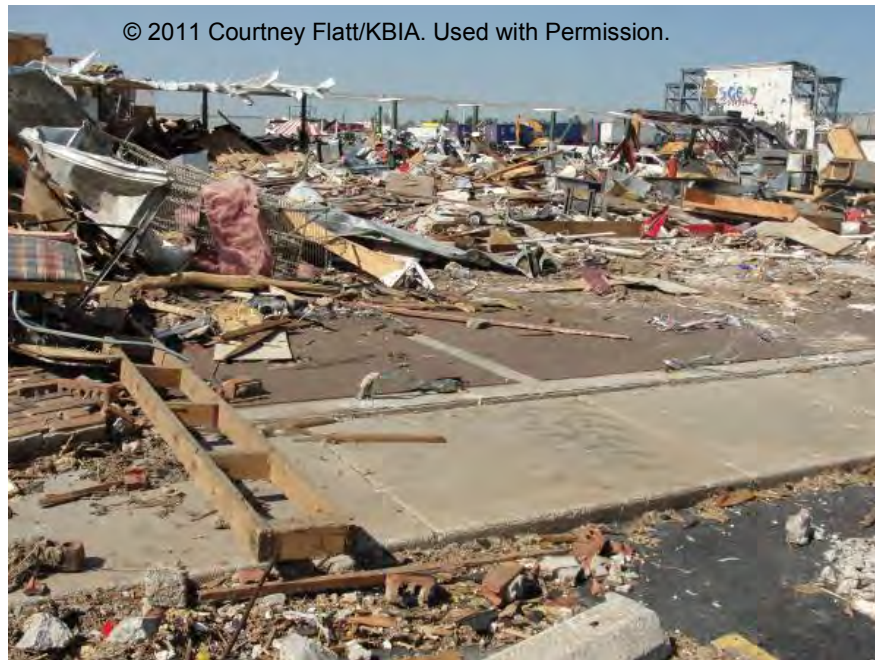

Figure 4–5. Joplin Elks Lodge #501 destroyed by the May 22, 2011, Joplin tornado.

In the event of severe weather, hospital emergency procedures in the East and West Towers called for a two-phase approach (NIST Interview 7). The first phase, called “Prepare for Condition Gray,” was activated when there were storms in the area or there was the potential for storms. “Prepare for Condition Gray” was intended to prompt hospital staff to perform preparatory actions, such as closing the drapes and blinds to protect people from glass breakage, and informing patients and visitors that they should stay away from windows and other glass around the hospital. The second phase of the emergency procedures was referred to as “Execute Condition Gray.” Activation of this phase meant that there was severe weather in the area and there was the potential for a storm to hit the hospital. In this stage, patients were moved from their rooms into the hallways. If they were ambulatory and able, they moved to chairs already placed in the hallways. If they were unable to move themselves, their bed was moved to the hallway, with the head of the bed raised (and the back of the raised portion of the bed facing the windows) to provide additional protection from flying debris. Pillows and blankets were also used for protection.

NIST collected narratives from medical staff, patients, or visitors on all floors of the hospital, except the fourth floor (i.e., a total of 10 individuals who had been on either the east or west side of each floor). In addition, information was collected from the hospital’s risk manager and the head nurse on duty responsible for the activation of the hospital’s emergency procedures. According to the risk manager, hospital “staff had kind of been on the alert all afternoon that there certainly was potential for severe weather” (NIST Interview 7). However, instead of being notified of the tornado warning from the hospital switchboard, which was the procedure in place, the head nurse received information about the tornado warning by hearing the outdoor sirens from her office inside the hospital. What she heard was likely the second round of sirens, activated at 5:38 p.m., since she only remembered hearing sirens one time and noted having only 5 min to 7 min between the time she heard the sirens and the time when the

tornado hit the hospital (NWS User/Business Interview 8¹²⁸). When she heard the sirens, she told hospital security to Execute Condition Gray, which was announced over the hospital's public address system.

No other narratives collected by NIST, including those obtained from hospital staff, patients, and visitors, mentioned hearing the sirens from inside the buildings. Interviewees did, however, mention hearing and responding to the Execute Condition Gray announcement. Doctors, nurses, and staff began protecting patients and themselves by moving individuals from their rooms into the internal hallways on each floor (CDC Injury Interview 13A¹²⁹). A patient located on the east side of the hospital on the sixth floor, for example, had just received word from her doctor that she was being released:

The alarm went off. And she just stopped, and I said, "What are they telling us?" Cause it was a different sound than I had heard. She said they're telling us that there's a tornado. She said, "We aren't going anywhere . . .," so when they rolled me out into the hall and parked me there. (NIST Interview 53)

But not everyone inside the hospital recalls hearing the Execute Condition Gray message. A couple had been waiting in the first-floor Emergency Room waiting area for 4 hours, when they recall that the hospital staff "finally got us down into an examining room" (NIST Interview 2). The couple was aware of the fact that Joplin was experiencing some bad weather, mainly rain and winds, but had no idea that a tornado was heading their way. Shortly after they were placed in the examination room, the husband felt his ears pop, which prompted him to shelter his wife underneath the examination room sink/cabinet fixture. Then, they heard a sound like a freight train (NIST Interview 2).

When the tornado hit the towers, the buildings were exposed to average maximum wind speeds of 170 mph (with lower and upper bounds of 125 mph and 210 mph). On the third floor (east), a visitor, her brother, and her father were located in the interior hallway when she heard the sound of the hallway door blowing open as the tornado hit. She looked down the hallway, witnessing everything from the west end of the hospital flying into the east end, where they were taking refuge:

There were medical equipment, x-rays, chairs, etc., flying towards us. All we thought about was covering dad and protecting him. My brother put himself in front and over dad, I was over his back side and a nurse was covering the side of him. The wind was tremendous at that point. The next thing I remember is trying to not fly out of the window and thinking this can't last much longer, they always say it is over in just a few minutes. Then a door from the room hit me in the back and made me fall to the ground. (NIST Interview 105)

A woman in the hallway on the sixth floor (east) recalls being "pelted ferociously in the head with baseball size hailstones, broken glass, insulation, and tons of debris." She and her husband, a patient in the hospital, protected themselves, as much as possible, with ceiling tiles and other flying debris that they could hold over their heads until the storm was over (NIST Interview 106).

¹²⁸ See Section 4.2.1 of this report on information pertaining to NWS interview data and data collection methods.

¹²⁹ See Section 4.2.2 of this report on information pertaining to CDC data and data collection methods.

After the tornado passed and the winds subsided, the conditions inside the hospital made it obvious that evacuation was necessary (NIST Interview 6). Many of the patients had been hurt badly (NIST Interview 106). The floors had been so damaged, and individuals so injured, that hospital staff realized they needed to find other locations in which to provide medical care (NIST Interview 7). A doctor described the conditions on the sixth floor of the West Tower in the following way:

Walls in, doors in, door frames in, debris everywhere. You can't imagine the shattering that goes on when you have materials exposed to that kind of wind. Plus just the wires that were down from the ceiling, all the equipment that's inside a room, debris a foot, two feet deep some places that you had to move before you could get somebody out . . . but instantly without any thought you knew you were leaving this place because it was just absolutely wrecked. (NIST Interview 6)

When the couple in the first-floor Emergency Room made it out of their examination room, they noticed the rain just pouring in from where the ceiling used to be. With water at their ankles, and live wires sparking around them, they were concerned about being electrocuted if they remained in the building for much longer (NIST Interview 2). See Fig. 4-6 for an example of damage done to the interior of the SJRMC.

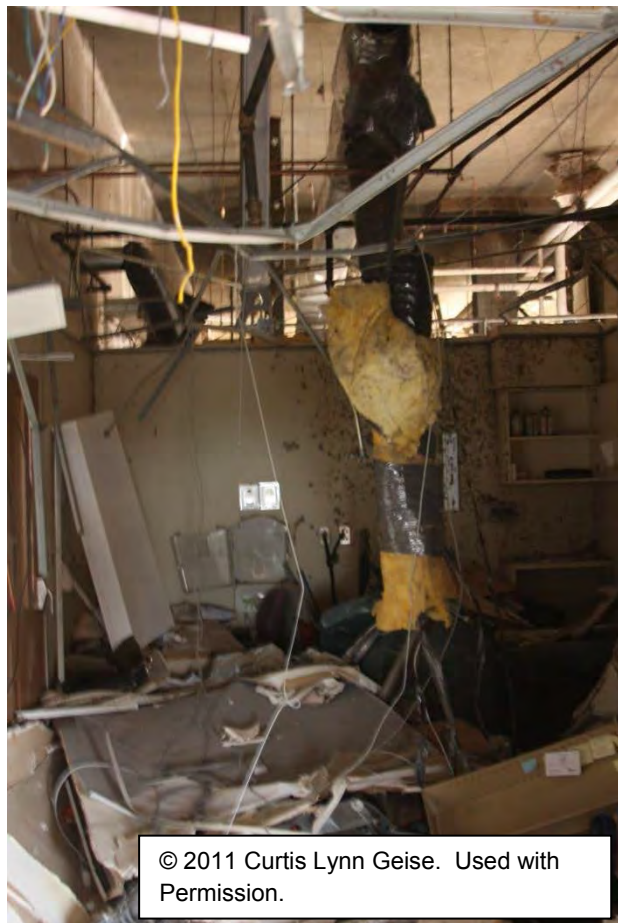

Figure 4-6. Damage to the interior of SJRMC.

Prior to May 22, 2011, when an evacuation was considered necessary, the administrative supervisor normally would have made the decision and announced it using the overhead building-wide public address system (NIST Interview 7). However, this system was not available for use due to a full loss of power throughout the hospital (see Chapter 3 for information on this loss of power). Additionally, debris and other building damage made it difficult to move through the buildings and verbally announce decisions to evacuate (or not). Therefore, it is speculated that many of the hospital staff quickly realized that the towers could no longer provide proper medical care for the patients, and thus, would have to be evacuated (NIST Interview 7). At this point, the only option available for evacuation was vertical evacuation via the towers' four stairwells, since the elevators were non-operational (NIST Interview 7). A doctor on the sixth floor noted that he and his staff decided on their own to evacuate their floor, while another hospital staff member on the second floor noted that she and her colleagues were told by a firefighter walking through the building to evacuate their floor (NIST Interview 18).

Some staff members had more difficulty than others evacuating their floors. The psychiatric ward, for example, had mainly ambulatory patients who could evacuate easily. The cardiac and neurological floor, on the other hand, had patients who could not walk, so it was difficult for them to evacuate (NIST Interview 6). The operating room, located on the second floor, took 3 hours to 5 hours to evacuate because many of the patients were not ambulatory (NIST Interview 18). Staff first helped those who could walk down the stairs and out of the building. The occupants used flashlights, cell phones, and lighters while going down the stairwells because they were very dark and full of debris. All staff members are supposed to carry flashlights; however, not everyone had one at the time of the tornado. On the neurological floor (sixth floor of the East Tower), they used the medical tool that is normally used to check patients' pupils to provide light for navigating down the stairs.

Also on the neurological floor, for the first 30 min after the tornado, the staff tried to get people out from under the rubble (NIST Interview 6). Patients stuck under water pipes were rescued first to prevent the possibility of hypothermia. After 45 min, a firefighter and other people from the community came to the floor to help evacuate the injured. This floor was the last to evacuate because a majority of the patients were mobility impaired and could not walk.

Hospital staff used whatever they could find to carry the injured patients down the stairs and out of the hospital. The neurological floor used wheelchairs to bring the patients down the stairs. Four uninjured staff or members of the community would carry the injured person in the wheelchair down the stairs. There were a few patients on the sixth floor who weighed over 300 pounds. It was very difficult for the four people to carry and maneuver those patients down in the wheelchairs. Emergency medical technicians also brought in backboards with plastic handles to carry people out. However, one doctor mentioned his dislike for these boards because they were very flexible and hurt his hands when carrying patients down the stairs. Some patients were carried down on doors that had blown off of hinges. Med Sleds® were also used to transport patients down stairways, although not in the way they were intended to be used (NIST Interview 7). Med Sleds® are designed to allow two people to easily slide a patient down stairs. Once the patient is safely out of the building, the sled can be slid back up the stairs. However, the staircase must be clear. Because there was debris all over the stairs and it was also so dark, it was difficult to steer the sleds down the stairs and four people had to carry the patient on these devices during the SJRMC evacuation.

After evacuating the hospital, patients were taken by bus, pick-up truck, or other types of vehicles to local hospitals. When the hospitals within and around Joplin became full, patients were taken to other hospitals located throughout Missouri, as well as Kansas and Oklahoma.

A total of 14 deaths was attributed to SJRMC as a result of the May 22, 2011 Joplin tornado. Five individuals died on May 22, 2011, due to impact-related causes, i.e., multiple blunt-force trauma to the body, according to the death certificates. Of these five, all of whom were patients, four were located in critical care (or intensive care) units on the third or seventh floors of the hospital, and the other was located on the third floor, but not in intensive care (NIST Interview 7). In a media interview of a nurse working on the seventh floor of the hospital during the storm, she recalled seeing hospital staff standing over patients who were originally on mechanical ventilators and bagging them (manually ventilating them) after the storm had hit the hospital.¹³⁰ Seven of the deaths attributed to SJRMC were of people injured at the hospital due to multiple blunt-force trauma to the body and who died days, weeks, or months later in other hospitals, according to the death certificates. Finally, two individuals suffered heart attacks in the storm at SJRMC and died either days or weeks later in other hospitals. It has been confirmed that at least one of these two individuals was a patient at the hospital before the storm hit.

4.4.3 Stained Glass Theater

The Stained Glass Theater was a playhouse located in Joplin at 1318 West 26th Street, very close to SJRMC. Late in the afternoon of May 22, 2011, the cast and crew had just finished a performance of “I Remember Mama.” As the cast was taking a curtain call, around 5:11 p.m., the first set of outdoor sirens sounded. These could be heard from inside of the theater. There were 56 people in the building when the tornado hit. NIST spoke with five individuals who were there, and one family member of a person who died at the theater that day.

At curtain call, the theater’s director walked on stage to let the audience, cast, and crew know that there were sirens sounding in the City of Joplin. In an interview, an audience member tried to recall the director’s statement in the director’s own words:

“The tornado is northwest of us and looks like it’s heading northeast.”
Then she went on to say, “Now, the sirens are going on,” and at that point, yeah, we could hear the sirens. That was—again, as far as I know that was the first siren. The—she said that, “We have a strong building here and anyone who wants to stay is welcome to do so. We can all go down in the basement.” (NIST Interview 121)

According to another interviewee, most of the patrons decided to leave (NIST Interview 120). One couple in particular thought about it for a short while, and then based upon the information the director provided as to the direction of the storm and the location of their house, they calculated that the tornado would likely miss the theater and their house, and they would much rather be home than anywhere else (NIST Interview 121).

¹³⁰ YouTube video, “Nurse kept patients safe during tornado” (www.youtube.com/watch?v=74YFLjcVfxk&feature=relmfu).

Since this had been the final performance of this play, many of the cast and crew decided to stay and help take apart the set (NIST Interview 120). One couple who worked concessions that day was among those who stayed (NIST Interview 115). They rationalized this decision with the knowledge that the tornado was located to the north of them (and they were located in the southern part of Joplin), and the fact that they were located in a sturdy building. They mentioned that the average tornado that they had witnessed prior to May 22, 2011, would never have damaged the theater building. Instead, they were used to a tornado hitting “a building or two . . . three or four or something, but no major damage like this one” (NIST Interview 115). An actor in the play also admitted that “I didn’t put much stock in that siren, because I’d heard them before, and 9 times out of 10, you hear the sirens but nothing really happens” (NIST Interview 120).

Approximately 25 min after the first announcement, the theater director delivered a second message to those remaining in the theater. She announced that there was bad weather and “we want you to get to the basement right now” (NIST Interview 115). The basement stairs were approximately one-person wide, and not everyone made it down the stairs before the theater was hit by the tornado.¹³¹

They weren't rushing and pushing to get down those stairs. People were very nice, just getting over there in line and going down the stairs as quickly as they could. But there just wasn't time to get that amount of people down. (NIST Interview 115)

A couple who did not make it to the basement in time, and thus suffered injuries from the storm, threw themselves on the floor of the theater, in between theater row seats, which were bolted to the floor. Their recollection of the seats was that they “just bent over enough that it—I think it kind of sheltered us from—we got the wind and everything, but I think it sheltered us from being taken out” (NIST Interview 115). The couple mentioned getting pummeled by debris over and over again: “just going across my head and back and everything from razor blades just cutting me. You know? And just felt awful, and I just didn't like—I didn't think anyone could make it through this” (NIST Interview 115). Eventually, something hit her husband in the head, rendering him unconscious for a while. Another interviewee survived in the lobby bathroom of the building (NIST Interview 120), located in the northeast corner of the theater building (the corner opposite from where the storm hit). He survived the storm “huddled up in a fetal position on the floor in the restroom,” mentioning that the storm never lifted him up into the air, but instead pushed him down into the ground as it passed overhead.

The theater, an unreinforced masonry building with brick facade, was exposed to average maximum wind speeds of approximately 170 mph from the tornado. Three theater occupants lost their lives due to injuries sustained from the tornado. The director, who was standing at the top of the basement stairs when the building was hit, was fatally injured that day (NIST Interview 115). According to the death certificate, the director died one week later in the hospital. The other two deaths occurred during the storm, caused by multiple blunt-force trauma to the body, according to the death certificates. According to interviewees, neither of these victims made it to the basement before the tornado hit (NIST Interview 115). Six others were seriously injured at the theater; however, it is not known where they were located within the building when they were injured.

¹³¹ In NIST Interview 115, it was reported that approximately 15 people made it into the basement before the building was hit. NIST was unable to obtain information about how many people were located in the building when the tornado hit; but it should be noted that there were individuals who, while they did not make it into the basement, survived inside the building.

There were no NWRs or televisions inside the theater building. It is unclear whether the theater had a radio, nor is it clear how the director and others were obtaining information about what was going on with the weather. One interviewee mentioned checking the weather on his iPhone before the performance began, but did not mention using this to obtain information after the sirens sounded (NIST Interview 120).

The Stained Glass Theater was not the only building in Joplin that had access to an underground basement area. The Macadoodles wine shop, located at 3105 East 17th Street, contained an underground wine cellar that patrons and staff used to shelter from the May 22, 2011, Joplin tornado. Two Macadoodles staff members were interviewed by NIST and provided the following information about how they received word of the storm and where they took shelter (NIST Interviews 17, 131).

Prior to May 22, Macadoodles management had decided that the wine cellar would be the safest place to go in the event of a tornado. Six customers (including a baby) and six managers and employees were in the store at the time of the May 22, 2011, Joplin tornado. Five minutes after the tornado sirens sounded for the second time, the lights started flickering and the occupants were discussing how the wind was picking up and it was getting dark outside. Someone from outside of the store entered and told the occupants that “the other side of town had been hit and it was heading straight toward us” (NIST Interview 17). Additionally, the manager of the store, looking out the front windows, could no longer see the cars parked in front, since it was raining so hard. It was at that moment that the manager, with help from other employees, led the six customers downstairs and into the wine cellar. As soon as everyone got downstairs, the power went out completely, and a flashlight was used to move everyone underneath the basement staircase:

We were all hunkered together down. And one of the guys had a little boy who was going to be like a year old the following week, so he was down on the floor with the baby and we were all around him. You know, I mean we had kind of our arms around each other like that. You know, part of it was because we didn't know how bad it was going to be and we just wanted to make sure we were holding together to protect that baby. (NIST Interview 17)

No injuries or fatalities occurred in the Macadoodles that day, even though the wood-frame building, with wood roof trusses, was demolished by the storm. The building was exposed to average maximum wind speeds of approximately 150 mph.

The wine cellar was a big, 1,000 ft² basement-like structure, encased in concrete, approximately 20 ft deep (NIST Interview 131). It was accessed via a large oak stairway. The cellar was open during business hours so that customers could shop for the high-priced wines kept at cooler, cellar-level temperatures. It was an open area, in that customers could see into the wine cellar from the first floor.

Macadoodles did have a television in the store, which was tuned into the weather reports that afternoon, as well as a radio playing overhead, from which one of the interviewees recalled hearing EAS tones two different times.

4.4.4 Greenbriar Nursing Home

The Greenbriar Nursing Home was located only a few blocks east of the Stained Glass Theater, at 2502 South Moffet Avenue in Joplin. The Greenbriar, an unreinforced masonry building with wood roof trusses, was one of six nursing facilities within the City of Joplin. The nursing home suffered a direct hit from the tornado on May 22, 2011 (Tetz 2011), and was exposed to an estimated maximum wind speed of approximately 170 mph \pm 20 mph. NIST attempted to interview individuals who had been located in the nursing home before and during the storm, including management personnel, but was unable to do so. The information discussed in this section was obtained from media accounts and from CDC interviews of five individuals who were injured in the facility during the storm, conducted by the CDC as part of its EPI-Aid study (see Sec. 4.2.2 for more about the CDC study and dataset).

A total of 19 fatalities from the May 22, 2011, Joplin tornado are attributed to the Greenbriar Nursing Home, which was completely demolished by the tornado (see Fig. 4–7). All deaths were due to impact-related causes, except for one individual whose cause of death was pneumonia (and whose death occurred one month after the tornado hit), according to the death certificates. Five of the 19 fatalities were individuals who were injured at Greenbriar Nursing Home and later transported to hospitals where they died from their tornado injuries, according to the death certificates. No information was found on the exact cause of death for these five fatalities; only the cause of the injury that contributed to their death which was recorded on the death certificate. There was a media report that the cause of at least one of these five deaths was mucormycosis, a fungal infection that attacks the body after injury (Younker 2011a); however, NIST was not able to independently confirm that report.

According to media accounts (Tetz 2011), 85 residents were located in the nursing home when the tornado hit, assisted by 10 nursing home staff members. The facility's emergency procedures for tornadoes called for the staff to move residents to inner hallways and to close all doors to residents' rooms to block out flying glass (Younker 2011a).



© 2011 Missouri Health Care Association. Used with Permission.

Figure 4–7. The small brick wall in the foreground (to the left of the van) is one of the few portions of the Greenbriar Nursing Home left standing following the May 22, 2011, Joplin tornado. (The building standing in the background was not part of the Greenbriar.)

It is not known how the residents and staff received word about the tornado, or whether everyone took refuge inside the building. One of the reported refuge locations was the nursing home's central hallway. CDC interviews indicated that the staff placed as many residents as possible in the central hallway. According to media reports and CDC interviews, people located in this hallway became buried in rubble when the tornado hit. The ceiling, including pipes, plaster, wood, and whatever else was located above, came crashing down upon them. Additionally, where sections of the roof were blown off by the tornado,

people were lifted out of the building and sent flying by the storm's strong winds (Younker 2011a). It is unclear whether people were lifted from the central hallway or from other locations throughout the nursing home. Another location in which people reportedly took refuge was a small closet inside the nursing home (Younker 2011a).

4.4.5 Places of Worship

Although several places of worship were located within the tornado's damage path, there were two such places where fatalities occurred: Harmony Heights Baptist Church, located at 2025 Indiana Avenue in Joplin, and the Full Gospel Church, located at 1828 Michigan Avenue (also in Joplin, one block northeast of Harmony Heights Baptist Church) (see Fig. 4–8).

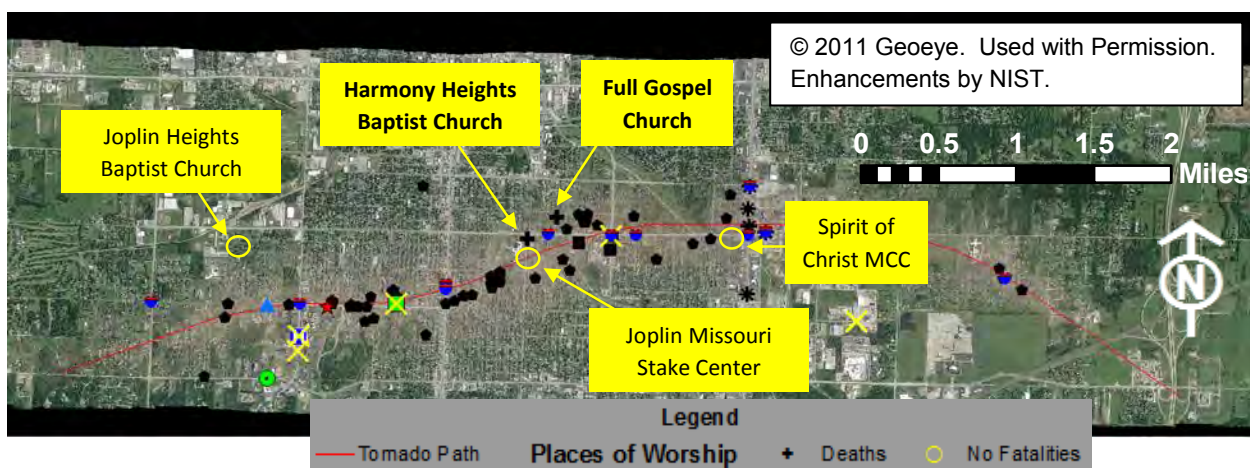

Figure 4–8. Locations of places of worship, denoted by black plus signs (+) where people died and yellow circles where there were no fatalities, along the tornado damage path (red line marks the estimated center line of the path).

NIST spoke with two individuals who attended evening services at Harmony Heights Baptist Church on May 22, 2011, and collected additional data from media accounts and Red Cross interviews. The evening service had begun at 5 p.m. and the pastor was getting ready to preach when the congregation¹³² heard the sirens sound outside. Although the first set of sirens prompted some discussion among attendees as to what was going on and what to do, the second set coincided with talk about tornadoes heard on the fire-department radios of off-duty firefighters who were attending the service (NIST Interview 22). The pastor then prompted people to go to a safe place, because the radio discussions had sounded serious (NIST Interview 22). Some attendees took shelter in the church library, while others went to the church nursery. Individuals in the library laid down on the floor and waited for the tornado to pass.

The Harmony Heights church building, which was a combination concrete masonry unit and wood-frame structure with wood roof trusses, was exposed to average maximum wind speeds of approximately 160 mph. Three women died in this building during the May 22, 2011, Joplin tornado, all from impact-related injuries. One woman was crushed to death in the children's nursery area, laying over her son

¹³² The number of people present at Harmony Heights Baptist Church on May 22, 2011 (before the tornado hit) has not been confirmed by NIST, although a media account cites 53 people (Word&Way 2012).

(who survived). Another woman was killed as she stood in the doorway of the nursery. An interviewee noted that the woman killed in the doorway was unable to shelter on the floor due to knee injuries. Another woman was pelted by debris and fatally injured as she laid on the floor of the church library (NIST Interview 22; Word&Way 2012).

The Full Gospel Church lost four of its parishioners in the tornado. This church, which occupied a wood-frame building, was exposed to an estimated maximum wind speed of 150 mph \pm 20 mph. Information on the circumstances at the church during the storm was obtained from media accounts, Red Cross interviews, and CDC interviews. No survivors from the Full Gospel Church were interviewed by NIST, and therefore, no information was gathered by NIST on how parishioners were made aware of the impending tornado. Information was acquired only on where the deceased were located at the time of death and the circumstances of their deaths.

As the storm approached the church, the 30-member congregation huddled and sang together in the church nursery (Babb 2011). When the tornado struck, the roof of the church flew away (Babb 2011), causing the walls of the structure to collapse onto the occupants. Four parishioners died that evening inside the nursery; two survivors specifically noted that the cause of these deaths was collapsing walls.¹³³ However, not all of the occupants took refuge in the nursery. One individual interviewed as part of the CDC EPI-Aid Study noted that he or she heard the sirens before walking into the church, got scared and immediately took refuge in the church bathroom.¹³⁴ As the tornado hit, this person was thrown from the bathroom along with a toilet stall, and he or she was subsequently hospitalized for more than 2 weeks due to blunt-force trauma and lacerations.

All deaths at Harmony Heights Baptist Church and Full Gospel Church were due to impact-related injuries (i.e., multiple blunt-force trauma to the body), according to the death certificates. Additionally, all of these individuals died on May 22, 2011.

NIST interviewed individuals who had been in other places of worship located throughout the tornado damage path. Patrons of the Joplin Heights Baptist Church, located at 2107 Willard Avenue in Joplin (almost completely outside of the tornado's damage path), took refuge in the interior hallway. An interviewee was prompted to look outside by the first round of sirens, which he dismissed, since there was "nothing odd about the sky yet" (NIST Interview 37). Walking around outside to study the clouds a bit later, he heard the sound of a freight train and immediately knew that a tornado was coming. He did not hear the second set of sirens, nor did he have a cell phone with him to check for information about the weather. At this point, approximately 15 individuals got into the hallway of the church building. The building (construction type unknown) sustained no damage after being exposed to average maximum wind speeds of approximately 80 mph. There were no fatalities attributed to the storm at Joplin Heights Baptist Church, and the interviewee suffered no injuries as a result of the tornado. According to the interviewee, the church building was composed of concrete block, and suffered very little damage from the storm (NIST Interview 37).

¹³³ This information was gathered via Red Cross interviews documented on American Red Cross Disaster Health Services Mortality Report Forms.

¹³⁴ The location of the bathroom inside the Full Gospel Church is unknown.

The Joplin Missouri Stake Center, located one block south of Harmony Heights Baptist Church on the tornado's estimated center line/track (at 2100 Indiana Avenue in Joplin), suffered a much higher level of damage (NIST Interview 73). This church, a wood-frame building with concrete masonry unit exterior walls, was hosting a meeting for single adults at the time of the tornado. When the sirens sounded (which the authors speculate had to be the second set of sirens), an interviewee looked to a weather application on his mobile device that showed a storm directly over the top of Joplin. He went to find the seven others in the building, and they all took refuge in the small women's restroom, "just off the baptismal font, which had no windows and four solid walls" (NIST Interview 73). He stated that, "having lived in Missouri for almost 30 years, I had experienced this routine before and was thoroughly expecting the storm to be another one that did no damage, and just passed us by, so I did not panic" (NIST Interview 73). As soon as everyone took refuge, he could hear the roar of the tornado as it approached. All eight laid down on the floor of the bathroom, when they

felt the roof lift off over our heads and forces lifting us skyward. Everyone's hair began standing on end and my suit coat jacket began billowing upward and it seemed that a giant vacuum cleaner had its sights set on lifting us out into the stormy sky. Someone reached out and grabbed my tie to keep me from being sucked out. After a few seconds, the vicious sucking was not as severe, but the winds continued with fury . . . flying cinder blocks flew into the opening and smashed the porcelain sink and toilet just beyond where we lay on the floor. Miraculously most of the flying debris missed us completely except for a cinder block that struck a blow to the top of my head and a piece of flying metal cutting [another person]. The air was filled with insulation, shingles, dirt, sand, and wood splinters. (NIST Interview 73)

Except for a few scrapes and bruises, there were no injuries among the eight people located in that bathroom during the storm. Most of the building around them had been destroyed, after being exposed to average maximum wind speeds of approximately 170 mph.

Parishioners participating in Bible study at the Spirit of Christ MCC, located at 2904 East 20th Street in Joplin (two blocks from the Macadoodles shop), had access to a basement for shelter during the storm (NIST Interview 63). The 10 attendees had just completed a study session when the sirens first sounded. They proceeded to check their mobile devices for weather information, and went outside to look for any environmental clues. They found nothing out of the ordinary. The weather information predicted some heavy thunderstorms but they saw nothing to worry about "except for a few clouds in the west." So they went back inside to finish their studies (NIST Interview 63). The interviewee also noted that "the sirens stopped going off, which typically if something is going on, they just stay on" (NIST Interview 63). It was not until the sky looked as if it was turning green, the wind had picked up, and the sirens sounded a second time, that the pastor decided that they needed to get everyone to the basement. At that moment, the windows began "popping out" (NIST Interview 63).

Only 8 of the 10 occupants made it into the basement before the storm hit; the other 2 suffered injuries. Both of the injured persons "dove into the floor in the bookstore where there was a couch. When [one] woke back up with the rain hitting his face, the couch was on the edge of the foundation with him hanging onto it. So they'd been pulled about 20 feet and yet, everything else [from the building] was gone" (NIST Interview 63). Both injured men had been hit in the head, and one of the two was knocked unconscious for some time before being woken up by the rain (NIST Interview 63). The Spirit of Christ MCC, a

wood-frame structure, was exposed to an estimated maximum wind speed of approximately 170 mph \pm 20 mph. No one was killed in this building from tornado-related injuries.

4.4.6 AT&T Store

One individual died the evening of May 22, 2011 at the AT&T store, a building constructed of metal-frame walls with brick facades, located at 1702 South Range Line Road in Joplin. NIST sought information from media accounts on the events that occurred inside the store. NIST's attempts to contact the AT&T company were unsuccessful.

Media reports stated that five employees were inside the AT&T store on the afternoon of Sunday, May 22, 2011, and that they were closing the store before the tornado hit (CWA 2011). According to these reports, the employees could hear tornado sirens from inside the store, and the first set of sirens prompted them to lock the store doors (Skinner 2011). The doors had been locked for 15 min when a family of six pulled up to the store. At that point, one of the employees noted that there was debris in the air. Employees unlocked the store doors and allowed the family (two adults and four children) inside. Everyone (five employees and the family of six) rushed into the men's bathroom located at the back of the store (Skinner 2011; CWA 2011). One of the employees tried to lock the bathroom door, but was unable to do so (Skinner 2011), and the tornado hit. They could hear glass breaking, likely from the storefront (Skinner 2011). As they huddled together, they began to hear what sounded like walls crashing down (see Fig. 4-9).

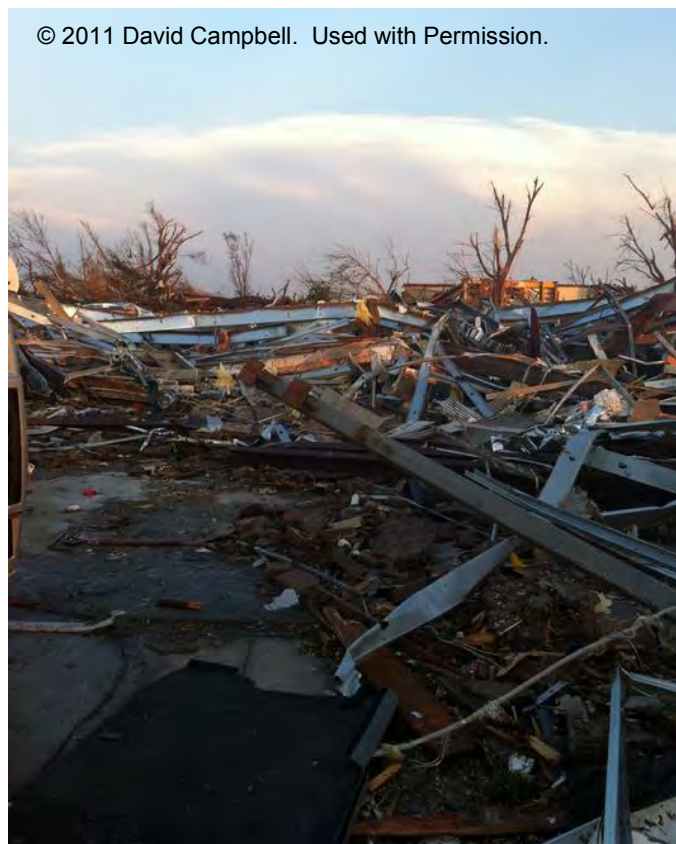

Figure 4-9. The AT&T store following the May 22, 2011, Joplin tornado.

The store was exposed to an estimated maximum wind speed of approximately 160 mph \pm 20 mph during the storm. One employee remembered the bathroom door coming off the hinges, slamming him in the back, and sending him flying into a brick wall (CWA 2011). Another employee recalled feeling for a moment like he was flying and then the sensation of being crushed, before he was knocked unconscious. When the storm was over, building materials and other debris had pinned some of the employees, so much so that they were unable to move. Those who could free themselves went for help, and those who remained realized that there was one death among them (i.e., an employee). One employee stated that the deceased was pinned down by a metal door (Skinner 2011). The severity of injuries to survivors at the AT&T store is unknown.

The AT&T store was not the only commercial structure in which patrons and employees took refuge in locations toward the back of the store. Two blocks south of the AT&T store, patrons and employees took refuge in the back of a yogurt shop called Cherry Berry (located at 1900 Range Line Road in Joplin), which was a wood-frame building. An employee was interviewed about her experiences inside the store before and during the May 22, 2011, Joplin tornado. She and the other occupants were first made aware of the weather by the sound of the tornado sirens. After thinking about what the sirens meant to her, she provided the following explanation:

We're in kind of a valley, and most tornadoes will hit surrounding areas but it's a rare occurrence where one will ever hit Joplin. And they sound the tornado sirens all the time. Every spring we hear 'em go off at some storm, and people around this area go on their front porch and sit there and wait for something to come. I mean nobody really takes shelter. And so the tornado sirens didn't faze anybody. Nobody in the building was worried. (NIST Interview 123)

It was not until another employee received a phone call informing him or her that a tornado was located at 17th Street and Michigan Avenue in Joplin that people started to take notice. At this point, the manager at Cherry Berry decided to get everyone into the bathrooms located in the back of the yogurt shop. They placed as many people in the bathrooms as possible, and others (three employees) were sent to the back offices. Before she took refuge in the offices, the employee who spoke to NIST recalled moving to the front of the store to get a view of the weather. She recalled "seeing debris flying all around us and I remember the windows shaking, and then I saw a car go flying in the air" (NIST Interview 123), and that prompted all three employees to run to the back offices. The three employees and one patron rode out the storm in a back office.

They knew that the tornado was upon them when they felt their ears popping. The interviewee recalled the destruction created by the tornado:

We were on the north wall, and I was sitting against the door which was on the east wall. So I'm sitting northeast in there trying to hold the door shut, and then all of a sudden the whole building starts vibrating in that door. And we have that 2,000-pound—we have eight, 2,000-pound yogurt mixers in there, and so all of a sudden the door is just bashing me and him up against that wall, 'cause I can't keep it shut all by myself. And [fellow employee] finally scoots over towards me and he puts—he shields his—he shields me with his body, basically. He tucked my head underneath his armpit, kind of had me in a choke hold, and he said for

me to hold on as tight as I can. And then the south wall ended up getting sucked out, and so there was a pretty good chunk of the south wall that went missing, and so I don't remember as much as the sound as I do that door banging the most and then when the eye of it came I thought it was done. And I don't remember dialing my phone, but apparently I tried to call like 10 people in the eye of it and I ended up connecting to my mom, and I told her the wall's been sucked out, we're buried under rubble, I think it's done, and then I remember saying it's not done, it's coming again. And I remember her saying on the phone oh my God I'm coming to get you. And I remember me yelling, do not come up here, you will get killed, do not come up here. And then I hung up the phone and we braced for the end of it. We braced for the other part of the tornado to come through and about at that time we could feel the suction of the tornado, 'cause we were missing a pretty good chunk of the wall and all of a sudden the ceiling came down on us. A huge chunk of ceiling, heavy, and it landed right on top of our heads, and that's probably the only thing that kept us from getting completely sucked out. And then finally after it stopped for the most part, we sat there for a second just to make sure. (NIST Interview 123)

She recalled having concrete embedded in her shirt and that her scalp was bloodied due to the debris that had pummeled their bodies. There were no deaths inside the Cherry Berry, which was exposed to an estimated maximum wind speed of approximately 170 mph \pm 20 mph. The employee whom NIST interviewed did not have to seek medical attention, but recalled scrapes and bruises, and being completely covered in fiberglass that was painful to scrub away.

4.4.7 Home Depot

The Home Depot store located at 3110 East 20th Street in Joplin was another location within the tornado's damage path where people lost their lives on May 22, 2011 (see Fig. 4-10). It was a one-story, box-type system building, and further information on its construction can be found in Chapter 3. Information from death certificates, corroborated by information from other sources (see Sec. 4.2), indicated that eight individuals died at this Home Depot during the storm. However, a NIST interview with one of the store managers located in the store that evening found that seven individuals, including one Home Depot associate, died inside the store that evening. NIST received information from Home Depot's corporate offices about the store's tornado emergency procedures. The CDC EPI-Aid Study did not include any individuals injured inside the Home Depot by the tornado. All information reflected here on the circumstances encountered inside the Home Depot before the tornado hit was obtained from media accounts (Younker 2011b) and NIST interviews.

Prior to May 22, 2011, the Home Depot had standard operating procedures for tornado emergencies (NIST Interview 149). The procedures stated that once managers became aware of an imminent tornado emergency, they were to monitor broadcasts for information about the developing storm. If an official warning was issued for an area in which a Home Depot store was located, management would notify customers and associates via the building-wide public address system to remain calm and move into a nearby aisle. Associates would then direct customers to the appropriate refuge areas in the store. Depending upon the particular Home Depot location, refuge locations could include any of the following: the restrooms, break room, training room, or office areas located in the rear of the store. These locations

were chosen as refuge areas because they were separated from the selling floor; i.e., these areas contained no products or windows, and thus were not subject to threats from projectiles, and were located near an emergency exit. Once inside the refuge area(s), people were to be told to cover their heads and crouch down until the storm threat ended.



Figure 4–10. A view of the Home Depot building that collapsed in the May 22, 2011, Joplin tornado.

Interviews with the acting store manager on duty during the May 22, 2011, Joplin tornado provided information on how individuals in this Home Depot received word of the storm (NIST Interview 152). The managers had been monitoring the weather since earlier in the day via the Internet (i.e., the computers at the service desk), weather applications on smart phones, regular radios inside the store, and the store's NWR. When the first sirens sounded, which the store manager could hear from inside the store, department managers made announcements to customers via the public address system. These announcements were to the effect that store occupants should be aware that bad weather was approaching, store management was not yet sure how serious the situation was, but to remain alert for further information. From this point, the store manager continually monitored all of the previously identified channels of information. Additionally, he called family and other managers and assistant managers (outside the store) to see if anyone had access to a live television feed on the weather. The store manager also monitored the weather by watching the sky outside of the Home Depot. When he saw power lines flashing off toward the west side of town, he decided that it was time to warn customers and staff to take shelter. This was because, to him, the power flashes (i.e., seeing blue and green flashes in the sky, rather than the yellow or white flashes typically made by lighting) meant that there were power lines going down and damage was occurring somewhere. At that point, the store manager made a store-wide public address announcement stating that store associates should direct all customers to the training room immediately and that this was not a drill. Shortly after that, according to the manager, the second sirens sounded. Approximately 30 people had gathered in the training room for only a short time (no specific amount of time was reported) when the tornado struck the building (NIST Interview 149).

The Home Depot was exposed to an estimated maximum wind speed of approximately 170 mph \pm 20 mph. The concrete wall at the back of the store collapsed outward (i.e., away from the people located in the training room) under the force of the tornado's winds (see Chapter 3 for additional information about the damage to the building). The steel stud and plywood wall of the training room, which separated the room from the rest of the store, toppled over into the training room and rested on top of one of the tables inside the room, leaving a 3 ft "crawl space" available to the occupants. People who had taken refuge inside the training room were able to crawl out of the wreckage nearly unharmed (NIST Interview 152).

Seven or eight individuals (depending upon the source) located inside the store that evening did not survive the storm. According to the store manager's interview with NIST, these individuals had entered the store through the lumber entrance minutes to seconds before the storm hit the Home Depot. After entering, these individuals turned left and were walking parallel to the store's front wall, when a section of the wall slab fell inward (into the store) and landed on top of them (NIST Interview 152). One of the individuals who died in the Home Depot that evening was a Home Depot associate (Turner Report blog 2011) who had gone to the lumber entrance to unlock the door and let in two groups of people as the storm was approaching. The death certificates of the eight individuals attributed (by death certificates) to the Home Depot noted that they died the night of May 22, 2011, from blunt-force trauma to the body.

4.4.8 Pizza Hut

People were dining and working in the Pizza Hut located at 1901 South Range Line Road in Joplin during the afternoon of May 22, 2011. NIST conducted two interviews with employees of the Pizza Hut who were there during the storm and obtained additional information from an NWS interview with one of the two restaurant shift leaders on duty that day (NWS User/Business Interview 7) and media accounts (KSHB 2011; NBCActionNews 2011; Younker 2011c). Around 5 p.m., the shift leader noticed that the sky was getting dark and felt that something was different with the weather. Knowing that there were thunderstorm warnings out for the area, but unaware of the tornado watch, he called home only to find out that there was a tornado around the Galena area (approximately 7 miles west of Joplin, city center to city center). This information and the fact that delivery drivers were calling in regarding reports of hail storms in the area, persuaded the shift leader to wait inside the restaurant until the weather improved (note: his shift ended at 5 p.m.).

Around 5:11 p.m., he heard the sirens first sound. At that point, he and other staff instructed customers to leave the store or take shelter inside the building, which he was required to secure (according to store policy). Three customers left the restaurant and approximately 14 customers remained (NIST Interview 150). He also instructed staff to turn on the radio, which prompted others to check weather radar via their smart phones. According to interviewees, the store protocol advises patrons of the Pizza Hut to take shelter inside the cooler, which was insulated in foam and surrounded in sheet metal (NIST Interviews 150, 151; NWS User/Business Interview 7).

Around 5:38 p.m., the occupants heard the sirens sound a second time. Some of the patrons and employees discussed whether this was meant to signify an "all-clear message." The interviewed shift leader did not believe the second sirens signified an all-clear message because the radio had not indicated that the weather had cleared. Therefore, he advised them to remain sheltered in the building. Shortly after, one of his staff noted that a tornado was located on Main Street, based upon radar information that he or she had accessed via a smart phone (NWS User/Business Interview 7).

After the second sounding of the sirens, management advised staff and patrons to take shelter or remain sheltered inside the cooler. Some individuals waited until they saw the storm approaching before entering the cooler. An employee grabbed the bungee cord that is normally used to pull the cooler door shut from the inside when employees enter or exit the cooler, wrapped it around his wrist, and tied it to a rack (NIST Interviews 150, 151). As the tornado ripped through the wood-frame restaurant, with an estimated maximum wind speed of approximately 170 mph \pm 20 mph, the cooler door slipped open. The scene was described by people inside the cooler in the following way: “And then when everything blew away, he was gone, the door was gone, everything” (KSHB 2011).

The tornado killed five people at the Pizza Hut, including two employees, one of whom had tried to hold the cooler door closed with the bungee cord. The two employees were thrown from the cooler by the storm, one as far as 400 ft away to a nearby Aldi’s store, and the other into the Sonic store next door. The other six employees survived, but sustained injuries from being thrown as well. There were three confirmed fatalities among the customers. All five of the decedents died from multiple blunt-force trauma to the body inflicted by the tornado, according to the death certificates.

A cooler was also used as a refuge from the tornado at the Dillon’s grocery store located at 1402 East 20th Street in Joplin, which was in the center of the tornado’s path and one block east of Harmony Heights Baptist Church. NIST obtained information from store management and from two patrons present during the storm (NIST Interviews 132, 147). A manager at the Dillon’s store had been monitoring the weather conditions ever since the sirens first sounded. Equipped with information from radar (via the Weather Underground website) and his NWR, the manager made the final decision to shelter his employees and customers when the sirens sounded a second time and the weather radio noted a tornado warning. Additional confirmation was made when he noticed how windy it had become outside. He told everyone in the store, via intercom, that “we were under a tornado warning. And that if everybody would please go to my produce cooler” (NIST Interview 132). The cooler was made of foam walls with aluminum sheathing over the side. As the front windows of his store blew out, he was still shoving people back into the cooler, which eventually housed close to 35 people. He described what happened next:

I pulled the two doors shut which were, they were just flimsy little bi-fold aluminum doors. The wind hit, and just literally ripped the doors out of my hands. And that’s when it really got nasty. I’m trying to hold the doors shut. It literally picked me up. It was pulling me out of the cooler. When two of the girls inside of the cooler grabbed hold of me and held onto me. And then it probably wasn’t, I’m guessing, 30 seconds, maybe a minute, that it took for everything to [pause]—for the tornado to be over. It seemed like an hour, you know, because I sat there and I watched my store just literally disintegrate. We’re inside this little bitty cooler that’s probably 12–, maybe 15–feet wide, by 30–feet long. People are screaming. People are praying. Then it was over, you know. (NIST Interview 132)

The Dillon’s store was a box-type construction made of CMU perimeter walls and open-joint steel roof trusses. The store was exposed to an estimated maximum wind speed of approximately 170 mph \pm 20 mph. See Fig. 4–11 for damage to the Dillon’s grocery inflicted by the May 22, 2011, Joplin tornado. The tornado caused injuries among building occupants, including cuts, bruises, and scratches; however, none of these injuries was life-threatening.

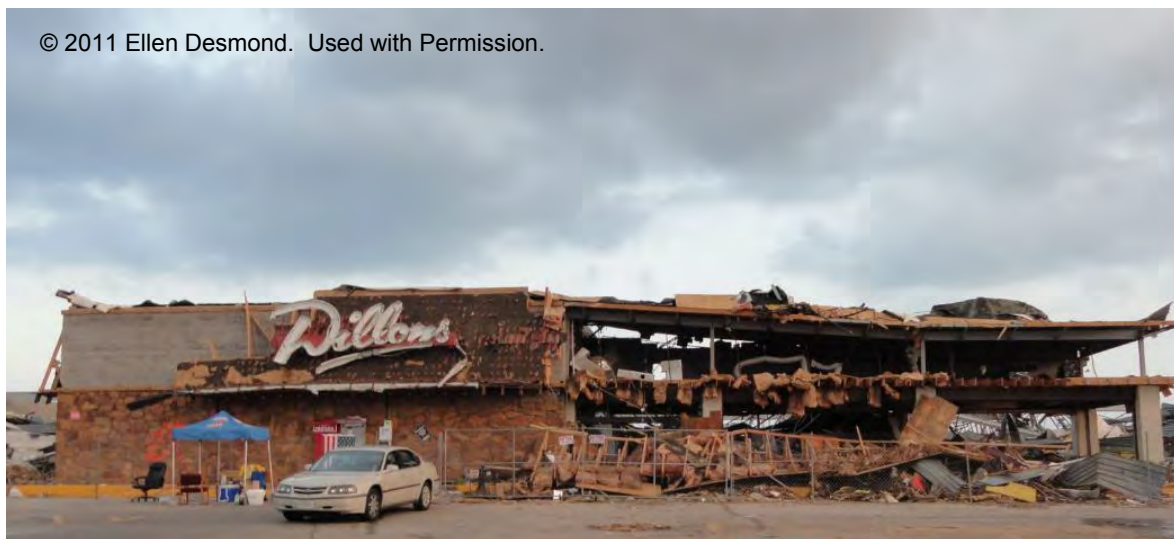

Figure 4–11. Damage to Dillon’s grocery inflicted by the May 22, 2011, Joplin tornado.

The cooler was located in a corner of the store, against the exterior wall on the western side of the building. After the tornado blew through the building, the cooler remained nominally intact. The cooler doors had popped off and a steel beam had fallen on top of the cooler, which crushed into the back part of it. However, when the tornado was over, the cooler remained standing.

4.4.9 Walmart Store #59

Walmart Store #59, located at 1501 South Range Line Road in Joplin, was another place within the tornado’s damage path where people lost their lives on May 22, 2011. Similar to the Home Depot, this Walmart store was a one-story, box-type system building; however, differences in the two buildings’ construction are noted in Chapter 3. NIST obtained narratives from three survivors who were in the Walmart store at the time of the storm, in addition to information from Walmart’s Emergency Operations Center (EOC) in Bentonville, Arkansas, regarding tornado procedures for the stores (NWS 2011).

According to the Walmart EOC, when a tornado warning is issued for an area in which a Walmart store is located, a communications company contracted by Walmart (named Everbridge) calls and sends e-mail messages to the store’s managers to provide them with this warning information. The company bases its information on polygon warnings from the NWS. The store protocol for a tornado warning is known as Code Black, which is announced via the store public address system. When Code Black is activated, all customers and associates should proceed to the back of the building, in order to get everyone away from the front windows and doors as well as away from the over 200 skylights that are part of most Walmart buildings. Information provided by the Walmart EOC also states that the back of the store has more “real walls and restrooms.” It is up to the store manager’s discretion as to when (and whether) to cease store operations and instruct customers and associates to take shelter (NWS 2011).

The manager at Store #59 had reviewed Walmart's weather emergency procedures following the tornado outbreak that occurred in the Southeast United States in April, 2011. Also, on March 1 of every year, the Walmart EOC sends out preparedness information to all stores.

On May 22, 2011, a telephone call and e-mail were received by the manager at Store #59 within 60 seconds after the NWS issued the tornado warning (however, it is not clear whether this was the warning related to Tornado Warning Polygon 30 or 31). At the time, there were approximately 200 customers and associates inside the store (NWS 2011). An associate recalled that, shortly after the sirens sounded in Joplin (the first time), her manager walked around the store telling her and other associates that "everybody needs to leave and go back to Site to Store" (NIST Interview 99). Site to Store was an area in the back of the store where customers picked up merchandise ordered online. People slowly began moving to the back of the store as the managers continued to tell everyone, with urgency, to keep going to the Site-to-Store area at the back of the store (NIST Interview 99). Employees who had already gone to the Site-to-Store area were then told that if they left the area, they would be fired. Management said, according to an associate, "'Do not leave this area. If you leave this area, you're no longer Walmart's responsibility.' And so basically they were letting people know, 'You must stay here. This is the safest area. You've got to stay here'" (NIST Interview 99).

As this associate huddled with approximately 50 to 60 other people in the Site-to-Store area, she heard glass windows breaking and saw the two doors (fire escape doors) located nearby suddenly blow straight open. At that moment, the ceiling tiles lifted and the lights went out

and we all jumped off the counter, landing all over each other . . . And we were just kinda this mass of arms and legs and bodies, and at that point, it was—you know, people were screaming and crying and cursing and praying, and I was praying . . . The girders broke all around us; they were like crashing down. Nobody really knew what was happening. It was just this horrible roar. I really didn't know how long it lasted . . . And when it was over, there was a girder on my back, but it was resting—when I say "on my back," it was touching my back, but it wasn't laying on me. The girder had actually landed on one of the older men that could not get off the counter in time up above me, and it was at about a, oh, I wanna say a 45-degree angle. It was resting on the cabinet, and then it went down to a point inside the cabinets. It actually broke—well, the cabinets were pretty much destroyed on that end, but the weight of the girder, it crashed down. But that cabinet where that man was saved all of our lives in there, because it made like this—most of the girders, most of the ceiling girders, when they landed, they just made a cap and landed, mainly right across the cabinets. It made a little pocket inside of those cabinets; a little D-shaped pocket, where we had probably 50, maybe 60 people inside of there. (NIST Interview 99)

Some injuries, although no exact number could be determined, did occur inside that "refuge" location. However, the associate was not aware of any fatalities that occurred within this Site-to-Store area of the store.

A father and daughter took refuge in another location inside the Walmart. They were told by a manager to go to the back of the store. When people only leisurely took heed, the manager tried again, in a "pretty

high tone of voice or something, by saying, ‘People, this is for your safety. Please move to the back of the store.’ And then I guess it dawned on people—they started moving a little faster. And then he said, ‘Calm down. Take your time, just be safe—get back there’” (NIST Interview 81). The father and daughter made it as far back as the Electronics section of the store (directly in front of the Site-to-Store area) and waited there, when all of a sudden the lights flickered. The father remembers the ceiling tiles bouncing up and down, and when he heard the sound of the tornado, which sounded to them like a loud train, he told his daughter to get down. They both got down on their hands and knees and waited for the tornado to pass. When it was clear enough for them to raise their heads, the father saw what was an internal building column before the storm, now laying beside them. He also recalled that two people, located right beside his daughter and him, lost their lives that evening (NIST Interview 81).

As discussed in Chapter 3, the uncollapsed north half of the building experienced a lower estimated maximum wind speed of $120 \text{ mph} \pm 20 \text{ mph}$ (EF-2 speeds, from a northerly direction) and the collapsed south half experienced a higher estimated maximum wind speed of $165 \text{ mph} \pm 20 \text{ mph}$ (EF-3 to EF-4 speeds, from a west-northerly wind direction) (see Fig. 4-12). A total of three people lost their lives that day in the Walmart. It is uncertain exactly where, inside the store, the fatally injured were located. However, information from the Walmart EOC notes that the fatalities were reportedly the persons closest to the center of the store. All three decedents died due to blunt-force trauma to the body, according to the death certificates. No information could be found on how many did not take shelter in the Site-to-Store refuge area or on the number of people injured at the store.



Figure 4-12. Aerial photo of the tornado-damaged Walmart Store #59, showing the collapsed south half and uncollapsed north half of the building.

4.4.10 Single-Family Homes and Apartment Complexes

The May 22, 2011, Joplin tornado damaged 7,411 residential buildings, including single-family homes¹³⁵ and at least five apartment complexes, along its path through the city. The five apartment complexes identified as having been within the damage path were the following: Connecticut Point apartments (2034 Connecticut Avenue), Hampshire Terrace apartments (2020 Hampshire Terrace), Somerset apartments (2001 Connecticut Avenue), Dock apartments (2123 Rhode Island Avenue), and Plaza apartments (1715 South Rex Avenue).

Around 5 p.m. on Sunday, May 22, 2011, there were many people in the Joplin area who were located at home or at someone else's home. NIST spoke to 109 individuals located at home when the storm hit, 99 of whom were already located at home when they received warnings (or emergency information) after 5:09 p.m., and 10 of whom were located elsewhere and then returned home after receiving emergency information. Figure 4-13 shows the locations of 104 of the 109 at-home survivors with whom NIST spoke directly. Each of these 104 locations (marking either a single-family home or an apartment) is indicated by a blue dot in Fig. 4-13. (Five of the 109 interviewees were not located on the map because their exact addresses were not provided to NIST.) Figure 4-13 also shows the distribution of the interviewees relative to the tornado's estimated center track. It can be seen that some interviewees were located outside the damage path; they were interviewed in order to provide a more comprehensive story of public response to the emergency communication system (some of these individuals are also not plotted on Fig. 4-13). NIST also collected information on 34 individuals who were injured at home (using the CDC dataset) as well as on the 74 individuals who died in single-family homes or multi-family apartment buildings in Joplin.

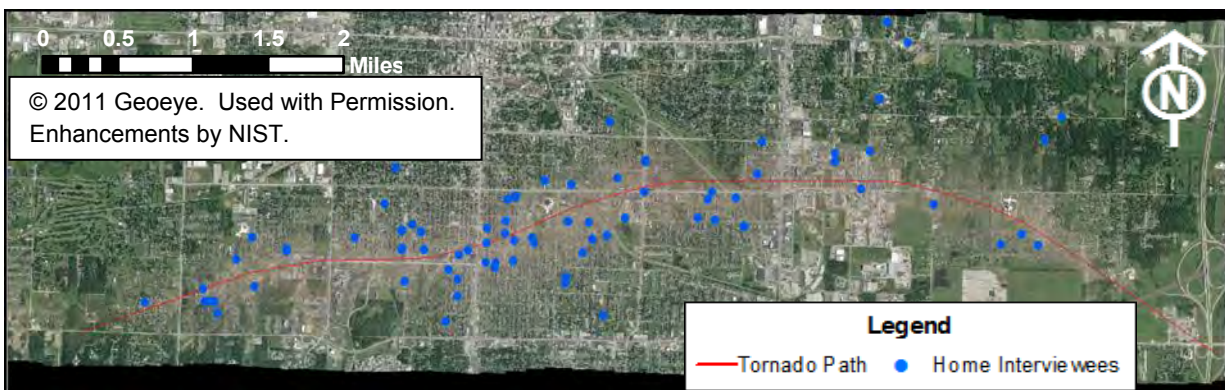

Figure 4-13. Geographic locations of 104 of the 109 NIST interviewees who were located at home when the tornado hit Joplin. The red line indicates the estimated center track of the tornado.

Very little information could be gleaned about how the deceased received information prior to the storm, except where NIST was able to speak with survivors who either spoke with these individuals or were located within the same home as they (the latter occurred in two single-family homes in this sample).

¹³⁵The term single-family home is meant to identify all types of detached residential structures, which are distinguished here from multi-family apartment complexes or nursing homes. Single-family homes in this sample can include semi-detached homes in which two single-family homes share one "party" wall.

CDC's dataset of the injured did not contain information on tornado awareness. Therefore, general information on pre-tornado emergency communication within individual homes and apartments was gathered from the survivors who spoke directly with NIST, as well as from media accounts. Information on refuge locations (within homes) has been obtained for survivors (both NIST interviewees and injured persons from the CDC sample) and for those killed in homes and apartments (unless the deceased individual was home alone at the time of the tornado strike, making it almost impossible to obtain information on their refuge location).

As mentioned earlier, the majority of the interviewees (99 of 109) were located at home at approximately 5 p.m., when emergency information was provided to them regarding the storm, and they remained at home throughout the duration of the tornado event. However, it should be noted that only two of the interviewees mentioned that they were at home that Sunday specifically because they were fearful about the possibility of inclement weather. One of these two individuals, who was supposed to attend Joplin High School's graduation ceremony at MSSU, relayed her reasons for remaining at home all day on Sunday:

And I actually knew on Friday that we were supposed to have severe weather on Sunday. And I was actually supposed to go to the high school graduation that afternoon. My daughter's oldest stepson was graduating, and I had a ticket to go . . . and I said if anyone wants my ticket, they can have it, because there's supposed to be severe weather on Sunday and I'm not going anywhere. I was at home and it was a beautiful morning, but I just kept watching the weather because—I watched it on Saturday also, and they just kept talking about we were supposed to have severe weather on Sunday, with the possibility of tornadoes. And so I was just on top of it. (NIST Interview 110)

All others were at home because that was their normal Sunday routine or what they had decided to do that Sunday, regardless of the weather. That is not to say, however, that these individuals did not monitor the weather while they were at home. While some were sleeping, getting ready to go somewhere, or watching movies, for example, and not monitoring the weather, others had turned to televisions, radios, or the Internet for weather updates, and even had these playing in the background while they engaged in other activities.

Those interviewees already tuned in to news or weather stations received word of the tornado warning issued at 5:09 p.m. for Tornado Warning Polygon 30, the storm cell affecting northeast Joplin. Additionally, they and almost all others located at home heard the 5:11 p.m. outdoor sirens, even from inside their homes. An interviewee who lived in a heavily wooded area in Joplin, and an interviewee who was deaf, did not hear the sirens sounding. The same was true for the three interviewees who were sleeping when the sirens sounded and the warnings were issued. These individuals relied on telephone calls or text messages from other individuals to alert them of the warnings and impending storm. Only one interviewee was notified of the impending storm via a weather radio, even though many more mentioned having an NWR in the house. These latter interviewees admitted that their weather radio device was either not turned on, did not receive the signal, or did not go off (even though it should have) when storm warnings were assigned to their area. None of the interviewees mentioned receiving initial weather information via automated text alerts.

One response, implemented by only a few of those receiving this initial warning information, was to take refuge inside the home immediately. Only 8 of the 99 individuals who were already at home sought shelter immediately within their homes. Within this group, there were three individuals (3 of 99) who had already been highly concerned about the possibility of tornadoes on May 22, 2011 and had been monitoring weather information for most of the afternoon via television or weather-related websites (e.g., Intellicast or SkyWatch (local news)). They had begun and continued their search for information prior to the sirens sounding. The other five interviewees who took refuge immediately (5 of 99) after hearing the sirens explained that they always take such precautions: “I’m not somebody who stands on the porch to wait and see if I can see it when it comes. No, that’s not me.” According to this interviewee, the sound of a siren means that a tornado is possible, and it could happen anywhere, any minute (NIST Interview 62).

An action that was more commonly taken after hearing the outdoor sirens was to search for additional information to confirm the existence of a serious weather event. One option taken was to look at the conditions outside for confirmation. An interviewee who was watching a previously recorded television show noted that he

used to live in Oklahoma, Oklahoma City specifically, so a lot of times when the sirens go off, my first thing is to look out the closest window that has the shades up. If I don’t see stuff flying in the air I know I’m not right in it. (NIST Interview 30)

Another interviewee noted that “most of the time, you may glance outside and you may just wait for them [the sirens] to stop” (NIST Interview 85). For others, answers were sought by tuning into televisions or radios, especially to stations that regularly provide weather information. A response that was even more common than that was soliciting information and advice from family and friends about what was going on and what they should do about it.

Unfortunately, very little information or cues were available at 5:11 p.m. for interviewees to use to confirm a threat. Interviewees noted that the weather looked “fine” outside (NIST Interview 92), looked like a storm was going to pass to the north (NIST Interview 11), or did not look threatening—just some light rain, thunder, and lightning (NIST Interview 31). A Joplin native who was expecting to see a tornado recalled that

the neighbors were all out, looking around at the weather when this first siren went off, and they were just like me, wondering what’s going on. Why is the siren going off when there’s really nothing in the sky that looks like a tornado? (NIST Interview 42)

Individuals who tuned into weather reports received news about a storm traveling to the north of Joplin, heading to Webb City, Missouri, or Carl Junction, Missouri (NIST Interview 43). A Joplin native remembered that

the announcer and the weatherman that came on the TV seemed to say the track was, you know, mainly north of town. It wasn’t going to be a bother for where I was at towards the south part of town. So, I continued to sit there on the front porch and enjoy the cool air that was, you know, for the day. (NIST Interview 58)

According to another interviewee, the storm “looked like it was even way up north, like Pittsburg. I said, ‘That’s not gonna come down and get us.’ So I just kind of ate my food there and was watching that” (NIST Interview 94). The storm that weather forecasters were tracking at that point in time was a storm to the north of Joplin (Tornado Warning Polygon 30). After hearing this information and based upon the perceived tendency for storms to track to the northeast only, interviewees concluded that they were not at risk at the time of the initial siren/warnings.

Conditions appeared similar to the 10 individuals NIST interviewed who were not at home when the initial warning and information about tornadoes were provided, but reached home before the tornado hit. These individuals were leaving Joplin High School’s graduation ceremonies, eating an early dinner at local restaurants, running errands at Joplin businesses, or attending worship services at around 5 p.m. that evening. Outdoor sirens were the primary way that these individuals were made aware of impending storms, after which they either looked to the sky, to televisions (i.e., in restaurants or shops), or to radios (in vehicles) for further information. None was afraid that an imminent tornado would hit them (or their house); they continued toward home because they were ready to get home anyway (regardless of the storm) or because they wanted to protect something (i.e., pets or their car) or someone (their children) in case a storm did occur. For example, a couple was located at a Joplin restaurant when they heard the sirens sounding:

They had a TV monitor and a radio in the restaurant, and so we listened to that for a little bit. And at that particular time, they were talking about everything going to the north of us. So we went ahead and paid and decided to drive on home. (NIST Interview 44)

Another couple was at the Joplin High School graduation when the sirens sounded. The husband recalled: “Look at the clouds. Look the sirens are going off. I said, ‘You know what? They do that a lot,’” and the couple continued home (NIST Interview 22b). Only one interviewee, who was heading in a northerly direction, driving to church, was concerned that he was actually driving into the storm. Therefore, he turned his car around and went back home (NIST Interview 101). Overall, individuals believed that it was safe to drive at that time, even after the sirens had sounded, since they did not see anything too threatening in the sky and/or they were aware that a storm was passing to the north, and they were traveling to the south of it.

However, as those in vehicles continued home and others at home continued to monitor the weather, not much in the way of additional information was provided (either that the danger had passed (to the north) or that there was new and imminent danger from the west) before the second siren sounding. One interviewee decided to drive home from church with his children when the sirens sounded again because he was concerned about the level of safety provided by a “pre-fab building” (NIST Interview 54). He continued to monitor the storm via his vehicle’s radio: “I was listening to KZRG at the time. They said they didn’t indicate anything was on the ground at the time, but they issued this warning in advance because there was an area of circulation right about central—right about the State line—close between the State line and Central City Road. And so I thought, ‘Okay, I got time.’” (NIST Interview 54). Others at home recalled television statements about radar indicating that the storm was still to the north (NIST Interviews 11, 33, 102), that it looked like the storm was going to miss us since it was going around Galena (NIST Interview 23), that the storm had turned (NIST Interview 36), that the tornado hit a town in Kansas (NIST Interview 58), that there was a tornado on the ground in Galena (NIST Interview 85), and

that there were severe thunderstorms to the west (NIST Interview 84). A few mentioned not seeing any warnings on television at all (e.g., NIST Interviews 118, 133).

Even as late as 5:36 p.m., 2 min before the tornado entered Joplin city limits, television and radio stations were not confirming the presence of a large-scale tornado heading for Joplin. For example, KOAM-TV (Channel 7) and KFJX-TV (Fox 14) broadcast the following weather information between 5:36:48 p.m. and 5:38:19 p.m.¹³⁶:

We are looking . . . oh . . . very close to downtown in Joplin, we have had confirmed funnels from westward from Galena to Riverton as it passes off towards the east at about 20, so it's really working right through downtown and also the western side, so right in the heart of Joplin is where we are seeing the rotation and the confirmed reports of at least funnel clouds that can drop a tornado at any time and it's going to continue to work off toward the east so eventually the east side of Joplin, you need to definitely watch this cell very closely, Dusquesne will be right in the track of this cell and continuing eventually to the 249 loop and then out near I-44. I think the heart or at least the rotation part of the cell will stay south of Carthage but the hail core's going to really affect areas from Webb City to Oronogo, where you can pick up anywhere from golf-ball- upwards to baseball-sized hail. So again, right now we are watching this tornado warning, which is right through the Joplin metro, the heart, right around downtown moving east, and there's numerous little areas of rotation, so I'm gonna go ahead and say from Duenweg back to the western side, you could see funnel clouds or drop a tornado so this whole area needs to take shelter as this could obviously be a very dangerous situation. Plus, on top of that the very gusty winds and the large hail. Of course, keep it here, I'm going to keep you updated . . . for now, back to programming.

What prompted a majority of individuals located in single-family homes and apartments to take internal shelter from the storm, if they took shelter at all, was actually seeing, hearing, and feeling the effects of the tornado itself. One of the few interviewees tuned into an NWR recalled listening to the warning for Tornado Polygon 31 that put Joplin directly in the path of a tornado (NIST Interview 31). After receiving that information

we didn't stray too far from the front porch, and when we initially got to the front porch the second time the sun was out, although you could see off to the west and slightly to the north of where we lived that it was pretty dark and it was thundering and lightning pretty good; and then we had a little bit of hail. We did not seek shelter in the basement of our home until the trees in our neighbor's yard came down, and we heard the sound, which I'll never forget the sound—never, never, never—you never forget the sound. (NIST Interview 31)

¹³⁶ This text is a transcription from the television broadcast disseminated by KOAM-TV (Channel 7) and KFJX-TV (Fox 14) between 5:36:48 p.m. and 5:38:19 p.m. on May 22, 2011. The video was provided to NIST by KOAM-TV.

Some also credited the sound of the second sirens as a prompting mechanism for them, but for most interviewees, the second round of sirens sounded at the same time that they witnessed the tornado approaching. Interviewees painted a picture of the danger they saw, felt, and heard between 5:38 p.m., when the tornado entered Joplin, and 5:50 p.m. (approximately), when the tornado left the city. A young couple and their kids were playing in the house that day, when the father saw what could only be described as a black, thick wall of debris:

We heard the tornado siren come on. So [my child] had kinda gotten away from my wife and was running around, kind of—he was trying to remain just being a kid. Then it was there. It was boom! You could hear it. It was now—the grinding noise in the background was front and center. You couldn't hear anything else. The sirens were almost drowned out, and it was coming upon us. I was able to look out our door, and I was able to see. It was just—it was moving fast . . . a wall of debris and I saw pieces of houses 100 foot off the ground. (NIST Interview 5)

Another Joplin resident described it as a huge dark cloud, and “it was an animal like coming toward me, toward my door” (NIST Interview 14). People mentioned that the trees were swirling, swaying, and even laying down in a manner that they had never seen before (NIST Interview 111), and cars were lifted off of the ground (NIST Interview 22b). The visual cues were accompanied by the sound of the tornado, described most often as like that of a freight train or continual thunder. Also, interviewees mentioned feeling their ears popping as the tornado grew near.

Interviewees also recalled multiple television channels that were broadcasting a visual shot of the tornado via their camera (i.e., Nexstar Broadcasting (parent company for KSNF-TV (NBC Channel 16) and KODE-TV (ABC Channel 12), KOAM-TV (Channel 7), and KFJX-TV (Fox 14)), allowing viewers to see firsthand the damage left in its path. A woman at home at the time heard the second siren and thought that it was odd to hear a second one sound:

So I clicked on and I was watching a local TV station that has a tower cam that was facing the west. And they were watching some big black cloud that looked like it was coming across the State line. And they said they couldn't tell if it was just the thunderstorm moving in or if there was something else. And then they started seeing—it wasn't lightning. They were hitting transformers and it was like power lights, you know, like an explosion. I guess when it hit this transformer. (NIST Interview 133)

Interviewees remembered the newscasters' voices on a Nexstar channel sounding more alarmed than usual (NIST Interview 129). It was at this time that a female anchor decided to give instructions to the listening audience. Some interviewees even credited her specifically for their decision to take cover, mainly due to the things she said and how she said them:

She was like, “Oh, my God.” She said, “Everybody, take cover. Take cover now.” She said, “It's coming right at us.” She said, “I mean now” in a very hysterical voice, and my husband and I looked at the TV at the same time, and we could see on the weather cam the wedge tornado, and she was just yelling, you know, “It's coming right at us.” (NIST Interview 84)

Even when the picture cut out, she pleaded with her listening audience, “If you can still hear my voice you need to take cover now.” And, at that moment, the power went off (NIST Interview 129).

Interviewees began realizing that there was something really wrong, and that they needed to find shelter from the storm, if possible. The options available in single-family homes throughout the Joplin area were primarily internal (centrally located) bathrooms, closets, laundry rooms, or hallways. Basements were scarce, due to the consistency of the soil and the difficulty this soil posed for constructing basements in the Joplin area (as noted in Sec. 4.3.3), and there were only a few known locations where individuals had in-home storm or tornado shelters. Interviewees in apartment buildings took refuge in internal areas of their first-, second-, or third-floor apartments, or on the ground floors of their complexes (and in one known case, under a public staircase (NIST Interview 41)).

Inside their shelters, individuals used pillows, couch cushions, blankets, and in a few cases,¹³⁷ mattresses to keep debris from injuring themselves and their loved ones. Inside bathrooms, as many family members as possible took refuge in the tub, throwing pillows and blankets over the top for protection (NIST Interviews 23, 41, 114). Men sheltered women, couples held each other, parents covered and protected their children, whatever it took to keep their families and friends safe from the storm (NIST Interviews 27, 40, 102).

Interviewees in single-family homes rarely took refuge in their crawl spaces. Only one interviewee noted using his or her space for protection before the storm hit.¹³⁸ Overwhelmingly, interviewees did not feel like they had enough time to access the crawl space. Additionally, interviewees admitted that the spaces were difficult to get into, and since many decided to take protection as the tornado was bearing down upon them, they considered the crawl space impractical (for example, Interviews 5, 29, 88, 90, 114). A Joplin native described this predicament in the following way:

By the time I get to the other end of the house, go outside, pull off the roof, get underneath the house, go back inside, grab two dogs, take them back out there, put them under the house, go back inside and grab the last dog, I’m dead. We’re all going to die. (NIST Interview 88)

Others were concerned that the crawl space was not large enough to provide access to them, their family members, and/or their pets (NIST Interview 101) or would prove difficult to get out of (due to pre-existing injuries) once the storm was over (NIST Interview 36). Finally, the conditions in crawl spaces were not always attractive, even in the face of an impending storm (NIST Interviews 32, 85). A woman reflected on the crawl space option, saying

we did have a crawl space, but we didn’t have—we thought about going under there. One, my daughter didn’t wanna go under the house. She

¹³⁷ In one case, three men died and one man was severely injured after they took refuge under a mattress in the utility room of a single-family home. In two cases, survivors took mattresses into internal refuge areas within the home (NIST Interviews 52, 67). In one case, a family took refuge under a mattress in their bedroom, with the husband laying on top of the mattress (NIST Interview 77); and in another case, a survivor got in between his mattress and box spring to take shelter from the storm (NIST Interview 58).

¹³⁸ This statistic does not include the one family that had access to a crawl space and did not use it because they had access to a storm shelter. The statistic does encompass eight couples, each located in a separate home, in which neither spouse chose to access the crawl space. It is not clear if these were joint or individual choices.

thought it would be too muggy and too scary under there. (NIST Interview 84)

NIST spoke with a few individuals who did not take protective action or shelter before the storm hit (or knew of someone inside their home who did not take shelter). At one home, an elderly husband and wife who were both hard of hearing were unaware that a tornado was heading right for them. Just as the woman walked up to light a few candles near a window

the glass window—doors—blew in and knocked me 18 foot across the room and into the hall. As I went through the hall door, the door frame and door fell down. All of a sudden, I realized—I quit flying, and I was laying in a puddle of water and glass. My husband started yelling, come help me. He had—the recliner he was sitting in had turned over, so he was pinned under the recliner and wood and sheetrock debris. (NIST Interview 118)

In another instance, a husband decided against taking refuge with his wife and son (who protected themselves in the interior hallway), and instead, remained in his bedroom while the tornado ripped apart his home (NIST Interview 40). The husband died, while his wife and son survived, albeit with injuries.

Some people were thrown from their houses, others lifted up in place, desperately holding on to pipes, appliances, and each other. A couple who was visiting family was sheltering in a bathroom with four other adults, when the tornado grabbed hold of the wife:

And it just felt like somebody took and grabbed me by my waist and just jerked me back as hard as they could. And it just felt like we were flying, but actually we were going down to the ground, but it didn't really have that sensation. It just felt like we were flying. And so, we kind of stopped. And then—and my husband—when my nephew threw the mattress in, he grabbed a hold of it and he was holding it in front of me and he was partially underneath it or behind it but not totally. So, whenever we stopped, walls started falling on us. And then we went again. It pulled us even more. And, again, it just felt like, you know, we were not really landing on the ground, but going backwards. (NIST Interview 52)

The walls and roof that eventually caved in upon them were stopped by the hot water tank, which the couple credits for saving their lives.

Other individuals were actually taken up into the air by the storm. A man who was sitting inside his bathroom, on top of the toilet, heard his house ripping apart around him. He recalled: “The next thing I knew I was jerked rather violently airborne. Swung out the house, or swung out into space somewhere. I remember a 360 in the air, next thing I was skidding across the yard and came to a stop” (NIST Interview 11). Another interviewee also sheltering in his bathroom had hunkered down in the bathtub as the storm hit his house. He remembered the following:

When I was sitting there in the bathtub the roof got ripped out that portion of the house, and I could feel my feet were getting pulled up in the air, and I was actually holding on to the bathtub faucet. My feet—I

was kind of—pretty much—well I was at a 45-degree angle in the air for probably a good few seconds, and then some debris from I think my neighbor's—pretty sure my neighbor's house ended up falling on me and holding me back down. That's probably the only point that I really—it really kind of made me feel that I was really in danger. (NIST Interview 30)

Interviewees suffered anywhere from no damage to their house to the entire house being scraped off of the foundation, with nothing left. Fig. 4-14 shows a foundation and ground floor, all that was left of a house located within the damage path, along with the occupant's vehicle, which before the storm was in the garage. The winds even ripped some of the tiles and carpeting from the floor of this house. The occupant was sent flying into the storm as his house was ripped apart; however he did not suffer any life-threatening injuries.

A total of 74 people died at home due to injuries sustained from the tornado; 62 individuals in single-family homes and 12 in multi-family apartment complexes. The locations of these deaths are displayed in Fig. 4-15. The 62 deaths in single-family homes included two individuals who suffered stress-induced heart attacks at home, and later died in a hospital. The homes of these two individuals were not damaged. The 62 deaths also included one individual whose final cause of death was pneumonia, from which he or she died 2 months after the storm hit. The death certificate for this person cited congestive heart failure and dementia as secondary causes of death. It is unclear whether stress or taking refuge from the tornado was the cause of this person's fatal injury, since no damage occurred to the home. Finally, 14 of the 62 deaths involved people who were injured in their homes due to impact-related causes, and then died later in hospitals (days, weeks, or months after May 22, 2011), according to their death certificates. All 12 deaths that occurred in multi-family apartment complexes were caused by impact-related injuries and all but one of these deaths occurred during the storm, according to their death certificates.



Figure 4-14. Demolished home located within the tornado damage path in Joplin.

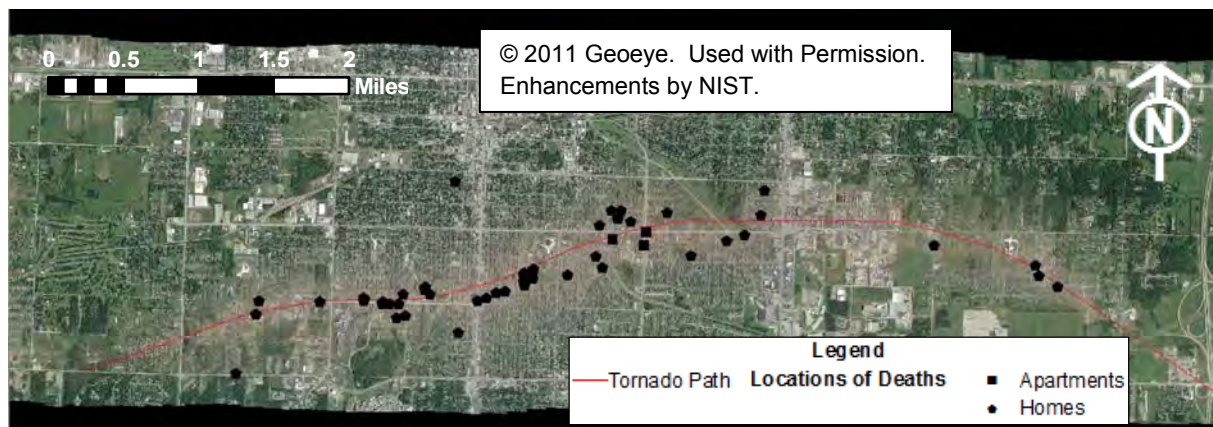

Figure 4–15. The geographic locations of deaths in homes and apartments in Joplin. Detached homes are designated by pentagon shapes and apartments by square shapes, with the red line indicating the estimated center track of the tornado.

NIST focused a significant amount of effort to ascertain whether the fatally injured took refuge inside their homes, and if so, where they were sheltering when the storm hit. Twenty of the 62 persons who died from injuries sustained in single-family homes on May 22, 2011 had taken internal shelter (note: three sets of 2 people each and one set of 3 people were together in the same houses), 9 did not take shelter, and the sheltering actions of the 33 remaining decedents are unknown (note: three sets of 2 people each were together in the same homes). Many of these 33 are thought to have been alone or with someone else who died in the storm, making it difficult to find accurate information on their refuge locations when the storm hit their houses. Of the 12 people who died from injuries sustained in apartment buildings, 2 had taken shelter within their apartment (they were located together in a bathroom), 1 did not take shelter (he was sleeping in his room when the storm hit), and the refuge locations of the remaining 9 fatalities are unknown.

Only 3 of the 62 persons fatally injured in single-family homes had access to a basement. These three individuals had access to partial basements, some portions of which were underground. Further research revealed that two of the three individuals did not go to their basements before the storm hit, and instead remained above ground (i.e., one was sleeping and the other remained sitting in his or her chair as the storm hit) (CBSNews 2011a, 2011b; NIST Interview 13; American Red Cross Disaster Health Services Mortality Report Form). As for the third fatally injured individual who had access to a basement, no information was found on whether he or she took refuge in the basement or remained above ground as the storm hit.

NIST was also interested in the locations of injured individuals throughout the Joplin area. However, due to the sheer number of injuries, NIST was unable to obtain information on the location of each injury that occurred in single-family or multi-family homes. A total of 34 individuals were interviewed as part of the CDC EPI-Aid Study, all of whom spent some time in the hospital for their injuries. Looking only at

the severely injured individuals within this sample, none of these 19 severely injured individuals had access to a full or partial basement within their homes or complexes.¹³⁹

4.4.11 In Vehicles or Outdoors

Twenty fatalities occurred outside of structures on May 22, 2011. These were among individuals who were in transit, stopped in vehicles, or caught outdoors when the tornado struck. NIST spoke with 13 survivors who were located inside their vehicles and 2 individuals who were located outdoors when the tornado struck. Fig. 4–16 shows the locations of these 15 survivors whom NIST interviewed. NIST also collected information on 18 individuals who were injured in vehicles (from the CDC dataset) as well as on the 20 individuals who died outside of structures (12 were located in vehicles and 8 were located outdoors).

Very little information could be gleaned from those who were injured or killed in vehicles or outdoors about how they received information prior to the storm, as NIST was not able to speak with any survivors who were with these persons before the storm hit. CDC’s dataset of the injured did not include information on tornado awareness. Information about the receipt of warning information by people who were in vehicles or outdoors during the storm was obtained from the 15 survivors who spoke directly with NIST, as well as from media accounts. Information on refuge locations within vehicles or outdoors was obtained for survivors (both NIST interviewees and the injured from the CDC sample) and fatalities.

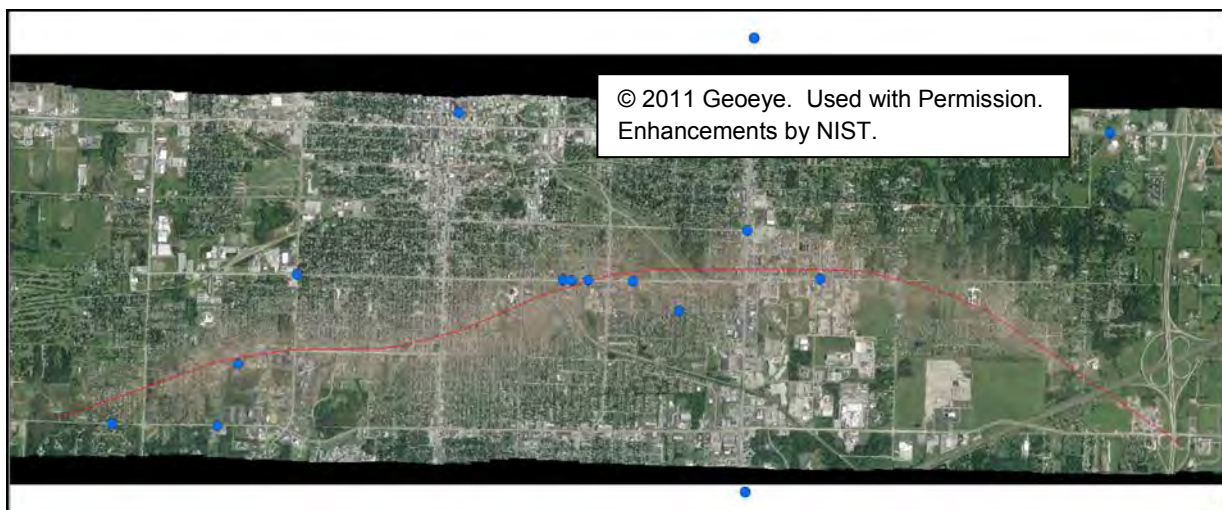

Figure 4–16. Geographic locations of NIST interviewees located outside of structures when the storm hit (13 individuals were in vehicles and 2 were outdoors). The red line represents the estimated center track of the tornado. Note: Two interviewees were located slightly beyond the boundaries of the aerial photograph; their locations are shown to scale.

¹³⁹ Five of the 34 injured individuals had injuries the severity of which is unknown because not enough information was available on the injury.

Persons who were already in their cars or who were located outdoors received initial alert/warning information via the 5:11 p.m. sirens and/or car radio–disseminated weather reports about the 5:09 p.m. tornado warning for the northeastern storm. Additionally, loved ones called to let individuals know that the tornado sirens were sounding or that the NWS had warned that a tornado was possible in northeastern areas of Joplin. There were also a few among this group who were initially located indoors (i.e., in public businesses throughout Joplin) and were made aware of the event by business staff.

Similar to those in homes, no matter how these individuals received initial alert or warning information, very little information was available to confirm the existence of a threat for those located in what soon became the tornado’s damage path. People tuned into their car radios to hear that the storm was to the north, called or received calls from others and discussed the northern storm, or looked to the environment, which showed little of the tornado–related cues needed to prompt people to act. Additionally, the actions of others in the City of Joplin provided little in the way of threat confirmation. At 5:11 p.m., when sirens were heard at the Joplin High School graduation ceremony, for example, an interviewee noted that “the attitude of people that were outside was still very much in the festive, you know graduation day–type mode, taking pictures and hugs and you know that kind of thing. Didn’t see a lot of people like running for their cars or heading for shelter” (NIST Interview 15).

Therefore, the individuals in vehicles or outdoors generally proceeded with their activities. These included continuing Sunday errands, traveling to work, or traveling to family dinners, especially to celebrate high school graduations. Some decided to travel to their next destination, as long as it was not located to the north (i.e., where storms were possible). Others decided that they wanted to go home, for example, to be with their spouse or to take care of their dogs; however, these decisions were based on a belief that they were not in any immediate danger and could safely continue driving around Joplin.

As they continued on in their cars, many monitored the conditions and potential impending storm via their vehicle’s radio. However, depending upon the radio station that they listened to, they received different information about the weather. Interviewees recalled the following examples of information provided to them during this time period:

- There was a tornado in Carthage, Missouri (but nothing was said about a tornado on the ground in Joplin) (NIST Interview 26)
- There was bad weather in Kansas, and it was heading east (however, no specific locations were provided) (NIST Interview 28)
- There was a tornado warning (but with no specific information about any tornadoes on the ground) (NIST Interview 46)
- There was a tornado between Carl Junction, Missouri, and Webb City, Missouri (NIST Interview 60)
- A tornado was spotted in Joplin at 7th Street and Schifferdecker Avenue, and then later, a tornado was spotted at the interviewee’s location (however, he did not experience the effects of a tornado at that particular location) (NIST Interview 66)
- The storm was moving to the northeast (NIST Interview 71)

- A tornado was hitting Carl Junction, Missouri (located northwest of Joplin) (NIST Interview 130)

In some of these cases, interviewees were looking for specific information that a tornado had actually touched down before they were willing to take safety precautions, including stopping their cars.

The two interviewees who were located outside when the storm hit were attempting to gain access to structures. One of them, who was caught outside of his home without his keys, was attempting to gain entry as the storm hit. He described the tornado approaching as he attempted to open the front door:

I grabbed the storm door and opened it up, and I kicked the front door about half a dozen times like you see on the police shows. It didn't budge. Didn't move an inch. And so turned around and our neighbors had been out—the neighbors to the south of us had been out when we got home looking at the sky like everybody does around here. And I thought, well, we can run over there. Well, by the time I turned around and [headed] back to the edge of the porch, it was raining so hard you couldn't see their house 20 feet away. So I ran back to the front door and about that time, over [girlfriend's] shoulder—she had turned around and over her shoulder out in our front yard, a couple 8-foot lengths of 2 by 4 landed in our front yard. And I—that kind of startled us and about that time the corner post that holds up the roof—the whole roof line goes down over the porch, too. And the corner post that holds it up over the edge of the porch just crumbled, just fell to pieces. The roof started coming down on us. (NIST Interview 28)

The other outdoor interviewee was attempting to access a local grocery store when the tornado hit. Since the store had already locked its doors, the interviewee and her husband took refuge in the store's alcove (i.e., right outside the front doors). Luckily, this store was not hit as hard as others, and remained intact throughout the storm.

Of the 13 interviewees caught inside their vehicles as the storm moved through Joplin, 10 directly felt the effects of the tornado in some manner while in their vehicles. As the tornado moved closer and the debris wall grew thicker, these drivers were unable to see the road ahead of them, so they pulled their cars over, stopped, and hunkered down, hoping for the best. One mentioned that she had “seen a car a little bit in front of me blowing across the street” (NIST Interview 26). Another interviewee mentioned seeing the following conditions:

Wind picking up and things flying through the air—small things—nothing major. And then in between 17th and Range Line and 20th and Range Line is whenever I could see from the west it was very dark, and it's like a wall of dirt, basically, and I guess it's the outside stuff in the air finally got to the street or the road or whatever you want to call it. And that's whenever—and it basically kind of just made it disappear, 'cause it was so thick. And that's whenever things started getting more serious, like in your head you're running through your mind, “Okay, I probably don't need to be here.” (NIST Interview 66)

An analysis of the interviewees who were driving when the storm hit showed that all but one of them drove directly into the most dangerous parts of the tornado. (The remaining driver, who was sitting in her car in a parking lot throughout the storm, was also located within the strongest portion of the tornado.) The rain-wrapped nature of the tornado (see Chapter 2), compounded by the presence of a significant number of structures, trees, and hills between the drivers and the tornado, and the large volume of dirt and debris surrounding the storm, were likely contributors to this behavior. A couple near 20th Street and Delaware Avenue recalled that “the sky had just went all black. You couldn’t see anything, and it was raining really hard” (NIST Interview 26). The notion of the tornado, from the driver’s perspective, not being “seen” clearly or at all was confirmed in a number of interviews, and corroborated through surveillance videos. An individual driving near West 32nd Street and Westberry Lane mentioned that he “could see a wall of water that was about 200 yards ahead of me and I just assumed that was the straight-line winds” (NIST Interview 15). Another interviewee at 20th Street and Rhode Island Avenue described the tornado as “a wall of clouds moving at me. It was still grey, but it was getting darker, and darker” (NIST Interview 60). After the clouds, he just started seeing a lot of debris. For these individuals, visibility was limited, probably to only 10 ft to 15 ft, causing many to pull over and wait out the storm that they were not certain was a tornado (NIST Interview 66).

While interviewees who were located in vehicles recalled getting pummeled by debris (through broken windows), some even suffering severe injuries as a result, a van was picked up by the storm on Rhode Island Avenue, off of 20th Street in Joplin. An interviewee had turned onto Rhode Island Avenue, desperately trying to find someone, anyone, with whom he could take shelter. When he did not see anyone, he noted that he never felt more alone and empty, “because I just knew something bad was about to happen . . .”

at that moment the windows exploded. I thought the windshield went out first, but actually seeing the photographs, it didn’t go anywhere. But everything else. The back window—side panel windows. They all just exploded. And that part I saw in slow motion. I saw the windows—because see, a lot of people talked about feeling pressure and their ears pop. I didn’t feel that. My ears didn’t pop. My first indication was when the windows exploded—debris came flying through. I’m laying over in the seat. And was laying—I know I was laying there for, you know, a few seconds. I was laying there for ten, fifteen seconds. It’s always hard to gauge. But stuff’s flying over the top of me.

Then it was like a giant hand picked me up. Didn’t pick me up. But it pulled me straight back to about where these red cars were, and everything and that. And I don’t know if I hit them. Because it felt like I bumped into something. But the minute I bumped into something, I went straight up. And I went. And I don’t really have a gauge how high I went up, except that I felt like I really lifted and went straight up. But now the thing is spinning the whole time. I’m spinning counterclockwise the whole time this is going on. Seconds. It was only seconds. But I saw debris flying around me. And I saw these things breaking apart. And about 30 or 40 seconds later, you couldn’t see. You couldn’t breathe. (NIST Interview 60)

A total of 12 individuals located in 11 different vehicles died due to injuries sustained from the tornado. All 12 of these deaths were caused by impact-related injuries and occurred on May 22, 2011, according to the death certificates. Due to the sheer number of injuries to individuals located in vehicles or outdoors, however, NIST was unable to collect or analyze information on each such injured individual.

Among persons located outdoors during the storm, eight fatalities were attributed to the tornado. These fatalities included a police officer killed in the line of duty on Monday, May 23, due to a lightning strike. Also included in the eight deaths were the following: one individual located outside of SJRMC, who had been dropping someone off at the Emergency Room entrance; one individual located outside of the Greenbriar Nursing Home when the tornado hit; and three individuals who worked for Jasper Food Products and took refuge in a ditch.¹⁴⁰ With the exception of the police officer, all fatalities that occurred outdoors were caused by impact-related injuries and happened on May 22, 2011, according to the death certificates. The locations of deaths in vehicles (indicated by red and blue highway signs) and outdoors (indicated by black diamonds) are shown in Fig. 4–17, in relation to the estimated center track of the tornado.



Figure 4–17. The geographic locations of deaths that occurred in vehicles (indicated by the red and blue highway signs) and outdoors (black diamonds) when the storm hit. The red line is the estimated center track of the tornado. Note: Multiple deaths occurring at the same location are represented by only one symbol.

It should be noted that a small subset of NIST interviewees were “in flux” during the storm; that is, they were in a vehicle at some point between their initial awareness of a possible tornado and the time when the tornado hit. Since they were not located at one of the places where deaths occurred, and they were not located inside a vehicle when the tornado hit, they were not included in the preceding portions of this chapter. These individuals began the event in one building, decided that it was safe enough to drive (or relocate) at some point before the storm hit, and ended the event (when the tornado hit) in another building.

NIST spoke with two “in flux” interviewees who were located at home when the initial alert and warning information was provided, but then relocated to another building they perceived as safer in case a tornado

¹⁴⁰ The cause of death listed on the death certificate for the three who took refuge in a ditch was not drowning, but rather blunt-force trauma to the body.

hit. One individual took refuge nearby at the SJRMC (NIST Interview 80) and another sought protection in a convenience store located across the street from his or her apartment complex (NIST Interview 136). These responses constituted a small minority of the storm responses among NIST interviewees, who were more likely to stay at home (or return home) after receiving alert or warning information, rather than travel to another building. There were additional “in flux” individuals who received alert or warning information in one building (not their home) and then traveled to another building (continuing on with their errands). These individuals did not feel at risk during their travel, deciding that the storm was to their north and that as long as they kept to the south, they would be fine. The final group of individuals “in flux” during the storm included those who stopped to take refuge in a location to which they were not originally traveling. A woman in this group recalls her “close call” on 20th Street that evening:

We was on 20th Street before we even knew there was gonna be a tornado. And so the wind and everything started picking up, we looked up in the sky, and there was the funnel. So when we got to 20th and Main, it just whipped our truck all over the place, and we had a hard time getting it to stop, and we was in the truck. And the windows and everything started breaking out, so we decided to go over to the store there on 20th and Main to try to go in for shelter. (NIST Interview 125)

4.4.12 Additional Locations of Fatalities in Joplin

An additional three fatalities, which were not discussed in the preceding sections, were attributed to the Meadows Healthcare facility (two deaths) and the Golden Corral restaurant. Meadows Healthcare was a nursing home located at 1805 West 32nd Street in Joplin. NIST did not speak with any individuals who had been inside this structure when the tornado hit. Additionally, the damage to this facility and the response of its residents and staff received very little media coverage. Two deaths occurred at this nursing home, and although both were caused by blunt-force trauma to the body, the death certificates also noted that at least one of these patients was suffering from cancer. Both deaths attributed to Meadows Healthcare occurred 2 days after May 22, 2011.

One death was attributed to the Golden Corral restaurant, according to the death certificate. However, this attribution was likely made because the restaurant was the last place that anyone saw or heard from this individual. The conditions inside the Golden Corral are not analyzed in this report, since it is likely that this individual died in another location.

4.5 CASUALTIES FROM THE MAY 22, 2011, JOPLIN TORNADO

The May 22, 2011, Joplin tornado caused devastation throughout the city and beyond—destroying homes, businesses, churches, apartments, and other facilities, and leaving many injuries and deaths in its wake. This chapter has so far explored two main topics related to this devastation. Sec. 4.3 described conditions that existed in Joplin prior to the tornado and were relevant to how people responded to the storm on May 22, 2011. These conditions included the emergency communications infrastructure, sheltering options, and prior exposure to tornadoes among the populace. Sec. 4.4 described how people responded to the impending threat of storms and to the tornado itself on May 22. This encompassed how people became aware of possible weather threats and of the tornado; where people were before and during the tornado, and why they were there; how these locations influenced people’s response options; whether, when, and how people sought to protect themselves and others; and the outcomes associated with these various

locations, options, and behaviors. The present section focuses on the casualties (deaths and injuries) caused by the tornado, to provide insight into additional factors (beyond pre-existing community conditions and individuals' circumstances and behaviors on May 22) that may relate to how people were impacted by this storm. These factors include where and how people were killed and injured, when victims died, and the basic demographics (i.e., gender and age) of those killed or injured.

The May 22, 2011, Joplin tornado produced the largest death toll for a single U.S. tornado since record-keeping began in 1950, taking the lives of 161 people at various locations throughout the city. In addition to the fatalities, there were many survivors who were injured in the storm. The City of Joplin attributed more than 1,000 injuries to the May 22, 2011, Joplin tornado.¹⁴¹ As indicated in Sec. 4.2, NIST was unable to obtain detailed information on each of the injuries attributed to the tornado, and consequently focused its analyses on the fatalities. However, some helpful information on injuries was gleaned and is presented here from both the larger ESSENCE dataset (of 876 individuals who visited emergency rooms in Missouri due to injuries from the tornado) and the smaller sample of 71 injured persons who were randomly selected from the ESSENCE dataset and studied by the CDC. These injury data provide examples that support the information presented here on fatalities.

4.5.1 Settings in Which Fatalities Occurred

Over half (57 percent) of the 161 deaths occurred in residential structures, which included apartment buildings, single-family residences, and the Greenbriar Nursing Home. Approximately 13 percent of the fatalities occurred in Joplin businesses, including retail stores and restaurants as well as the Elks Lodge (this statistic does not include the fatality attributed to the Golden Corral). Twelve percent of the fatalities happened outside of buildings, either in vehicles or outdoors (outside of any protective enclosure). Of those that occurred outside, one death involved a police officer killed in the line of duty on Monday, May 23, 2011. Two others involved a person who was located outside of SJRMC dropping someone off at the Emergency Room (a death that other analyses may attribute to SJRMC) and an individual who was outside of the Greenbriar Nursing Home (a death that may arguably be attributed to the Greenbriar Nursing Home) when the tornado hit. Eight deaths occurred in places of worship, and three deaths took place in Joplin's Stained Glass Theater. Finally, 16 deaths occurred in hospital facilities, including the Meadows Healthcare facility and SJRMC.

4.5.2 Basic Causes of Deaths and Injuries

Nearly all of the deaths (96 percent or 155 out of 161) were caused by impact-related injuries, according to information contained in death certificates. An impact-related cause of death means that the death certificate cited "multiple blunt force trauma to body" as the immediate cause of death. In speaking directly with the medical examiner in Joplin, NIST found that the policy in the Joplin coroner's office was that autopsies were not performed unless a death was suspicious in nature. For the fatalities from the May 22, 2011, Joplin tornado, the coroner performed visual and dental assessments and took X-rays to obtain the cause of death. In most cases, deaths from the tornado were labeled as "blunt force trauma." In instances where the death certificate also described how the injury occurred, impact-related deaths were almost always listed as "struck by debris from tornado."

¹⁴¹ *Community Press Kit* issued for the Day of Unity observance, May 22, 2012, <http://www.joplintornadoanniversary.com/resources/community-press-kit.pdf>.

Other deaths occurred due to non–impact–related factors. Three non–impact deaths occurred in single–family homes where two individuals died of heart attacks due to stress brought on by the storm, and one individual died of pneumonia.¹⁴² In all three of these cases, the storm did not damage the victim’s home, but the death was attributed to the storm due to the stress it caused to the individual. Heart attacks that led to deaths were also determined to be the cause of two of the fatalities that occurred at SJRMC. The sixth and last non–impact–related death was of the police officer who was killed by lightning in the line of duty on Monday, May 23. All of the non–impact–related deaths occurred after May 22.

In the 71–person CDC injury sample, the extent of injuries varied significantly. Thirteen of the injured suffered from fungal infections (which were likely consequences of their impact–related injuries). All but one of these 13 individuals were either admitted to an ICU and/or spent 8 or more days in the hospital, thus meeting this study’s criteria for a severe injury. Explanations for injuries included the following: multiple abrasions, lacerations, and/or fractures from being struck or hit with flying debris. Additionally, the more severely injured individuals also suffered from blunt trauma, penetrating trauma, and brain injuries, sometimes having been knocked unconscious for some period of time. The circumstances leading to these injuries, both severe and non–severe, were often that individuals were thrown from their location (or out of the structure in which they were located) by the tornado, crushed by the structure or surrounding debris, or struck by flying debris of different types and sizes and with varying force.

4.5.3 Date of Death

Most of the people killed by the tornado (77 percent) died on the day that it occurred, May 22, 2011. This group included all of the fatalities that occurred at the AT&T store, Elks Lodge, Full Gospel Church, Golden Corral,¹⁴³ Harmony Heights Baptist Church, Home Depot, Pizza Hut (the one located at 1901 South Range Line Road), and Walmart (Store #59). Additionally, all deaths attributed to an outside location or to a vehicle also happened on May 22.

In some cases, however, deaths were attributed to the location where the individual was injured, while the person actually died later elsewhere. Six of the 19 deaths attributed to the Greenbriar Nursing Home, for example, were of persons injured at the nursing home who were later transported to a hospital where they subsequently died from their tornado–related injuries. One of these six deaths occurred 4 days after the tornado, four occurred in June 2011, and one occurred in September 2011. The two individuals who were fatally injured at the Meadows Healthcare facility both died 2 days after the storm hit. Seventy–nine percent of the people who were fatally injured at home (in both single–family homes and apartment buildings) died on the day of the storm, while 21 percent died later in other locations (these percentages do not include the two individuals who suffered stress–induced heart attacks at home due to the tornado, and later died in a hospital). At SJRMC, five patients died on May 22, 2011 during or after the tornado. The nine other deaths attributed to SJRMC involved individuals who were injured at the hospital during the storm, including two patients who suffered stress–induced heart attacks, but died in other hospitals or locations days, weeks, or months later.

¹⁴² It is unclear whether stress or taking refuge from the tornado was the cause of this person’s storm–related injury, since no damage occurred to the home of this fatally injured individual.

¹⁴³ A death certificate indicates that one individual died at the Golden Corral, not necessarily because he or she died on the premises, but mainly because this was the last place where anyone saw or heard from this individual.

4.5.4 Demographics

The demographic information that could be obtained for the deaths and the majority of the injuries was gender and age. Gender is discussed first, then the age distribution of deaths, followed by the age distribution of those injured by the tornado. The age analyses for deaths and injuries are presented separately because the age data for these two populations were provided to NIST in different ways.

4.5.4.1 Gender

Gender distributions were calculated for the fatalities and the sample of injured persons. Gender information for the fatalities was provided by the death certificates (total = 161), and the gender distribution for this group was as follows: 54 percent female (total = 87 dead) and 46 percent male (total = 74 dead). Information on the gender of injured persons was provided by the ESSENCE injury dataset (total = 876). The gender distribution for the injured persons who were residents of either Jasper or Newton Counties was as follows: 52 percent female (total = 398 injured) and 48 percent male (total = 364 injured) (total of 762). Additionally, the gender distribution for the injured who were residents of places outside of Jasper and Newton Counties was as follows: 48 percent female (total = 55 injured) and 52 percent male (total = 59 injured) (total of 114). Residents of other counties (outside of Jasper and Newton Counties) may have been visiting Joplin at the time of the storm or staying in one of the health care facilities in Joplin. Overall, there was nominally an equal distribution of men and women among the tornado fatalities as well as in both groups of injured persons.

4.5.4.2 Age—Deaths

The average age of the persons killed by the May 22, 2011, Joplin tornado was 55 years old, \pm 23 years (one standard deviation from the mean), with the median age of fatalities being 58 years old. Fig. 4–18 shows the age distribution of the 161 fatalities attributed to the May 22, 2011, Joplin tornado, graphed by 10-year age range. The graph shows that approximately 46 percent of the fatalities were aged 60 years or older, and further analysis revealed that approximately 38 percent of the fatalities were 65 years old or older. Fig. 4–18 also compares the Joplin fatalities with U.S. tornado fatalities (by age) from tornadoes that occurred between the years of 1996 and 2007 (Simmons and Sutter 2011); some studies of U.S. tornadoes have found older populations (above 65 years of age) to be more vulnerable to casualty than other age groups (Moore 1958; CDC 1985; Sanderson 1989; Carter, Millson, and Allen 1989; Lillibridge 1997; Fernandez et al. 2002). Fig. 4–18 shows that compared with age statistics from previous U.S. tornadoes, an even higher percentage of individuals 60 years of age and older died from the Joplin storm.

However, it is possible that the tornado struck an area of Jasper County with a higher number of older individuals (aged 60 years and above). Therefore, it was important to compare the ages of Joplin fatalities with the distribution of ages in Joplin, as well as with the distribution of ages within the area most affected by the tornado. This information is presented in Fig. 4–19.

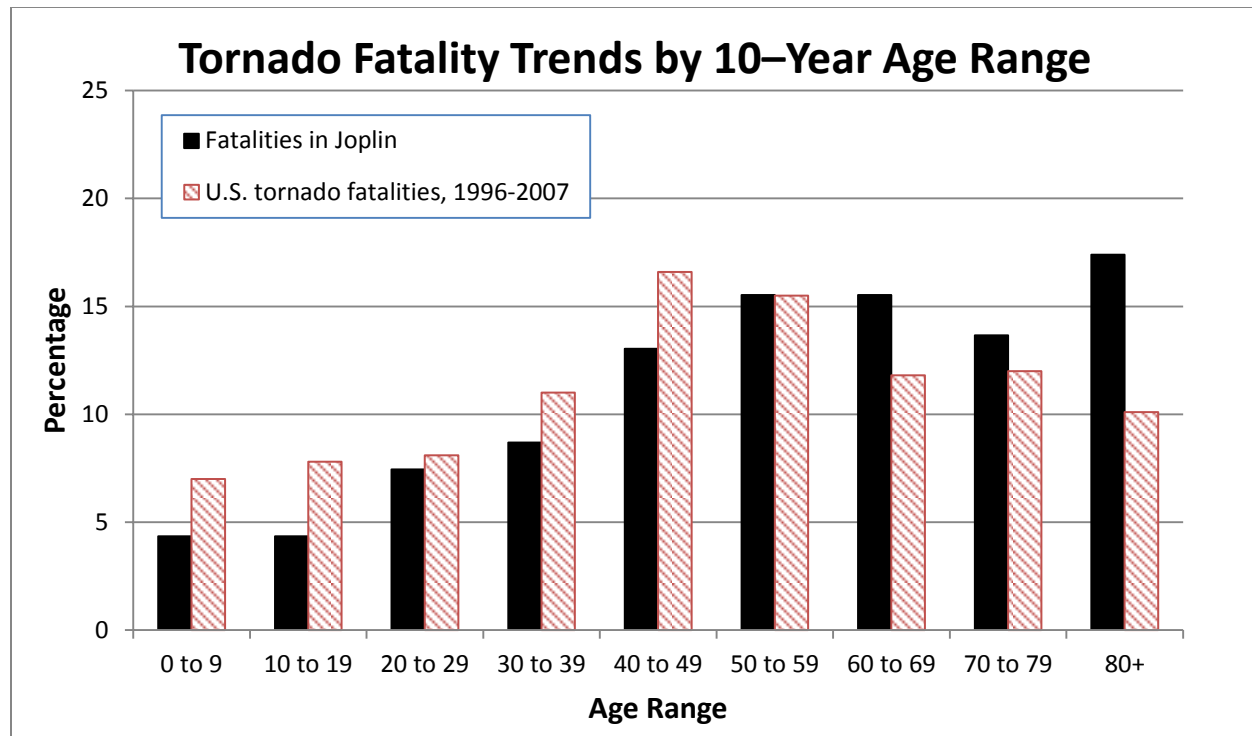

Figure 4–18. Comparison, by age, of the 161 fatalities from the May 22, 2011, Joplin tornado with U.S. tornado fatalities from 1996 through 2007 (Simmons and Sutter 2011).

Fig. 4–19 displays fatality rates per age range for all 161 fatalities. The graph shows fatality rates for two different populations: the population of the Joplin area (U.S. Census Bureau 2010) and the population of the six census tracts within Joplin (104, 105, 106, 107, 108, and 109) that encompassed the tornado’s damage path.¹⁴⁴ A map of these census tracts is provided in Fig. 4–20.

Because the damage path included only two blocks within census tract 109, NIST also determined the age distribution of the population within those two blocks plus tracts 104 through 108. No difference in age distribution was found between the area that included all of tract 109 versus the area that included only the two affected blocks of tract 109. The population of the former area totaled 29,908 people and of the latter area totaled 26,864 people.¹⁴⁵

When comparing fatality rates among each 10–year age range, Fig. 4–19. clearly shows that there was a disproportionate number of fatalities among those ages 40 and above. The disproportion was even more exaggerated for those 60 years old and above. For example, in the area that encompassed the tornado’s damage path, 18 people per thousand died within the age range of 80 years old and above, compared with rates of approximately 2 people per thousand for those aged 29 and below.

¹⁴⁴ Source: City of Joplin Building Division.

¹⁴⁵ Note: The numbers calculated from the Census tracts reasonably approximate the population estimates made by the U.S. Census Bureau for the Joplin tornado damage path (about 20,820 people, U.S. Census Bureau 2012); www.census.gov/newsroom/emergencies/2011_tornadoes.html.

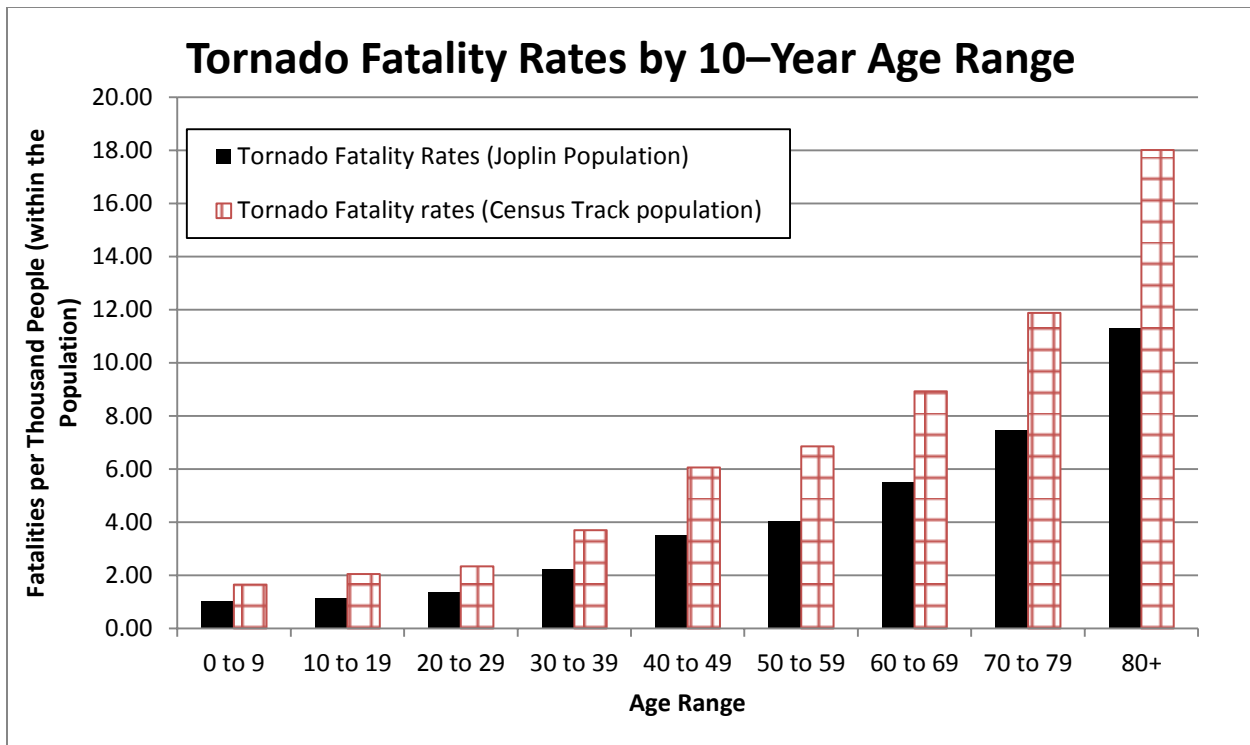
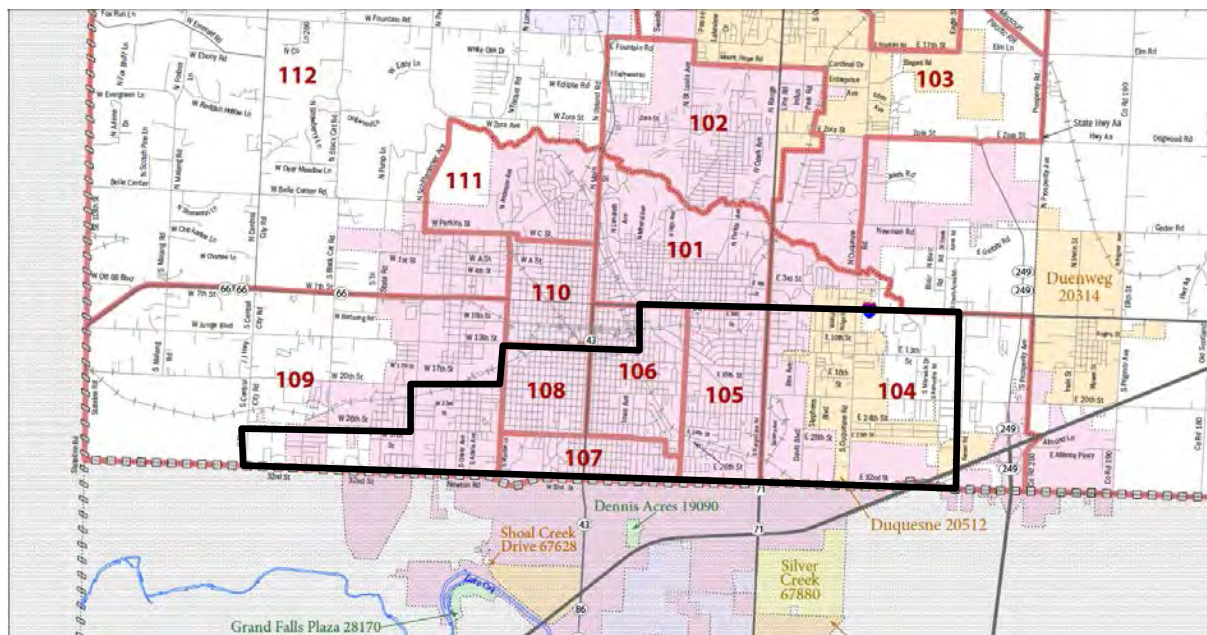

Figure 4–19. Comparison of fatality rates per thousand people within two populations: Population 1 – the entire population of Joplin and Population 2 – the population of the areas within Joplin most affected by the tornado (U.S. Census Bureau 2010).



Source: http://www2.census.gov/geo/maps/dc10map/tract/st29_mo/c29097_jasper/DC10CT_C29097_001.pdf.

Figure 4–20. Census tracts in Joplin that were affected by tornado damage.

4.5.4.3 Age—Injuries

A similar trend was found among the May 22, 2011, Joplin tornado’s injured population. From the ESSENCE dataset of 876 people, age range data were provided for 856 people (20 people were labeled as age = “unknown”). Overall, ages were provided for the 752 injured people from Jasper and Newton Counties and 104 injured people from areas outside of these counties (their locations were not specified by the data collectors). Figure 4–21 shows the injury rates for the 752 people from Jasper and Newton Counties, since their county location is known, and thus overall population numbers in the two counties could be obtained for rate calculations. Similar to the fatalities analysis, the injury rate for persons who were aged 65 or above was larger than (approximately double) the rates of injured persons who were less than 65 years old (using population statistics from the 2010 U.S. Census).

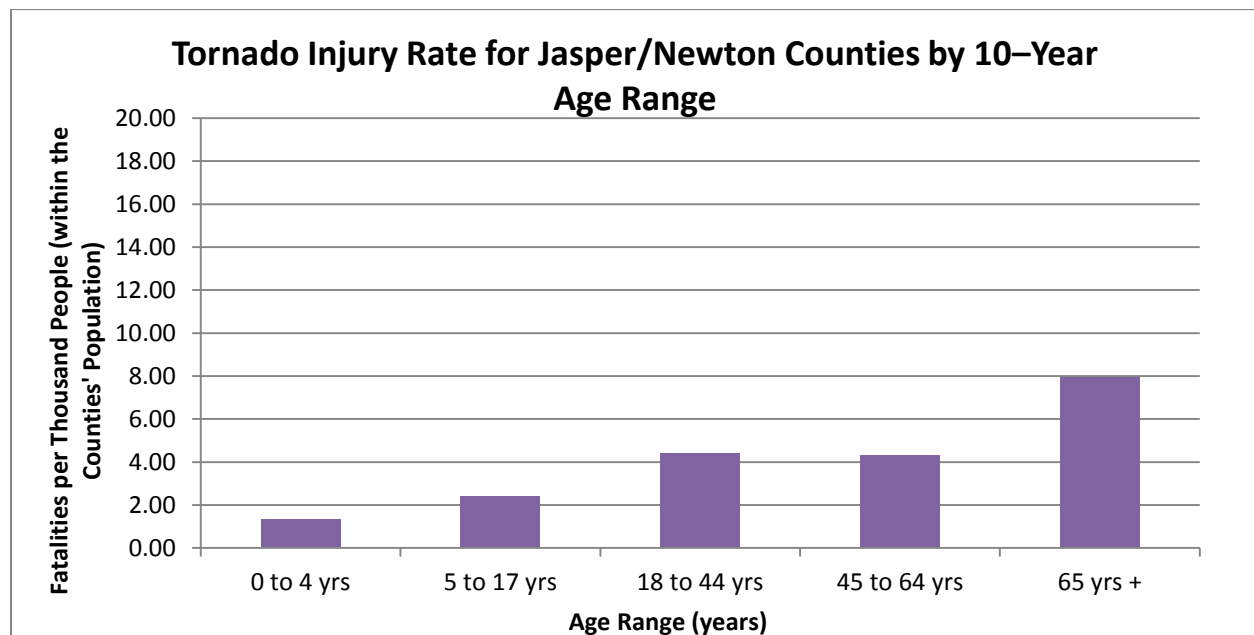

Figure 4–21. Tornado–related injury rates by 10–year age range for residents of Jasper and Newton Counties (U.S. Census Bureau 2010).

4.5.5 Summary Questions and Findings Related to Casualties

As mentioned earlier in this section, most (96 percent, 155/161) of the 161 deaths attributed to the May 22, 2011, Joplin tornado were caused by impact–related injuries. In these instances, the death certificate cited the cause of death as “multiple blunt force trauma to body.”

Additionally, it was determined that 12 percent of the overall fatalities occurred in locations outside of structures, either outdoors or in vehicles. Whereas it is conceivable that individuals located outdoors during a severe tornado could suffer grave consequences, what protection, if any, did vehicles provide? Also, what wind speeds were correlated with fatal (or severe) injuries among individuals located outside or in vehicles during the tornado? The answers suggested by NIST’s analysis of the May 22, 2011, Joplin tornado will be provided in the following section (Sec. 4.6).

It was also determined that 87 percent of the overall fatalities occurred inside structures.¹⁴⁶ These structures included both non-residential and residential structures. This finding prompts the following questions: What level of protection was offered by the buildings in which individuals died or were severely injured as a result of the May 22, 2011, Joplin tornado? Did the individuals who were fatally or severely injured have access to basement areas, and if so, did they take advantage of these underground areas? Why did 135 individuals die from impact-related or blunt-force trauma wounds to the body when they were located inside structures throughout Joplin? These questions will also be addressed in the following section.

Finally, an analysis of the ages of those killed and injured in the tornado indicated that the age of individuals may have influenced their likelihood of being killed or injured. Overall, a disproportionate number of people aged 60 years and older died or were injured as a result of this tornado.

4.6 THE INFLUENCE OF ENVIRONMENTAL CONDITIONS ON CASUALTIES

The purpose of this section is to identify the factors related to the *impact-related deaths and severe injuries* that resulted from the May 22, 2011, Joplin tornado—both outside and inside of structures. This analysis focused primarily on the deaths that occurred as a direct result of the May 22, 2011, Joplin tornado, i.e., impact-related causes, rather than those caused by stress or stress-related factors. People who survive the physical impacts of any type of disaster experience stress, and this event-induced stress can and does kill a small number of survivors after the event is over, for example, by increasing the rates of acute myocardial infarction, other forms of ischemic heart disease, suicide rates, and more. Highlighting impact-related deaths that can be specifically attributed to the tornado, rather than any type of emergency event, will help to more clearly identify the tornado-related causal factors of death and injury, which can lead to improvements in life-safety systems for tornado-prone areas. Table 4-3 provides a tally, by location, of the 154 impact-related fatalities¹⁴⁷ used in this analysis to better understand the causes and patterns of deaths directly resulting from the tornado.

Seven of the 161 deaths attributed to the May 22, 2011, Joplin tornado have been omitted from this analysis and were not included in Table 4-3. These seven omissions include six non-impact-related deaths plus the fatality attributed to the Golden Corral restaurant, which was omitted because the final location of injury (and death) for this individual remains uncertain. The six non-impact-related deaths, which were described in Sec. 4.5.2, were not included in this analysis because the causes of injury (and ultimately, death) in these cases were factors not specific to tornadoes.

Some of the 154 deaths included in this analysis were of people who died days, weeks, or even months after the tornado hit Joplin, sometimes from illness (e.g., pneumonia) rather than solely from the injuries they sustained in the tornado. They were included because their death certificates specifically stated that they were injured by debris from the tornado.

¹⁴⁶ This statistic does not include the fatality attributed to the Golden Corral restaurant.

¹⁴⁷ As mentioned in Section 4.5.2, 96 percent (or 155 out of 161) of the deaths from the May 22, 2011, Joplin tornado were caused by impact-related injuries. However, this analysis includes 154 deaths since the final location of injury (and death) for the fatality attributed to the Golden Corral restaurant remains uncertain.

Table 4–3. Number of Impact–Related Fatalities By Location (Of Death or Injury That Led To Death) Resulting From The May 22, 2011, Joplin Tornado.

Locations of Injury/Death	Number of Victims	Percentage of Victims
AT&T store	1	0.6 %
Elks Lodge	4	2.6 %
Full Gospel Church	4	2.6 %
Greenbriar Nursing Home	19 ^a	12.3 %
Harmony Heights Baptist Church	3	2.0 %
Home Depot	8	5.2 %
Meadows Healthcare facility	2 ^b	1.3 %
Outside (12 in vehicles)	19	12.3 %
Pizza Hut	5	3.2 %
Residences: apartments	12 ^c	7.8 %
Residences: homes (detached)	59 ^d	38.3 %
Stained Glass Theater	3 ^e	2.0 %
St. John’s Regional Medical Center	12 ^f	7.8 %
Walmart	3	2.0 %
Total	154 ^g	100.0 %

a. Includes one individual whose final cause of death was pneumonia (died June 2011), and five individuals who were injured at Greenbriar Nursing Home, were later transported to a hospital, and subsequently died from tornado injuries.

b. Both persons died at other locations after May 22; one was already weakened by cancer.

c. Includes one person who was injured in an apartment complex and later died in a hospital.

d. Includes 14 individuals who were injured at home and then died later in a hospital.

e. One of these persons was injured at the theater and later died in a hospital.

f. Includes seven victims who were injured at SJRMC, were later transported to another hospital, and subsequently died from tornado injuries.

g. Seven of the 161 deaths attributed to the May 22, 2011, Joplin tornado have been omitted from this analysis for two reasons: 1) the cause of death was by something other than an impact–related factor, and 2) the location of death was unknown.

All 154 deaths in this analysis can thus be traced to impact–related injuries, or more specifically, to being struck by debris during the storm. The immediate causes of death (as documented on the death certificate) ranged from multiple blunt–force trauma to the body (142 deaths) to the following more specific causes: multi–organ failure due to multiple blunt–force trauma to the body (1), fungal infection due to multiple blunt–force trauma to the body (3), internal bleeding due to blunt–force trauma (1), heart failure (and pre–existing heart conditions) and internal bleeding due to being thrown from the hospital bed and hit by debris from the tornado (1), heart attack (and pre–existing conditions) due to being struck by debris from the tornado (3), chronic obstructive pulmonary disease due to blunt–force trauma to the

body (1), pneumonia due to being struck by debris from the storm (1), and end-stage renal disease (and pre-existing conditions) due to blunt-force trauma to the body (1).

To support these data on the 154 fatalities, additional information was obtained from the 71-person sample collected by the CDC as part of its EPI-Aid Study of the May 22, 2011, Joplin tornado.¹⁴⁸ The CDC data related to only a sample of the injured persons included in the original ESSENCE database (see Sec. 4.2 for further explanation). The focus here was on a subset of the injured persons in the CDC sample, namely those who had severe injuries, since it was assumed that these individuals could have died from their injuries without medical care. Thirty-five individuals categorized as severely injured were selected from the CDC sample for use in this analysis of May 22, 2011, Joplin tornado casualties. Persons in the sample whose injury severity was unknown were not selected. The locations where these 35 individuals were severely injured are provided in Table 4-4.

Table 4-4. Distribution of 35 severely injured persons (from the CDC sample) based upon the locations where they were injured in the May 22, 2011, Joplin tornado.

Locations of Injury/Death	Number of Severely Injured in CDC Sample
AT&T store	–
Elks Lodge	–
Places of worship	1
Greenbriar Nursing Home	5
Home Depot	–
Vehicles	8
Pizza Hut	–
Residences: apartments	1
Residences: homes (detached)	18
Stained Glass Theater	1
St. John’s Regional Medical Center	–
Walmart	1
Total	35

The locations of the 154 fatalities and the 35 severely injured persons were plotted and shown in Fig. 4-22, relative to the estimated center track of the tornado (in red). It should be noted that when multiple fatalities or injuries occurred at the same location, ArcGIS plotted only a single icon. Table 4-3 contains

¹⁴⁸ Information from CDC’s injury database, specifically for those injuries categorized in this investigation as severe injuries, was used only as supporting data for the findings observed from the deceased. This was because the CDC dataset, although statistically sampled, was not sampled from a completed ESSENCE database. At the time the ESSENCE database was sampled, it did not contain the 876 total injuries it does currently. Also, the ESSENCE database, since it only contains those who visited hospital emergency rooms in Missouri, does not contain all 1,000 (or more) injuries attributed to this tornado.

data on the numbers of deaths at each location. The map shown in Fig. 4–23 identifies the types of locations where the 154 deaths and 35 severe injuries occurred.

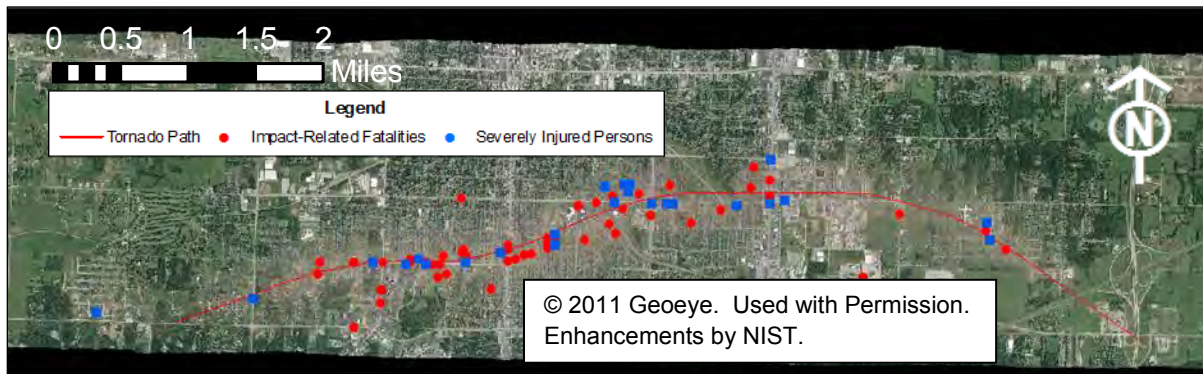

Figure 4–22. Geographic locations of the 154 impact-related fatalities (in red) and 35 severely injured persons (in blue) included in this analysis.

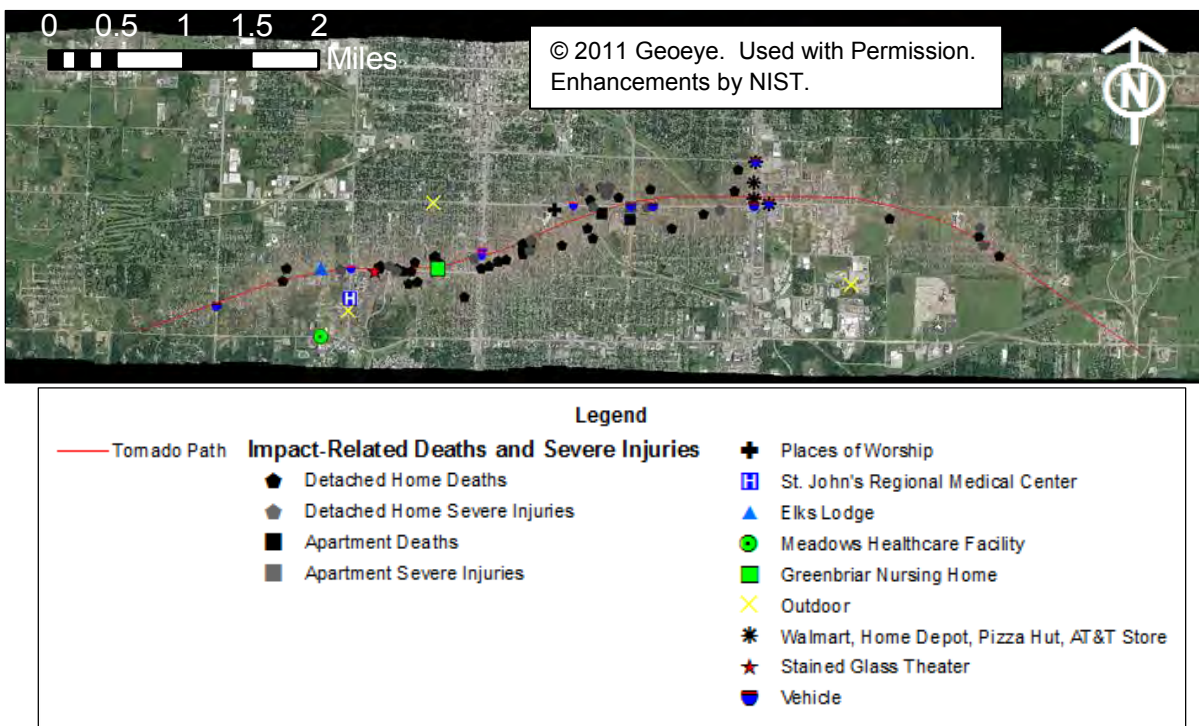

Figure 4–23. Geographic locations (labeled by name of structure or type of setting) of the 154 fatalities and 35 severely injured persons included in the analysis of impact-related deaths and severe injuries.

The analysis of impact–related deaths and severe injuries focuses first on understanding the circumstances of those individuals who died or were severely injured outside of structures. Because they were located outdoors or in vehicles, they were potentially more exposed to the wind and debris environment than those located indoors. Consequently, it is important to understand the wind environment to which these individuals were exposed during this storm. Chapter 2 showed that the tornado produced wind speeds as high as 170 to 175 mph in some locations, but no higher than 65 mph in other locations. Therefore, the first questions addressed were the following: What environmental conditions did the persons who were located outside of structures and killed or severely injured in the storm face throughout the duration of the tornado emergency, and how did these conditions influence their survival?

4.6.1 The Influence of Environmental Conditions on Casualties Outside of Buildings

The outdoor sirens in Joplin were meant to instruct all individuals located outside to move indoors (inside of structures). Additionally, both of the tornado warnings disseminated by the NWS provided the following information on preparedness actions for people located outside of structures:

IF IN MOBILE HOMES OR VEHICLES . . . EVACUATE THEM AND GET INSIDE A SUBSTANTIAL SHELTER. IF NO SHELTER IS AVAILABLE . . . LIE FLAT IN THE NEAREST DITCH OR OTHER LOW SPOT AND COVER YOUR HEAD WITH YOUR HANDS. (See Appendix M)

However, 19 deaths directly attributed to the May 22, 2011, Joplin tornado were of persons located outside of structures or in vehicles when the storm hit. Another eight individuals who were severely injured were also located outside of structures in vehicles when the storm hit them.¹⁴⁹

To understand the environment to which these individuals were exposed, this analysis incorporated the estimations made of the near–surface tornado wind field in the areas where outdoor fatalities and severe injuries occurred. Estimations of the wind–field map were made using multiple methods, including both direct measurements using anemometer records and the indirect measurement techniques of the EF Scale and a Rankine vortex model using observed tree fall, which are further described in Chapter 2.

The near–surface wind field was measured through a series of geographic grid points spaced at regular intervals throughout the areas of Joplin that were affected by the tornado. The distance between grid points was 0.05 miles (264 ft, 80 m), and for each grid point and time step (about every second), a minimum, mean, and maximum wind speed value with associated wind direction was determined. The range of wind speeds is assumed to be representative of the overall uncertainty in the wind speed estimation. The estimated maximum wind speed (including uncertainty measures of minimum and maximum values) at each grid point was rounded to the nearest 5 mph, loaded into ArcGIS, and overlaid with aerial photos. The grid points correspond with latitude and longitude coordinates to give specific locations for the estimated maximum wind speeds (with uncertainty) encountered in the tornado.

The next step in the analysis involved using ArcGIS to relate the locations of fatalities and severe injuries to the near–surface wind–field map. An input file was developed that listed attributes of each outdoor

¹⁴⁹CDC dataset via MDHSS, provided to NIST in 2012.

fatality and severely injured individual, including the location where they were fatally or severely injured. The attributes listed in the input file included the following: physical location when the storm hit (i.e., the physical address), date of death (for fatalities only), and cause of death (for fatalities only).

Once the ArcGIS input file of the fatally and severely injured was developed, it was imported into the *shapefile* containing the estimated maximum wind speed information. In this stage, NIST was able to view the location of all outdoor fatalities and severe injuries along the tornado's damage path.

The next step involved manually drawing polygons to identify those locations along the tornado's damage path where various wind speed ranges occurred. The wind field was used to draw polygons around zones with wind speeds equivalent to the EF-4, EF-3, EF-2, EF-1, and EF-0 ranges. Figure 4-24 shows the five polygons overlaid on the aerial photo of the tornado's estimated center track. In the figure, the red area indicates an EF-4 zone (wind speeds ranged from 166 mph to 200 mph). The orange area denotes an EF-3 zone (wind speeds ranged from 136 mph to 165 mph). The yellow area indicates an EF-2 zone (wind speeds ranged from 111 mph to 135 mph). The green area represents an EF-1 zone (wind speeds ranged from 86 mph to 110 mph). Finally, the blue area denotes an EF-0 zone (wind speeds ranged from 65 mph to 85 mph). ArcGIS was then used to count the number of outdoor fatalities and severe injuries that fell within each polygon.

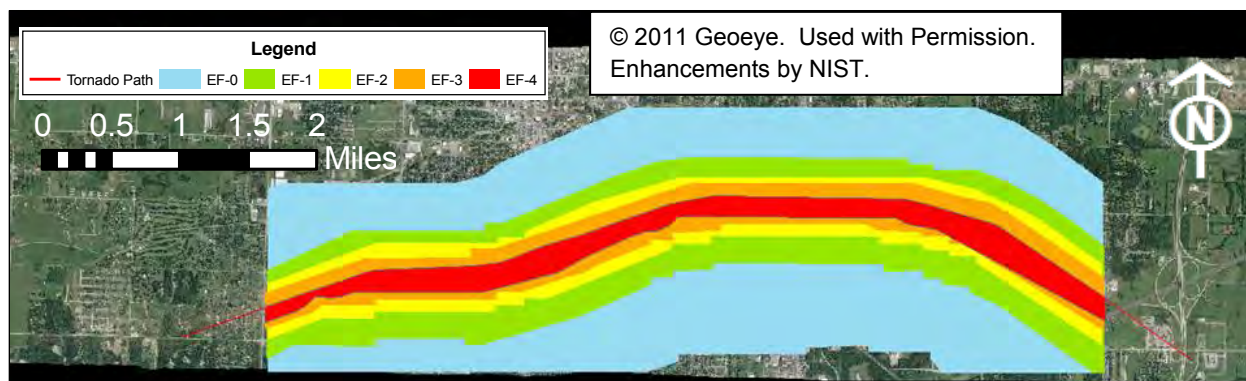

Figure 4-24. The location of the five EF-Scale polygons overlaid on the aerial photo of the estimated tornado center track (red line).

This analysis showed that the majority of the outdoor fatalities (63 percent) and of the sample of severely injured persons (88 percent) was located in the areas where the tornado was estimated to have produced the strongest wind speeds (i.e., EF-3 or EF-4 wind speeds) (see Table 4-5). Fifty-eight percent of fatalities, supported by 88 percent of the sample of severe injuries, occurred in the EF-4 zone.

In the highest estimated wind speed zones (EF-3 through EF-4, where wind speeds ranged from 136 mph to 200 mph), information gathered on the deceased and severely injured reflected individuals being sucked, ejected, or thrown from their cars. Interviews with the severely injured provided detailed information about vehicle windows getting blown out or broken by winds or debris, providing opportunities for the storm to push or pull individuals into the debris field and/or send debris flying into cars, causing severe blunt-force trauma or unconsciousness. This makes it clear how individuals could be

Table 4–5. Wind speeds associated with fatalities and severe injuries among people located outside of buildings.

Wind Speed, mph (EF-Scale)	Number of Fatalities	Frequency	Number of Injuries	Frequency
65–85 (EF-0)	4 (all outside)	0.21	0	0.00
86–110 (EF-1)	2 (1 vehicle, 1 outside)	0.11	1	0.12
111–135 (EF-2)	1 (outside)	0.05	0	0.00
136–165 (EF-3)	1 (vehicle)	0.05	0	0.00
166–200 (EF-4)	11 (10 vehicle, 1 outside)	0.58	7	0.88

killed or severely injured from blunt-force trauma to the body either inside or outside of vehicles. With the exception of one individual located outside of the Greenbriar Nursing Home, all of the fatally and severely injured persons (outside of structures) in the highest estimated wind speed zones were located inside vehicles when the storm hit. This suggests that being caught outside structures and exposed to tornadic wind speeds higher than 165 mph can be very dangerous, due to the tornado's ability to send heavy debris flying into vehicle windows and lift individuals from their vehicles into the storm's debris wall.

Fatalities and severe injuries, although in lower numbers, were also found in zones with estimated wind speeds less than 136 mph. One person was killed outside of the emergency room entrance to SJRMC in an EF-2 zone (where winds were estimated to range from 111 mph to 135 mph). He was thrown from his (outdoor) location and died when a car landed on top of him. Additionally, three individuals died or were severely injured outdoors in an EF-1 zone (winds ranging from 86 mph to 110 mph). One of these individuals (who died) was located outdoors (without any shelter), attempting to catch her dog who had run away from the house. The other two individuals, one of whom died, were located outside of Walmart (Store #59), each located in a pick-up truck. However, because Walmart was such a large structure, according to information provided in Chapter 3, wind speeds varied depending on a person's location in or around the store. Consequently, it was difficult to determine the maximum estimated wind speed to which these individuals were exposed. As shown in Fig. 4–25, the uncollapsed north half experienced a lower maximum wind speed of 120 mph \pm 20 mph (at a northerly wind direction), while the collapsed south half experienced a higher maximum wind speed of 165 mph \pm 20 mph (at a west-northerly wind direction). ArcGIS plotted the store location at one data point, placing all deaths near or around the northern half of the building (i.e., the half that sustained a lower maximum wind speed). However, if the trucks had been located in the parking lot on the west side of the building (see Fig. 4–25), then they could have been exposed to estimated near-surface wind speeds ranging from 85 mph to 135 mph.

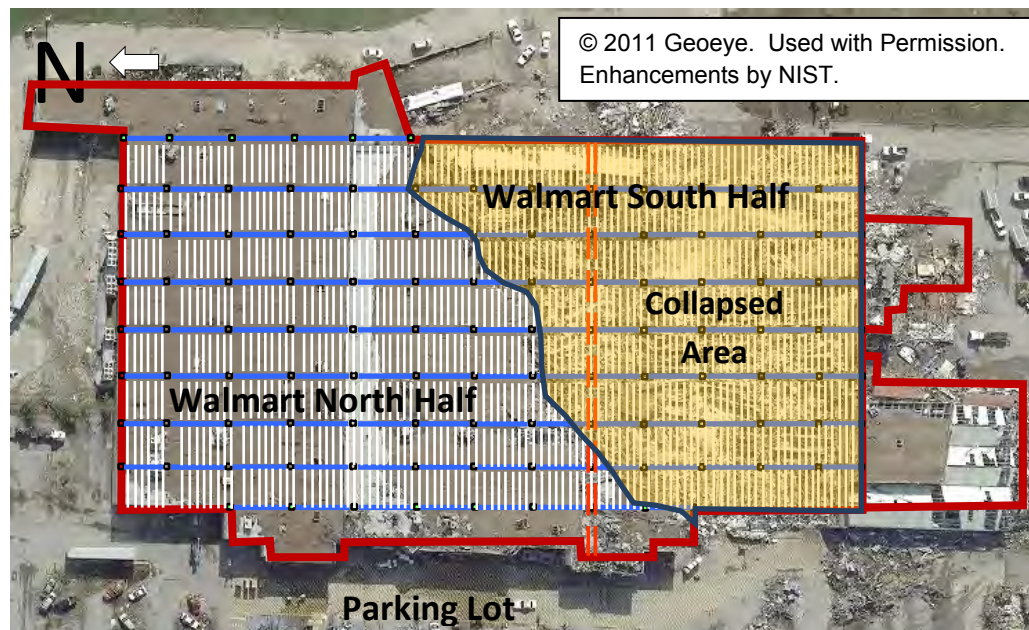

Figure 4–25. Overhead view of tornado damage to Walmart Store #59.

Finally, Table 4–5 shows that four fatalities occurred outdoors in estimated wind speeds between 65 mph and 85 mph. It was of interest to understand where these people were located when the storm hit and why they died in these EF–0 wind speeds. All four persons were located outdoors (and outside of vehicles) when the storm hit. Three of the fatalities were located in a drainage ditch at or near 3877 East 27th Street in Joplin. The cause of these deaths was determined by the Joplin coroner to be blunt–force trauma; however, it is unclear what role, if any, water inside the drainage ditch played in the outcomes. NWS instructions provided in tornadoes state that “If no shelter is available . . . lie flat in the nearest ditch or other low spot and cover your head with your hands” (see Appendix M for further information). However, this ditch did not provide adequate protection for these three individuals, even at a location that was not exposed to the highest wind speeds. Finally, an additional fatality was found at 20th Street and Sergeant Avenue, also outdoors. It is unclear whether the individual was killed at this location by EF–0 wind speeds or if he or she encountered the storm in a nearby location with higher wind speeds (i.e., in an EF–1 zone) and was thrown to 20th Street and Sergeant Avenue.

To summarize this section on casualties outside of buildings, NIST found that overall, the majority of the outdoor fatalities (and severe injuries) occurred in areas subjected to the highest wind speeds. The information presented in the tables and figures above suggests, as expected, that outdoor fatalities and severe injuries markedly increased in the wind zone rated as EF–4 (i.e., in winds greater than 165 mph). At these wind speeds, vehicle windows broke, causing individuals to be ejected from their vehicles or struck by flying debris through broken windows.

The majority of impact–related deaths in the May 22, 2011, Joplin tornado, however, occurred inside structures throughout the tornado’s damage path. Therefore, it is important to understand the types of buildings in which these individuals were located and the protection offered by these buildings, given the tornadic wind environment to which the structures were exposed. The following section examines the environmental conditions, including building performance and wind environment, that persons killed and

severely injured indoors encountered during the tornado, and how these conditions may have influenced their survival.

4.6.2 The Influence of Environmental Conditions on Casualties Inside of Buildings

NWS warning information advises individuals to seek substantial shelter if they are outside or in vehicles. In the May 22, 2011, Joplin tornado, 87 percent of the fatalities attributed to impact-related injuries involved individuals located indoors during the storm. This section addresses the following question: Why did 135 individuals die from impact-related or blunt-force trauma wounds to the body when they were located inside structures throughout Joplin? To answer this question, NIST analyzed the performance of the structures in which people died, the wind environment to which these buildings were exposed, and the actions of the people inside these buildings. Information on wind speeds, building damage, and the actions taken by building occupants will be provided (when known) to assess the level of protection afforded by the building when the tornado struck. As in previous sections, information from the severe injury sample will be used, where possible, to support findings drawn from the fatalities.

To obtain information on wind speeds, ArcGIS was used in conjunction with the estimated wind-field map (described in Sec. 4.6.1, above). All physical locations (i.e., physical addresses) of the buildings in which deaths occurred were queried using ArcGIS. Once each building was located on the aerial map in ArcGIS, the adjacent wind-field estimate (or point) was queried to obtain the mean, minimum, and maximum wind speeds at that point. In instances where a building fell between two wind estimate points, the lower estimates were collected for that building.

Additionally, ArcGIS was used to obtain information on building damage, based on a database created by Pictometry®. The database listed the damage sustained by individual buildings using four main damage categories (light, medium, heavy/totalled, and demolished). These categories were assigned to buildings by analyzing the differences between pre- and post-storm aerial and oblique imagery of the Joplin area.¹⁵⁰ Following are brief descriptions of the levels of damage that characterize each category:

- **Light:** Visible damage to the building envelope, including the loss of a small portion of the roof covering
- **Medium:** Loss of a small portion of the roof system, comprising the loss of some roof covering and structural sheathing and damage to some roof trusses
- **Heavy/Totalled:** Loss of a significant portion of or the entire roof system, thus exposing the building interior to weather damage and compromising the lateral bracing system for walls, but walls remain standing
- **Demolished:** Roof and walls collapsed, entire structure might be shifted off of the foundation and collapsed

When available in the Jasper County GIS database or via NIST analysis documented in Chapter 3, additional information about individual buildings was obtained, including the year built, type of structure,

¹⁵⁰ E. Stitz, Regional Technical Manager – Central Region, Pictometry®. Personal Communication, October 2012.

number of stories, and the presence of an “underground refuge area” (i.e., basement or partial basement) or crawl space. For the most part, this additional building information was available in the GIS database for residential structures only. Figure 4–26 shows an example of the GIS database damage levels distinguished by color.

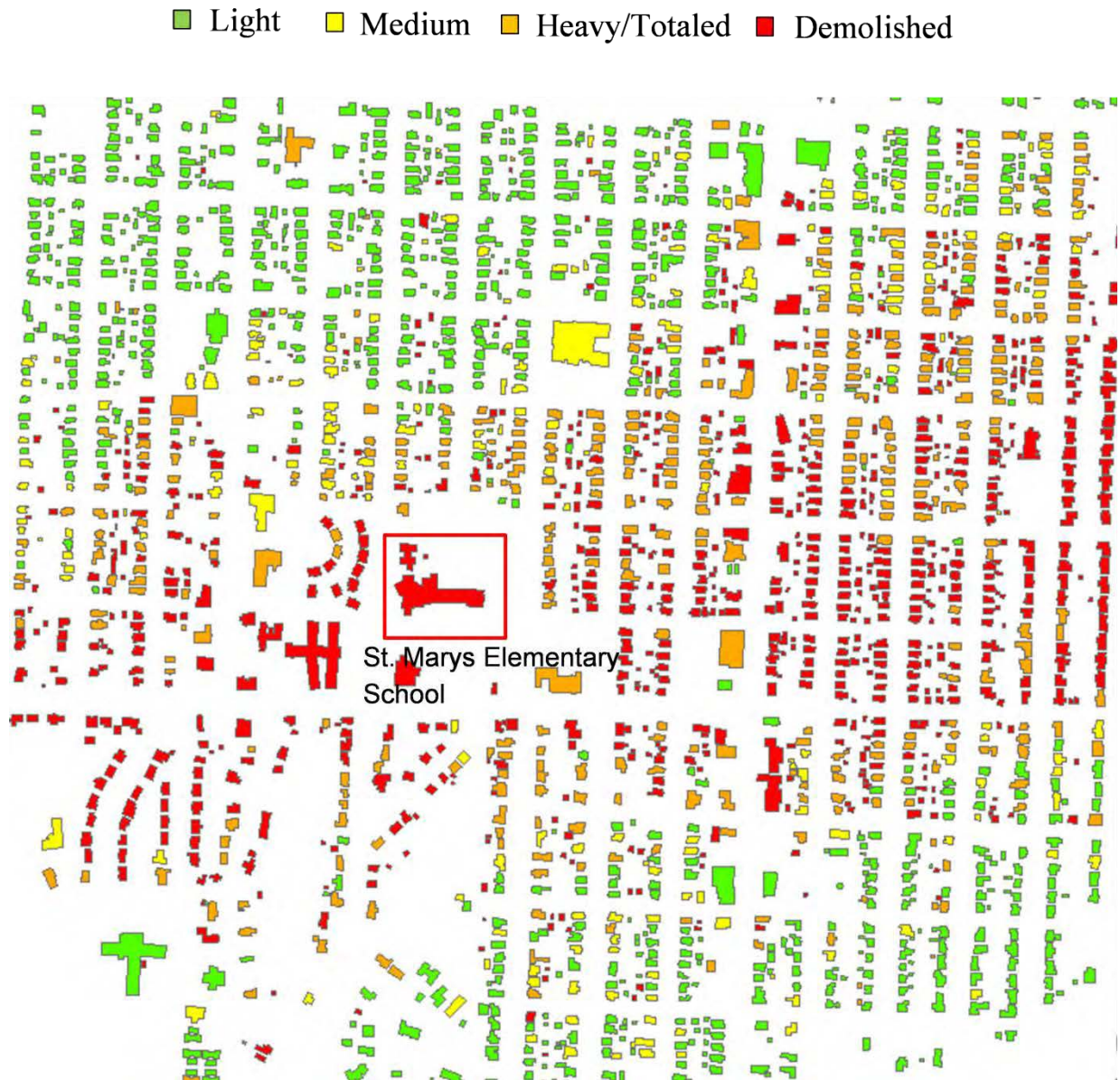

Data Source: Pictometry®. Used with Permission.

Figure 4–26: A sample of the Pictometry® database damage levels distinguished by color.

Finally, for each structure, using the interview narratives referenced in Sec. 4.4, information was collected on where inside the building the decedent(s) took refuge (if known). For example, if a basement was available inside the structure, it was important to know whether the deceased took refuge in the basement or elsewhere. In addition, if the building had a designated “refuge” area, it was important to note whether decedents used these areas.

4.6.2.1 Non-Residential Structures

Table 4–6 presents information on the wind environment, the building type (including building damage), and the actions taken by the deceased (if known) for seven non-residential buildings in which people died. Information concerning Home Depot, Walmart, and SJRMC, also non-residential structures where individuals died but not included in Table 4–6, will be discussed in greater detail later in this section, since they were buildings with more complicated wind speed gradients. These three locations were also discussed in detail in Chapter 3, and some of the information developed for that discussion is used here to provide more comprehensive descriptions of the damage they sustained and its influence on the deceased.

Table 4–6. Details on the wind environment,^a building type, building damage, and actions taken by the deceased for seven buildings in which people died in the May 22, 2011, Joplin tornado.

Building	Wind Speed (avg. max., and range in mph)	Building Type	Building Damage	Basement (Y/N)	Circumstances of the Deceased
AT&T store	160, 115–200	Metal frame walls with brick facade	Unrated	No	Crushed in back office
Elks Lodge	170, 125–210	Wood frame	Demolished	No	Attempting to run to cooler
Full Gospel Church	150, 110–195	Wood frame	Demolished	No	Located in nursery
Harmony Heights Baptist Church	160, 110–195	Concrete masonry unit/wood frame walls with wood roof trusses	Demolished	No	Located in nursery and library
Meadows Healthcare facility	100, 70–135	Wood frame connecting structure; rest of building unknown	Heavy/Totaled ^b	No	(Not known)
Pizza Hut	170, 125–210	Wood frame	Demolished	No	Thrown from cooler
Stained Glass Theater	170, 125–210	Unreinforced masonry walls with brick facade	Demolished	Yes	Above-ground theater area (survivors in basement)

a. Estimated from the wind field model presented in Chapter 2.

b. It is unclear why this building received a “Heavy/Totaled” damage rating since the majority of the roof was intact, except for the small connecting structure on the south end of the building. Additionally, this building was surrounded by other buildings with damage rated as light or medium only.

All seven buildings included in Table 4–6, with the exception of the Meadows Healthcare facility, were exposed to estimated maximum wind speeds of 150 mph \pm 20 mph to 170 mph \pm 20 mph, with the estimated maximum wind speeds ranging from 110 mph \pm 20 mph to 195 mph \pm 20 mph in some cases, and 125 mph \pm 20 mph to 210 mph \pm 20 mph in other cases. The buildings were wood-frame, unreinforced masonry, or metal frame with brick façade structures, and were not required to be built to withstand these levels of wind speed (see Chapter 3, Sections 3.1.4 and 3.1.5, for information on building code requirements related to wind speed, nationally and in Joplin). As a result of the winds to which they were exposed and their building types, six of these seven buildings were categorized as “demolished.” The AT&T store was not rated by the GIS database; however, the picture provided in Fig. 4–27 clearly shows a structure that was “demolished” by the storm.



Figure 4–27. Aerial photo showing the AT&T store demolished by the storm (outlined in red).

In all six buildings classified as demolished, roofs blew off, walls collapsed, and the internal structures of the buildings collapsed. Specifics on each building are provided here based upon visual observations of aerial photos, shown in Fig. 4–27 to 4–32, below.

The first of the buildings in Table 4–6, the AT&T store, sustained complete structural failure with loss of the metal roof decks; disconnection, displacement, and collapse of the entire roof truss system; and complete collapse of all exterior unreinforced CMU walls. In addition, most building components collapsed in place (into all areas of the building interior).

As shown in Fig. 4–28, the Joplin Elks Lodge sustained complete demolition, with disconnection and loss of the entire roof system and complete collapse of the structural wood frame. Similar to the AT&T store, most building components collapsed into the building’s interior due to the storm.



Figure 4–28. Tornado damage to the Joplin Elks Lodge.

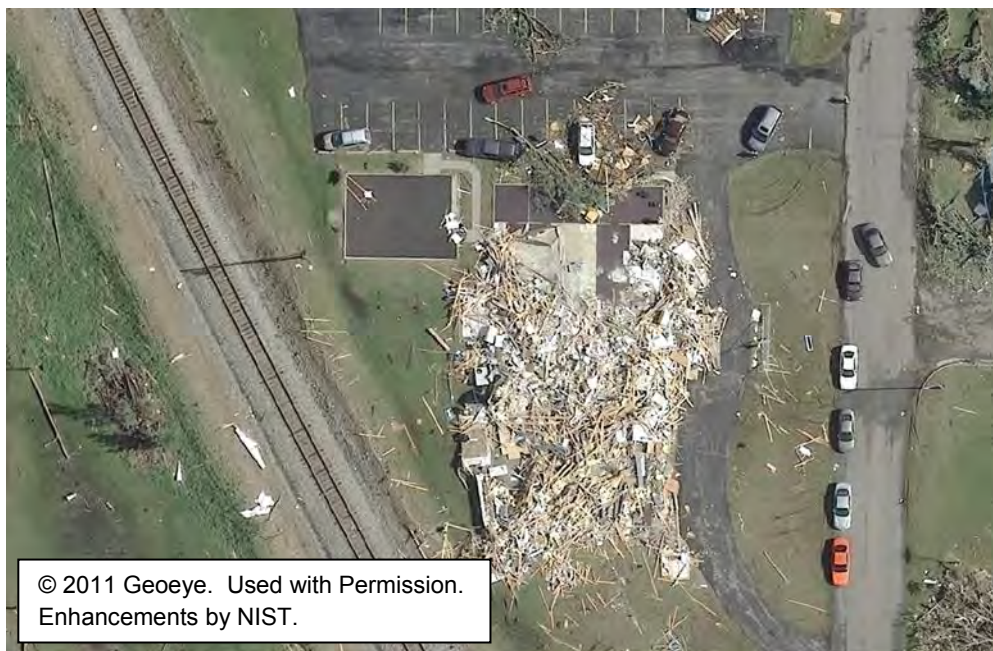

Figure 4–29. Aerial photo showing damage to the Full Gospel Church building.



Figure 4–30. Aerial photo showing damage to Harmony Heights Baptist Church.

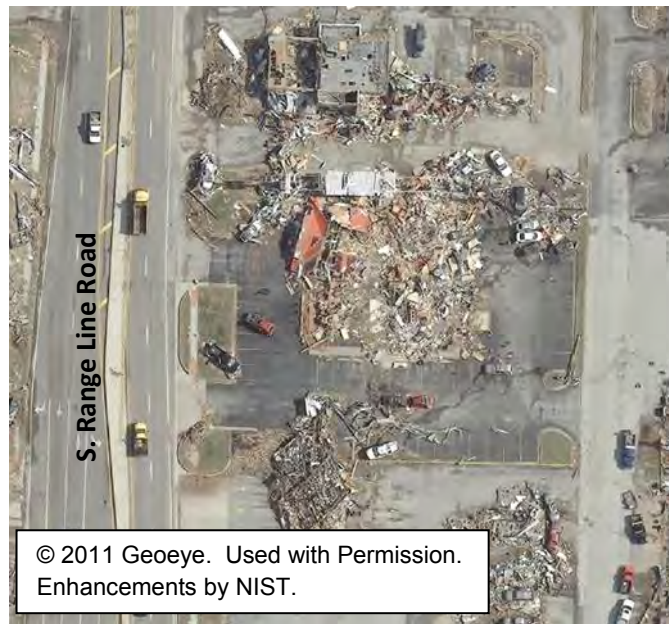

Figure 4–31. Aerial photo showing damage to the Joplin Pizza Hut.



Figure 4–32. Aerial photo showing damage to the Stained Glass Theater.

The Full Gospel Church (Fig. 4–29) was completely demolished, with the entire wood roof system disconnected from the supporting wood–frame walls and disintegrated; and all supporting walls disconnected from the concrete slab foundation and collapsed. Additionally, a significant amount of debris, mostly building materials, ended up in all areas of the building’s interior.

The Harmony Heights Baptist Church was completely demolished by the storm. The building sustained the loss of the entire wood roof system and complete collapse of all exterior CMU/wood frames. Most debris from the roof and walls ended up in all areas of the building’s interior. The damage is shown in Fig. 4–30.

Through observation of aerial photos (Fig. 4–31), it was found that the Joplin Pizza Hut was completely demolished as a result of the tornado. The building’s entire roof system disintegrated and all wood–frame supporting walls collapsed. Also, building materials from collapsed components fell into the interior of the building.

Finally, the Stained Glass Theater sustained complete demolition, with disconnection (and disintegration) of the wood roof system and partial collapse of the exterior CMU walls. Most building materials from damaged building components ended up in all areas of the building interior. Damage to the building can be seen in Fig. 4–32.

The Meadows Healthcare facility was exposed to lower wind speeds than the other buildings in Table 4–6. Even so, the damage to this structure was rated as “heavy/totaled,” and is shown in Fig. 4–33. Two fatalities occurred in this building. One of these two victims had reportedly been ill with cancer prior to the storm.¹⁵¹ It is not known if the other victim was also ill when the storm hit; however, both individuals

¹⁵¹ According to information that NIST found through a LexisNexis® search of obituaries.

died the day after the tornado. One possibility is that the tornado, even at lower wind speeds, caused sufficient damage to the building to cause individuals who were already relatively frail to pass away.

Figure 4–33. Aerial photo showing damage to the Meadows Healthcare facility (outlined in red).

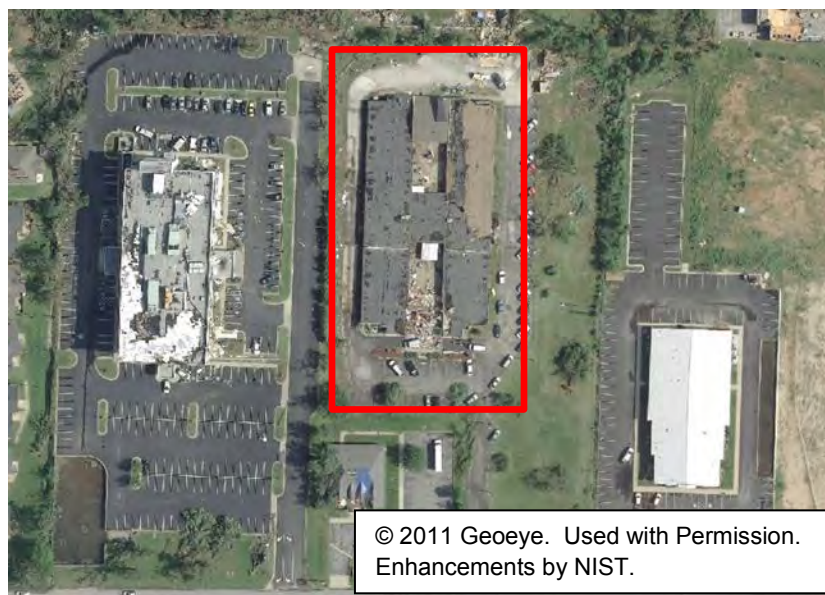

In all of the demolished buildings, the persons killed or severely injured were located above ground. Only one of the eight buildings discussed in this section, the Stained Glass Theater building, contained an underground space or basement that was available to patrons. In that structure, no evidence was found that any of those killed were located in the basement at the time the tornado hit. Additionally, there was one individual in the severely injured sample (provided by the CDC) who was located above ground in the entrance or doorway area of the theater when injured.

In all cases but the Meadows Healthcare facility, the buildings were exposed to wind speeds that resulted in their complete demolition. Victims in these buildings were exposed to flying debris or falling building materials, and in some cases, were sucked from the building out into the storm. At these high wind speeds (i.e., EF–3 and EF–4 zones), the buildings were so severely damaged that the individuals located above ground in these structures were at high risk of blunt–force trauma from the debris field produced by this storm.

Box–Type Structures: Walmart and Home Depot—

Lives were also lost in two larger structures located in the tornado’s damage path. These include a Walmart and a Home Depot.

Walmart

Walmart Store #59 was a one–story, box–type system building with a long–span, flexible–diaphragm metal roof. The building measured approximately 573 ft from north to south and 290 ft from east to west, and the structural system comprised the roof system, a series of individual plane steel frames, and the perimeter walls. For further information on the building’s construction, please see Chapter 3.

On May 22, 2011, the area that people were told to go to for refuge, and where a large number of individuals took refuge (labeled here as the “refuge area”), was located at the back of the store, along the

east wall. Figure 4–34 identifies this area with a red square circled in white. The refuge area was located in the southeastern part of the building, within the collapsed south half of the building that received the higher wind speeds (maximum of 165 mph). As noted in Chapter 3, the refuge area was not a hardened area, but simply an area of the store in which individuals could congregate during a tornado.



Figure 4–34. Aerial photo showing damage to Walmart Store #59, including the red box (circled in white) to indicate the store’s refuge area.

Within the collapsed area, where patrons are known to have congregated during the tornado, the building lost all of its roof decks and joists. Although the majority of the joist girders remained in place, and all columns remained in place, large sections of the leeward concrete masonry walls collapsed inward. The exterior wall of the refuge area was one of the walls that collapsed inward, and it fell into the area where 50 to 60 people had congregated. According to an interviewee, the collapsed wall closest to the refuge area rested on a set of cabinets nearby, creating a D-shaped pocket of safety.

The wind and debris hazard produced by this tornado, as estimated by the wind field model presented in Chapter 2, exceeded the conditions that this store was designed to withstand. In consequence, the Walmart building, specifically the southern half of the building in which many people were located, suffered complete collapse, which can be categorized as “demolished” (similar to most of the buildings discussed in the preceding section). Additional information on the possible failure sequence that led to the building’s collapse can be found in Chapter 3. The store did not have an underground location (or basement) or an indoor storm shelter where patrons could shelter from the storm. The structural collapse of a portion of the Walmart building on May 22, 2011, is thought to have caused three fatalities and an unknown number of injuries among the approximately 200 occupants located inside the building during the storm. However, no official information was found by NIST on the exact location inside the store of the three fatalities.

Home Depot

The Home Depot store was a one-story, box-type system building with a long-span roof. The building had the following approximate dimensions: 470 ft from north to south by 250 ft from east to west, with a mean roof height of 28 ft. The building's structural system comprised the roof system, a series of five individual plane steel frames, and the perimeter tilt-up concrete wall panels. For further information on the building's construction, please see Chapter 3.

The Home Depot's perimeter tilt-up walls and roof system completely collapsed during the tornado. In total, 63 of the 73 wall panels collapsed either inward or outward, leaving 10 standing after the storm. Due to the wind and debris damage it sustained, this building was categorized as "demolished" in the GIS database. An aerial photo of the damage to the Home Depot is shown in Fig. 4-35.

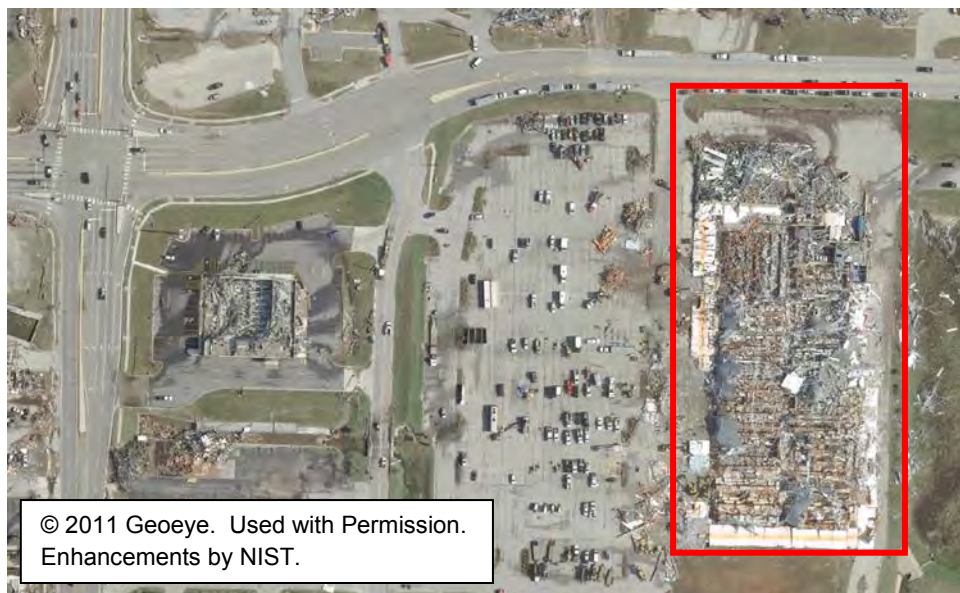

Figure 4-35.
Aerial photo showing damage to the Home Depot (outlined in red).

Media accounts indicated that 35 employees and customers gathered inside the training room at the back of the store before the storm hit. According to the store's emergency procedures, the training room was the designated refuge location in the event of severe weather, such as tornadoes. Death certificates obtained by NIST showed that a total of eight fatalities occurred at the Home Depot; however, interviews with Home Depot survivors reflected that seven deaths occurred inside the structure. According to the interviews, the deaths were likely the result of the structural collapse located toward the front of the store in the lumber area. The number of injuries that resulted from the structural collapse of the Home Depot is unknown.¹⁵²

The wind and debris hazard produced by this tornado, as estimated by the wind field model presented in Chapter 2, exceeded the conditions that this building was designed to withstand. In consequence, the Home Depot suffered a complete collapse. Additional information on the possible failure sequence that led to the building's collapse can be found in Chapter 3. Similar to Walmart, the Home Depot did not

¹⁵² According to interviews with Home Depot corporate and survivors, Home Depot does not know how many people were in the store that afternoon, only that 35 were in the refuge area.

have an underground location (or basement) or an indoor storm shelter where patrons could shelter from the storm.

Critical Facility: St. John’s Regional Medical Center—

As described in Sec. 4.4.2, SJRMC comprised eight buildings situated in north and south complexes. The focus here is on the two towers, West and East, which were part of SJRMC’s north complex, because patients, visitors, and hospital staff were located in these towers on the evening of May 22, 2011.

The West Tower was constructed in 1965 and had a seven-story, cast-in-place reinforced concrete frame with a mean roof height of 86.7 ft. The East Tower was built in 1985 and had a nine-story steel frame with a 109.3 ft mean roof height. The East Tower was connected to the West Tower along the latter building’s entire elevation by a 10-story steel frame structure that housed the elevator shafts serving both towers. This connecting elevator tower was the tallest structure at SJRMC with a 126.8 ft mean roof height. Thus, even though they had independent structural systems, the two towers had a common, connecting interior floor plan. Additional information on the construction of these towers can be found in Chapter 3.

During the tornado, the towers were exposed to an estimated maximum wind speed of 170 mph \pm 20 mph (the EF-4 wind speed range). As mentioned in Chapter 3, the towers primarily sustained damage to their building envelopes and interiors, but did so without structural collapse. The damage to these buildings included the breakage of almost all vertical glass; damage to the roof systems, including the loss of aggregate roof ballast, which became wind-borne debris that further damaged the facility and the surrounding areas (see Chapter 3); damage to the interiors, including the breakage or collapse of interior partitions, suspended ceiling systems, furniture, fixtures, and equipment; damage to sections of gypsum-metal stud walls surrounding the elevator shaft and to the elevator equipment itself; and water and debris infiltration onto the floors. A view of the interior damage can be seen in Fig. 4-36.

Figure 4-36.
Damage to the
interior of
SJRM.



© 2011 Curtis Lynn Geise.
Used with Permission.

Interviewees noted the amount of debris on floors throughout the two towers, mentioning the time it took to free people from under the debris. An interviewee who had been on the 6th floor noted that “a couple of people who had walls on top of them, meaning leaning over them, they were compressed under them. Some people—two of them were underneath one of those 2-inch or inch and a half water mains that I told you about for fire suppression. It was falling right on them; they were gonna be hypothermic pretty quickly so we had to move them. One of those was trapped and it took me probably 15 minutes, 10 minutes, to get her loose” (NIST Interview 6). In the Emergency Room on the ground floor of the hospital, interviewees mentioned water up to their ankles and live wires sparking above them (NIST Interview 2).

In addition to damaging the building envelopes and interiors at SJRMC, the tornado hazards (high wind speeds and wind-borne debris) damaged local EDE facilities, resulting in a region-wide loss of electrical power in Joplin, including loss of the main electrical power supply to SJRMC. The tornado also collapsed SJRMC’s Emergency Generator building that housed the backup power generator and other electrical equipment, which resulted in a total loss of electrical power throughout this critical facility.

Due to the loss of power and the magnitude of the internal damage to the two hospital towers, hospital staff on each floor made individual decisions (without the assistance of hospital-wide evacuation announcements) to evacuate the structures. According to the hospital’s risk manager, it is rare that a hospital requires full evacuation. If only a unit or wing of a hospital requires evacuation, staff will coordinate a horizontal evacuation of patients and visitors to a safer area (or compartment) on the same floor. However, after the tornado on May 22, “the building basically was shut down. Nothing was working inside the building” (NIST Interview 7), requiring a full (vertical) evacuation of the hospital. Eventually, firefighters and hospital staff walked throughout the towers requesting that anyone who had not yet evacuated begin to do so. Due to the loss of power throughout the towers, and thus, the loss of elevators and lighting, hospital staff and others evacuated patients and injured individuals through darkened hallways and down staircases using improvised stretchers (i.e., wheelchairs, hospital doors that had been blown off their hinges, backboards, a device called a Med Sled®, and mattresses). In the dark, staff used flashlights and cell phones for illumination (see Sec. 4.4.2).

All five individuals who died at SJRMC on May 22, 2011, had impact-related causes listed on their death certificates (i.e., multiple blunt-force trauma to the body), and four of the five were patients located in ICUs. The causes of death for these patients were determined by the Joplin coroner to be blunt-force trauma; however, it is unclear what role, if any, their pre-existing conditions or the loss of ICU medical support systems played in these outcomes. One additional patient died on the third floor, but this individual was not in intensive care (NIST Interview 7). His or her death was also due to multiple blunt-force trauma to the body.

In addition to the five patients who succumbed at SJRMC, seven people were injured at the hospital, but died in other health care facilities days, weeks, or months later. These seven deaths were similarly attributed to multiple blunt-force trauma to the body.

Although the buildings at SJRMC were constructed in different phases, the newest building was designed in accordance with the 1990 BOCA NBC, which specified a design wind speed of 85 mph. Even after this speed was adjusted upward due to the hospital’s required functionality as a critical facility, the wind speeds used in designing this and other SJRMC buildings were still significantly less than the wind speeds encountered at SJRMC during this tornado. The exceptionally high tornado wind speed estimated

at SJRMC during the May 22, 2011, tornado, combined with the associated wind-borne debris hazard, presented environmental conditions that well exceeded the conditions planned for in designing the hospital's buildings. These conditions caused the loss of both main and backup power supplies (including interior lighting for the entire facility) and the wind and debris-impact damage to the buildings' interiors. This damage, in turn, led to (a) deaths and severe injuries inside the hospital on May 22, some of which led to deaths days, weeks, or months later, and (b) extremely hazardous conditions during a necessary full building evacuation.

4.6.2.2 Residential Buildings

In addition to the lives lost in non-residential buildings, lives were also lost in residences throughout the Joplin area. This section focuses on the fatalities that occurred in single-family homes and apartment complexes as a result of the May 22, 2011, Joplin tornado. Data from severe injuries that occurred in residences, obtained from the CDC sample of severe injuries, are used to support the findings relating to fatalities.

Table 4-7 presents information on the wind environment, building type, building damage, and protective actions taken by the deceased (if known) for residential buildings throughout the tornado's damage path. Instead of determining wind speed point estimates for each residence, the EF-Scale polygons (discussed in Sec. 4.6.1) were used to identify the numbers of fatalities in single-family homes and apartments that occurred within EF-3 and EF-4 wind speed zones.

Table 4-7. Details on the fatalities, wind environment, building type, building damage, and actions taken by the deceased for residential buildings impacted by the May 22, 2011, Joplin tornado.

Type of Residence and Total Deaths	Deaths by Wind Speed Zone	Building Type	Deaths by Building Damage	Decedents' Access to Basement	Circumstances of the Deceased
Single-family homes (59 deaths)	53 deaths in EF-3 or EF-4 zones (36 in EF-4 zone)	Wood frame	54 in demolished, 5 in heavy/ totaled	56 none, 3 partial	All above ground when storm hit; only 20 known to take internal refuge
Apartments (12 deaths)	12 in EF-3 or EF-4 zones (9 in EF-4 zone)	Wood frame	12 in demolished	12 none	All above ground when storm hit; only 2 known to take internal refuge
Greenbriar Nursing Home (19 deaths)	19 in 170 mph, 125-210 (avg. max. and range in mph)	Unreinforced masonry with wood roof trusses	19 in demolished	19 none	Located in hallway

Single-Family Homes—

NIST found that 59 people died in single-family homes as a result of the tornado. These 59 people died in a total of 51 homes along the damage path, since six sets of 2 people and one set of 3 people were together in the same houses when the tornado hit. A large majority of these 59 deaths (53 out of 59, or 90 percent) occurred in homes that were exposed to wind speeds characteristic of EF-3 or EF-4 wind zones

(i.e., estimated maximum wind speeds ranging from 136 mph \pm 20 mph to 200 mph \pm 20 mph, on average). Of the six remaining deaths, which occurred in lower wind-speed zones, four were in houses that, despite the lower wind speeds, were still judged to have been “demolished.” All 59 fatalities occurred in homes where the building damage was rated as either “heavy/totaled” or “demolished,” with the majority of fatalities (54 out of 59 or 92 percent) occurring in homes rated as “demolished.”

The majority of the single-family homes at which fatalities occurred are thought to have been wood-frame structures. The majority of the fatalities in single-family homes (38 out of 59, or 64 percent) occurred in homes built between the years of 1985 and 1999. Only 5 percent of the fatalities occurred in homes built since 2000, and 31 percent of the fatalities (18 out of 59) occurred in homes built in or before 1950. A majority of the fatalities (50 out of 59, or 85 percent) occurred in one-story homes (ranch style, older conventional style, or new conversion style homes), and the remaining nine fatalities occurred in homes that were one and one-half or two stories in height (older conventional or older multi-family homes¹⁵³).

Only 3 of the 59 persons killed had access to an underground level of the house. In all three of these cases, the home was equipped with a partial basement, and NIST found that at least two of these three individuals did not access their basements before the storm hit. The circumstances of the third death, including the location where he or she took refuge, if any, are unknown.

The findings concerning fatalities in single-family homes are supported by the experiences of the 18 individuals from the CDC sample who were severely injured in such structures. All 18 of these individuals were located in one-story or one-and-one-half-story single-family homes that were rated as “demolished” by the storm. Additionally, none of these individuals had homes equipped with partial or full basements. For the severely injured in this sample, homes were built as early as 1910 and as late as 2005.

However, there were people who survived in single-family homes located within the EF-4 wind zone. NIST spoke with 27 such individuals. Of these 27, 11 took shelter in basements (full or partial, located in newer homes). Just one of the 27 interviewees sheltered in a crawl space; as noted earlier in the chapter, the use of crawl spaces was rare in the May 22, 2011, Joplin tornado, even though a large number of the damaged homes within the tornado’s path were equipped with them (80 percent). The rest of the 27 individuals (total of 15) survived while located in internal spaces on the first floor of their home, including in internal closets or laundry areas (3 people), internal hallways (5 people), or internal bathrooms (7 people). Half of these 15 people, who took refuge in internal, first-floor spaces, specifically noted that the building damage provided some type of protection for them from the storm (i.e., the building wall fell down and provided a tent-like structure over them). Two others who sought internal, first-floor refuges suffered severe injuries in the storm.

In sum, people did survive in their homes within areas subjected to EF-4 or higher wind speeds. Additionally, not all of these survivors were located underground during the storm. However, interviewees who were above ground in these wind speed zones mentioned suffering severe injuries or being unintentionally protected by the building damage around them.

¹⁵³ These are characterized as single-family homes because they were not apartment complexes. The term “multi-family home” is meant to describe a semi-detached home where two single-family homes share one “party” wall.

Apartment Complexes—

NIST found that 12 people died in three different apartment complexes as a result of the tornado. These three sites included three-story garden-style apartments located at 2001 Connecticut Avenue (identified by the solid red line in Fig. 4–37), two-story garden-style apartments located at 2034 Connecticut Avenue (outlined by the red, dashed line in the same figure), and two-story garden-style apartments located at 2020 Hampshire Terrace (shown in Fig. 4–38). At all three sites, occupants were exposed to wind speeds characteristic of EF–3 or EF–4 wind zones (i.e., estimated maximum wind speeds ranging from 136 mph to 200 mph, on average). All 12 fatalities occurred in apartment complexes that were rated as “demolished.” These complexes were primarily wood-frame structures, and were not equipped with underground or aboveground protection areas. Consequently, all of those killed were located above ground when the storm hit, and at least one was known to be located inside his apartment (floor level unknown).



Figure 4–37. Aerial photo showing damage to two apartment complexes in Joplin at 2001 Connecticut Avenue (outlined by solid red line) and 2034 Connecticut Avenue (within dotted line).

The findings regarding fatalities in apartment complexes were supported by the one severely injured individual (from the CDC sample) who was injured in the apartments at 2001 Connecticut Avenue.

Along with its tornado warnings for the Joplin area, issued at 5:09 p.m. and 5:17 p.m. on May 22, 2011, the NWS provided the following preparedness information for people located indoors:



Figure 4–38. Aerial photo showing damage to the Hampshire Terrace apartments.

THE SAFEST PLACE TO BE DURING A TORNADO IS IN A BASEMENT. GET UNDER A WORKBENCH OR OTHER PIECE OF STURDY FURNITURE. IF NO BASEMENT IS AVAILABLE . . . SEEK SHELTER ON THE LOWEST FLOOR OF THE BUILDING IN AN INTERIOR HALLWAY OR ROOM SUCH AS A CLOSET. USE BLANKETS OR PILLOWS TO COVER YOUR BODY AND ALWAYS STAY AWAY FROM WINDOWS. (See Appendix M)

Because residential basements were scarce in Joplin,¹⁵⁴ it was important to understand whether any of those who were fatally or severely injured in homes or apartments sought shelter on the lowest floor of the building in an interior room or hallway. Data collected on the fatalities in single-family homes and apartments showed that 20 of the 71 individuals were known to have taken refuge on the lowest floor of the building *and* in an internal location (the locations of 41 individuals were unknown¹⁵⁵). Data collected on those severely injured in single-family homes and apartments showed that 12 of the 19 individuals were known to have taken refuge in internal locations on the lowest floor (2 individuals' locations were unknown). What these findings show is that some individuals in residential facilities, both inside and outside of internal (first-floor) shelters, were severely injured or killed in this tornado.

¹⁵⁴ Only three of the 71 individuals who died in residences in the Joplin tornado had access to basements. Two of these three individuals did not take refuge in the basement before the storm hit, and the other individual's location within the home is unknown.

¹⁵⁵ The locations of the two fatalities in apartments who took internal refuge (in a bathroom) were counted as "unknown" because it is unclear whether they were in a ground-floor apartment.

Greenbriar Nursing Home— Multi-family housing

Nineteen individuals died in the Greenbriar Nursing Home. The structure was exposed to an estimated maximum wind speed of 170 mph \pm 20 mph. The building was an unreinforced masonry structure. Damage to the structure, rated as “demolished”, is shown in Fig. 4–39. It is unclear where the 19 fatalities were located within the Greenbriar; however, there were also five individuals (from the CDC sample) located at the Greenbriar who sustained severe injuries and were located in the hallway, a bedroom, and a doorway inside the structure.



Figure 4–39. Aerial photo showing damage to the Greenbriar Nursing Home.

Both commercial and residential buildings in which people died were demolished or very heavily damaged by this storm. Larger structures, like the Walmart and Home Depot, sustained large areas of damage and collapse, some of which occurred in areas where people were located. Additionally, even though SJRMC’s patient care buildings did not collapse, their interiors were significantly damaged by winds and flying debris and this damage rendered them unusable. May 22, 2011, Joplin tornado fatalities were primarily located in buildings that were exposed to wind speeds within the EF–3 and EF–4 zones. NIST found no evidence that any fatalities occurred to individuals located below grade in this storm.

4.6.3 Summary

Across both indoor and outdoor settings, the majority of the impact-related fatalities (78 percent) and the sample of severe injuries (83 percent) occurred in areas where the tornado produced the strongest wind speeds (i.e., EF–3 or EF–4 wind speed zones). Additionally, 62 percent of fatalities, supported by 74 percent of the sample of severe injuries, occurred in EF–4 zones. The wind speeds in EF–3 zones range

from 136 mph to 165 mph and the wind speeds in EF-4 zones range from 166 mph to 200 mph. Only 8 percent of the fatalities and 6 percent of the sample of severe injuries occurred in wind speeds of less than 110 mph. These data are shown below in Table 4-8.

Table 4-8. Wind speeds associated with impact-related fatalities and severe injuries – all locations.

Wind Speed Range (mph)	Number of Fatalities	Frequency	Number of Injuries	Frequency
65-85	4	0.03	0	0.00
86-110	8	0.05	2	0.06
111-135	22	0.14	4	0.11
136-165	25	0.16	3	0.09
166-200	95	0.62	26	0.74

Table 4-9 shows that the majority of persons who suffered fatal or severe impact-related injuries in this tornado (approximately 77 percent of the fatalities and the sample of those severely injured) were located within 750 ft of the estimated center track of the tornado. “Within 750 ft” was chosen as the benchmark for this analysis because in this area the value for distance/*RMW* (i.e., distance from the tornado center¹⁵⁶ normalized by the average radius of maximum wind (about 0.16 miles, or 850 ft, or 260 m)) was less than one. Values for “distance/*RMW*” of less than or equal to one identify the areas in which individuals experienced the strongest winds.¹⁵⁷

There were fatalities that occurred over 2,500 ft away from the estimated center track of the tornado. All three such fatalities (described earlier) occurred at 3877 East 27th Street in Joplin, outside in a drainage ditch. It is unclear if these individuals died from drowning or impact-related injuries.

Overall, however, the majority of fatalities (and severe injuries) occurred in the areas that experienced the highest wind speeds. The information presented in the tables and in Fig. 4-40 suggests that the fatalities markedly increased at wind speeds of EF-3 or EF-4. The May 22, 2011, Joplin tornado demonstrated that being closer to the center of a strong to violent (EF-3 to EF-5) tornado is associated with experiencing higher wind speeds and a higher chance of fatal injury, even inside structures. The high fatality count observed in Joplin in these wind speed areas accentuates the need to consider ways of further protecting life-safety in tornado-prone regions.

The environmental conditions to which the deceased were exposed during the tornado have been presented. The tornado produced winds that exceeded the design parameters used for many of the buildings within Joplin, and these winds posed risks for people regardless of whether they were indoors, in vehicles, or outdoors without any protection. Additionally, within the Joplin area, individuals had no access to public, FEMA-approved tornado shelters and very little access to underground locations or

¹⁵⁶ Distance from the tornado center as estimated by tree fall.

¹⁵⁷ *RMW* was smaller in the early stages of the tornado, but a “global tornado average” *RMW* was used here to make comparisons.

Table 4–9. Impact–related fatalities and severe injuries by distance from the estimated tornado center track.

Distance from Center (ft)	Distance/RMW	Number of Fatalities	Frequency	Number of Injuries	Frequency
100	0.12	14	0.09	5	0.14
250	0.29	58	0.37	11	0.31
500	0.59	31	0.20	8	0.23
750	0.88	15	0.10	3	0.09
1,000	1.18	9	0.06	4	0.11
2,500	2.94	24	0.16	3	0.09
5,280	6.21	3	0.02	1	0.03

Key: *RMW*, radius of maximum wind.

indoor storm shelters, either in homes or in commercial buildings. However, residents and visitors throughout the Joplin area received close to 20 min of warning lead time to find safety from the storm, as noted by the NWS service assessment of the tornado (NWS 2011). On some occasions in the past, people have evacuated areas predicted to be affected by impending tornadoes (Daley et al. 2005), making it imperative to understand the role that emergency communication and subsequent public response played in the casualties from this storm.

The findings in this chapter reflect that a percentage (12.3 %) of the persons killed by this tornado were caught outside of buildings, and even outside of vehicles, when the storm hit. Additionally, some individuals interviewed by NIST, especially among those who were severely injured by the storm, found themselves actually driving into the path of the storm instead of away from it. Also, some fatalities and severe injuries occurred inside buildings where basements were available but the occupants did not use them for sheltering.

In the following section, one additional question will be considered: Given the relatively generous warning lead time provided by Joplin’s emergency communication system, why did so many casualties occur, especially in places where safer locations were available? To answer this question, it was important to uncover the information that people received before the tornado struck, and the influence that this information had on risk perception and subsequent protective actions.

4.7 THE INFLUENCE OF EMERGENCY COMMUNICATIONS AND PUBLIC RESPONSE ON CASUALTIES BOTH INSIDE AND OUTSIDE OF BUILDINGS

As indicated in Sections 4.6.1 and 4.6.2, the fatally and severely injured, at times, did not reach places that could provide them with the best available protection from the storm. Some individuals were located outdoors or in vehicles when the tornado hit, with some even driving into the path of the storm.

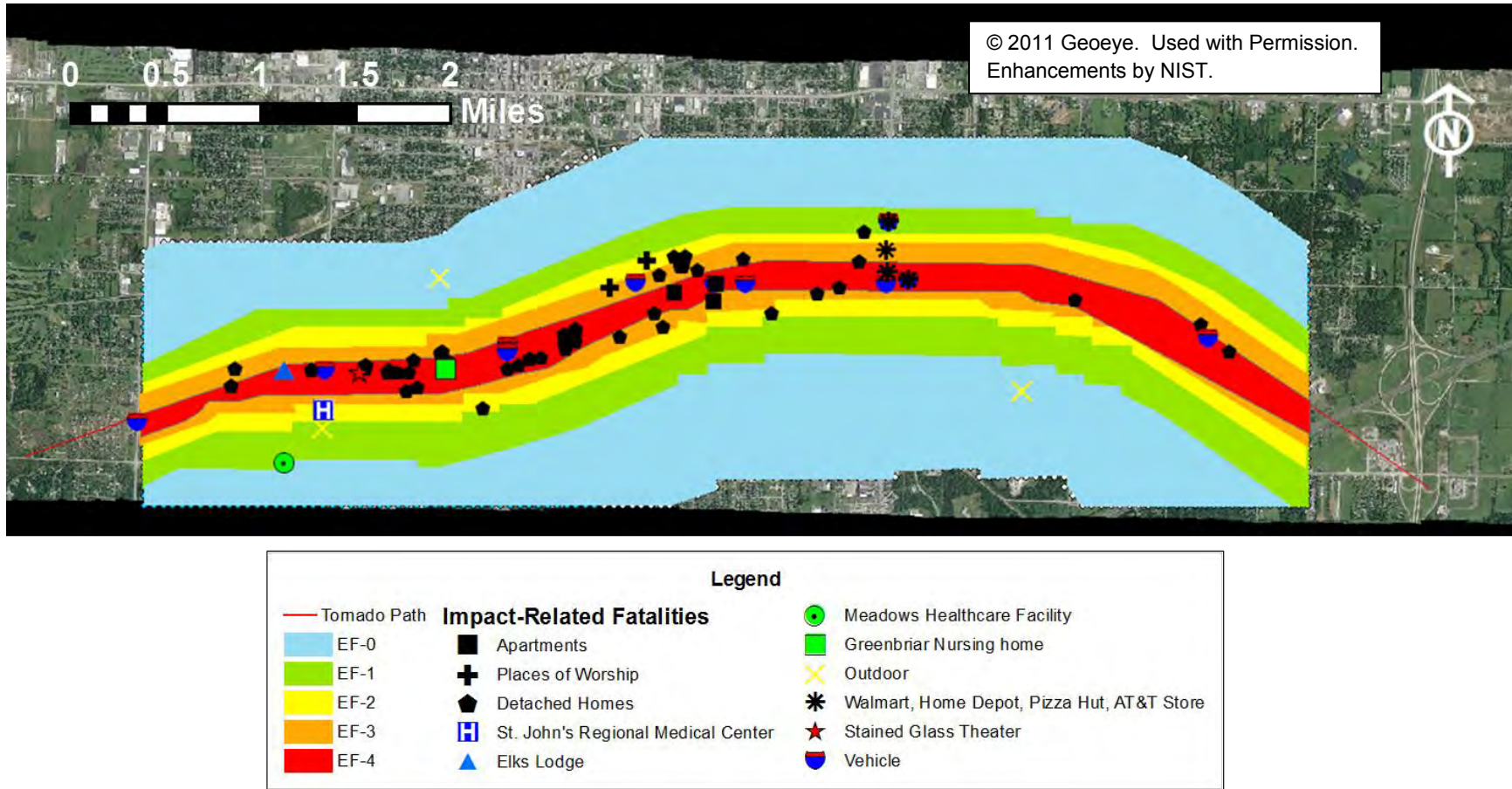

Figure 4–40. Graphic showing the location of all 154 impact-related fatalities in relation to the EF wind speed zones (red = EF-4, orange = EF-3, yellow = EF-2, green = EF-1, and blue = EF-0).

Note: ArcGIS placed SJRMC (hospital) further away than its actual distance from estimated center track of tornado.

Additionally, there were instances in which individuals were located indoors, but refrained from taking refuge in the areas deemed by the NWS to be “safest,” for example, underground basements. Therefore, it is important to determine what influence emergency communications and public response had on the behaviors of these and other individuals who experienced the May 22, 2011, Joplin tornado.

To answer this question, one must understand the motivations behind public response or, as sometimes was the case here, public non-response. Unfortunately, as in any disaster, NIST was unable to discuss with the deceased the emergency information that they received and the subsequent motives or perspectives that guided their actions. Additionally, NIST did not have a complete sample of severely injured individuals, and even for the sample it did have, there was only limited data on the tornado-related information that these individuals received and the actions they took as a result.

However, it is possible to determine the factors that influenced survivors (those injured or not injured) to decide against protective action. Although many interviewees eventually decided to take protective action and made it to a “safer place” (indoors, and in internal refuge areas), a majority of these survivors decided against protective action at some point in their decision-making process. If their rationales can be attributed as well to the deceased, and the authors of this report believe that this is a reasonable assumption, then we can begin to identify possible reasons why additional warning lead time did not necessarily lead to the protection of all individuals in this storm.

NIST analyzed the behavior of a sample of people who experienced and survived the May 22, 2011, Joplin tornado and were subsequently interviewed by NIST for this investigation (n= 165 people). In support of this analysis, NIST also collected data from the over 100 eyewitness accounts found in newspapers and videos. The purpose of the analysis was to develop an evidence-based explanation for why individuals did not take protective action (or seek refuge) between 5:09 p.m. on May 22, 2011, when the first tornado warning was issued for (northern) Joplin or 5:11 p.m., when the first set of sirens sounded throughout the Joplin area, and the time when the tornado hit, which was at about 5:38 p.m. The explanation was also developed to identify the reasons why protective actions were eventually taken by those who took them. The interviews used in developing the explanation were from survivors who were responsible for their own protective decision-making, i.e., those individuals who, at some point during the warning period, had to decide for themselves what to do and when to do it (labeled here as “decision-makers”). “Decision-makers” included, for example, people in homes, in vehicles, outdoors, or traveling from one place to another before the storm hit. This analysis did not include interviewees who had been told by people in authority when and where to take shelter. This analysis also did not include managers or other employees whose role was to instruct others to take shelter (or not), since the sample contained too few individuals in such positions.

For the development of this evidence-based explanation, 140 of the 165 survivors interviewed by NIST were identified as “decision-makers” and included in the analysis. The analysis focused on the information that these interviewees received before the storm, their interpretations of this information, and their subsequent behavioral responses related to seeking protection (or taking refuge in the “safest place” available). A discussion of the methods used to develop the evidence-based explanation is included in Appendix N. A model depicting the explanation is presented in Fig. 4-41.

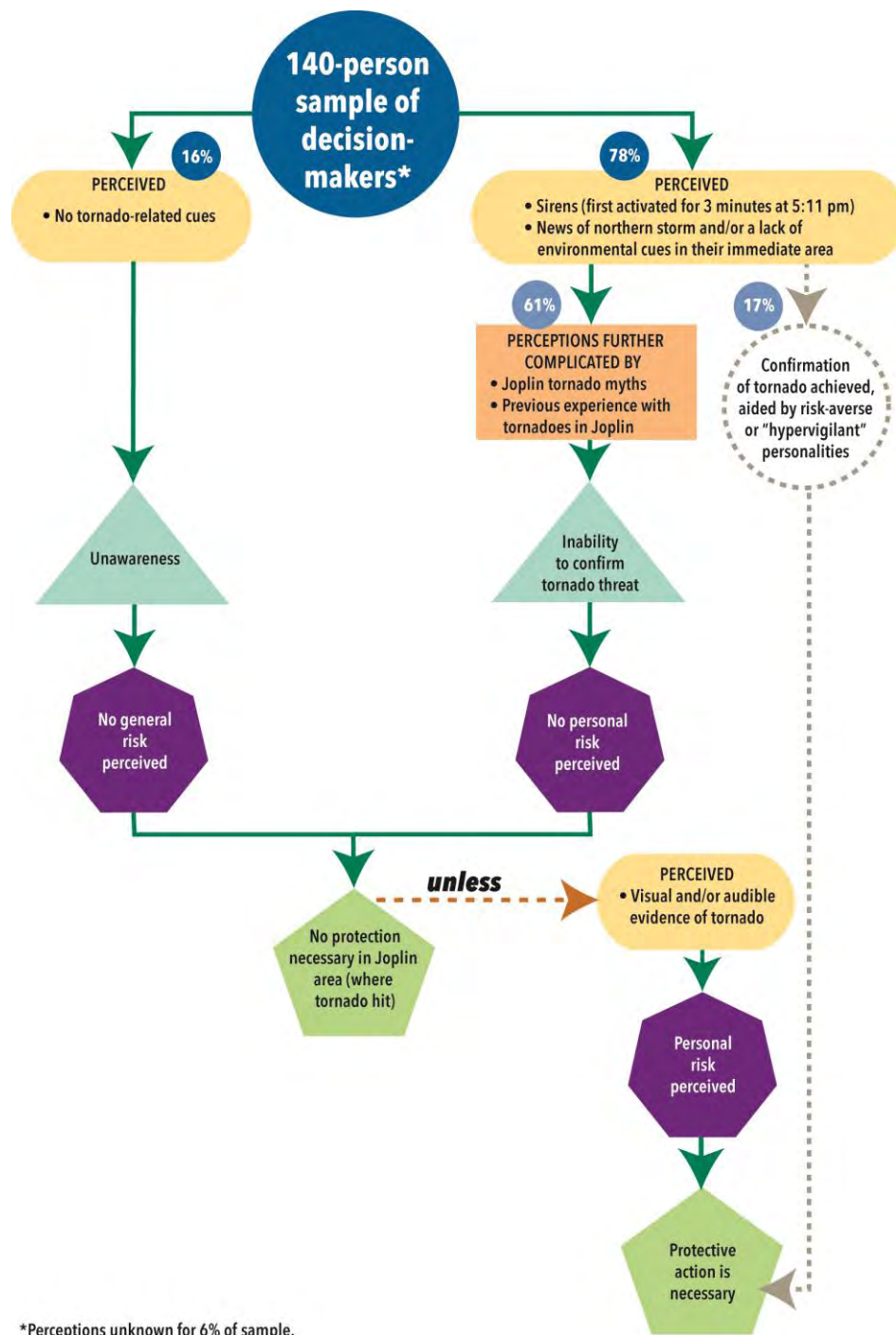

Figure 4–41. A model depicting protective–action decision–making in the May 22, 2011, Joplin tornado.

4.7.1 Protection Is Unnecessary

A majority of decision-makers decided, at some point before the tornado hit, that the act of seeking protection was not necessary. The evidence-based explanation presents two main reasons for this decision: not perceiving any general risk associated with this event and not perceiving personal risk associated with this event. In the first case, individuals who did not receive tornado alert- or warning-related cues on May 22, 2011, i.e., who were unaware that a tornado event was taking place, did not formulate any general risk associated with the event and thus, did not act to protect themselves. Of the 140 survivors included in this analysis, 16 percent were unaware that a tornado event was taking place until a family member or friend called and/or the tornado was upon them. In the second case, individuals who were unable to confirm the existence of a tornado, either due to the receipt of conflicting or uncertain information and/or their pre-existing perspectives on tornadoes in general (formed prior to May 22), did not perceive any personal risk as a result of the weather that day. Of the 140 survivors, a majority of the sample (61 percent) were unable to confirm the existence of a tornadic event until they encountered direct visual or audible evidence of a tornado. Both branches of the model (depicted in Fig. 4-41) are described in the following sections.

4.7.1.1 No General Risk Perceived

There were decision-makers in the Joplin area who refrained from seeking protection because they did not perceive general risk associated with the event. These decision-makers (16 percent of the sample) were unaware that an impending tornado was approaching their location; i.e., they were unable to or did not, for various reasons, receive important information about the tornado. The 16 percent of decision-makers who fell into this category were distributed among three different awareness states that made the receipt of warning information difficult: asleep, awake with impaired hearing, and awake but disconnected from tornado-related emergency communications. In the following discussion, it is assumed that inaction (or decisions against seeking protection) by those who died or were severely injured could have occurred as a result of their being in similar awareness states.

Unawareness of the event could have occurred as a result of hearing impairments. NIST spoke with interviewees who were unaware of the impending tornado due to some type of hearing loss (either permanent or temporary). For example, a couple in their late 80s was watching television before the storm hit, and do not recall receiving any information on the impending tornado. They were both hard of hearing, potentially making it difficult for them to hear outdoor sirens (which others claimed they could hear from indoors) as well as information provided via the television programming that they were already watching. Additionally, extended family members who would normally call and alert them of bad weather were out of town on the evening of May 22. That evening, the wife had noticed that it was getting dark outside. So she went to light candles near the front of the house when the following happened, according to the couple's daughter:

It just hit right then, and everything started flying, and [the husband] threw her [his wife] down in the hallway and just jumped on top of her and held onto the carpet as best he could, and the floorboards. He said when it was over this whole part of the roof was off. (NIST Interview 20)

This couple was caught completely off-guard by this storm, and suffered minor injuries from being thrown around the house.

Being hard-of-hearing or deaf made it more difficult for individuals to receive important information about the May 22, 2011, Joplin tornado. As mentioned in Sec. 4.3, in the Joplin area, weather alerts and warning information were disseminated via the following means: outdoor tornado sirens, television and radio broadcasts, NWRs, and opt-in mobile alerts (sent by local television stations). Joplin-Jasper County's Reverse 9-1-1 system was not used on May 22, 2011. Unless the individual was actively watching a television channel on which weather information was visually provided, or had previously subscribed to mobile alerts (which was not prevalent among NIST-interviewed decision-makers), initial, pre-tornado alert information was likely not received by those with hearing impairments. This is due to the fact that outdoor sirens provided only audible content and the use of NWRs, including visually based NWRs for the hearing-impaired, was not prevalent in the Joplin area.

Unawareness also could have occurred because individuals were sleeping at the time of the tornado, and did not receive important information regarding the May 22, 2011, Joplin tornado. NIST spoke with individuals who slept through the outdoor sirens, and because they were not alerted in any other ways (almost none had a working NWR), they neglected to tune into television, radio, or online resources for further information (NIST Interviews 41, 92, 102). Sleeping individuals were unaware of any risk associated with the event, and thus, did not consciously assign any risk to the impending tornado. At least one death attributed to the tornado was known to have been sleeping (in his apartment) when the storm hit.

Being asleep, especially in the deepest stages of sleep, removes both audible and visual perception opportunities (Gwynne 2007). Unless sleeping residents received alerts sent directly to cell phones that were set to vibrate or ring loudly, or to NWRs that were tuned to a sufficient volume, waking would have proved difficult. Research into fire emergencies has highlighted the difficulty associated with waking individuals from sleep, and the importance of disseminating fire alarm signals at certain volume levels and using certain types of tone patterns (Bruck and Thomas 2007). Statistics have shown that tornadoes that occur at night are more deadly than those that occur during the day, potentially due to the fact that more individuals are sleeping during the former (Simmons and Sutter 2011).

Finally, unawareness could have occurred because individuals were not connected to the necessary modes of emergency communication. In some cases, individuals were out-of-range from the city-wide tornado siren system, and/or simply did not hear the sirens from inside their homes. Even though the siren system was meant to alert individuals located outside of structures only, there was an overwhelming sense among the interviewees that Joplin-area residents located indoors (especially at home) relied on this technology to alert them as well. These decision-makers were also disconnected from other forms of tornado-related emergency communication, such as NWRs or opt-in subscription services that provide messages to mobile phones in the Joplin area. Joplin decision-makers (located at home before the storm hit) who owned an NWR (small percentage of the decision-makers) often admitted that their weather radio device was either not turned on, did not receive the signal, or did not go off (even though it should have) when storm warnings were assigned to their area.

Decision-makers who were unaware of the event often relied on social networks to alert them to impending storms, if they received information at all. For example, NIST spoke with one deaf decision-maker who was located at home within the damage path of the storm. At home with her son, she was

made aware of the storm by receiving a phone call from her mother, who told her to take cover (NIST Interview 69). Additionally, the individuals who were asleep as the tornado approached admitted that they were unaware of the impending tornado until a family member or friend woke them up (either in person or via a telephone call) (NIST Interviews 41, 92, 102).

Some percentage of the decision-makers in this analysis who were unaware of the storm were older individuals (60 years old or above). It was shown earlier that a disproportionate number of older adults (aged 60 or above) died from this tornado (see Figures 4-18 and 4-19). It is plausible to suppose that some of these older decedents could have been hearing impaired, sleeping, and/or disconnected from tornado-related emergency communications when the event occurred, and/or without a social network, and as a result, died from this storm. When focused only on those individuals who died of impact-related causes (total 154), the data still showed that a disproportionately large number of older individuals (above the age of 60) died as a result of this storm (see Fig. 4-42).

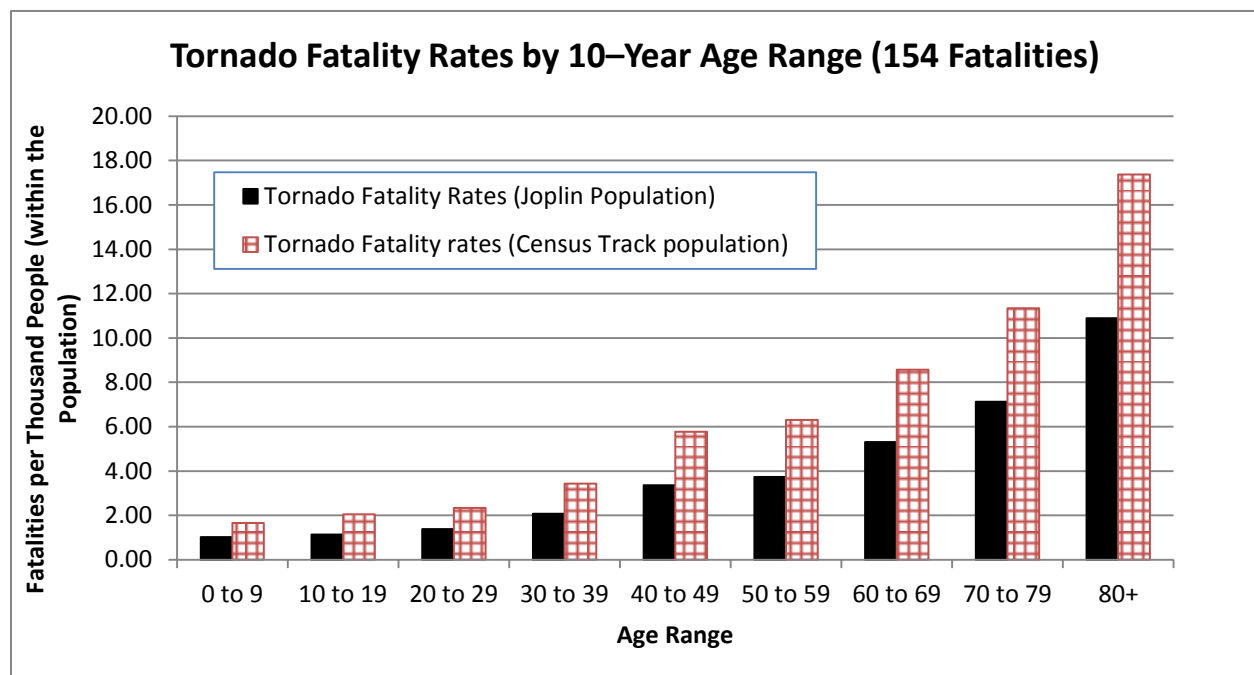

Source: U.S. Census Bureau 2010.

Figure 4-42. Tornado fatality rates per thousand people within two populations: Population 1 – the entire population of Joplin and Population 2 – the population of the areas within Joplin most affected by the tornado (154 impact-related deaths)

It is difficult to determine why older individuals were disproportionately represented among the deaths from the May 22, 2011, Joplin tornado. Even after removing those deaths that occurred in SJRMC and the two nursing homes, which were locations where one would expect older people to be overrepresented in comparison to their presence in the population, individuals 60 years old or older were still overrepresented among the remaining May 22, 2011, Joplin tornado fatalities (see Fig. 4-43 that includes the fatality rates for those located and who died in single-family homes and apartments).

An issue is whether these older persons were fatally injured in internal refuge locations (i.e., they were aware of the storm and died even after taking protective actions) or whether they were caught off-guard by the storm and could not reach a safer location in time. Unfortunately, information on refuge locations could not be obtained for all of the 154 impact-related deaths, possibly because many of the older adults who died in residential locations were alone at the time the tornado hit. Also, there is no way to determine if the older decedents suffered from hearing impairments or any other illnesses or physical limitations that would hinder their ability to take shelter in a timely manner or their ability to physically endure the types of injuries that EF-3 and EF-4 wind and debris environments can inflict.

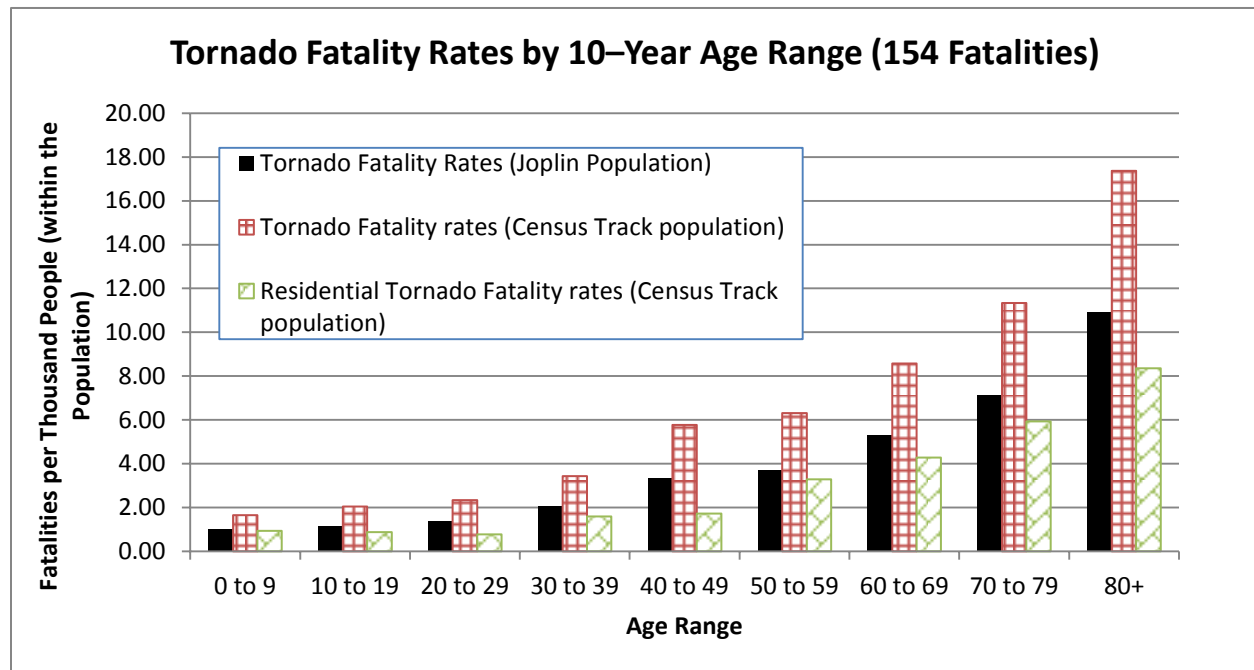

Source: U.S. Census Bureau 2010.

Figure 4-43. Tornado fatality rates (154 impact-related fatalities) and Residential tornado fatality rates (single-family homes and apartments, only)

4.7.1.2 No Personal Risk Perceived (“It Will Not Happen to Me”)

The second branch of the model (Fig. 4-41) shows that there were decision-makers who decided against seeking protection within the Joplin area because they did not perceive personal risk. These decision-makers (61 percent of the sample) were unable to confirm the existence of a tornado and thereby to perceive personal risk, because they received conflicting or uncertain information early on in the warning process, which was further complicated by their own pre-existing perspectives on tornadoes in general (formed prior to May 22, 2011).

When initial information was given to decision-makers on May 22, 2011, around 5:09 p.m., including the sirens that sounded at 5:11 p.m., there was little information available that would help confirm the risk of a tornado threatening the large portion of Joplin that was actually hit around 5:41 p.m. Any warning information provided to individuals around 5:09 p.m. (until 5:17 p.m.) related to a storm that weather

forecasters were tracking to the north of Joplin, which was heading toward Webb City, Missouri, or Carl Junction, Missouri (Tornado Warning Polygon 30). A Joplin native remembered that

the announcer and the weatherman that came on the TV seemed to say the track was, you know, mainly north of town. It wasn't going to be a bother for where I was at towards the south part of town. So, I continued to sit there on the front porch and enjoy the cool air that was, you know, for the day. (NIST Interview 58)

Another interviewee tuned his television to the Weather Channel to view the forecast after hearing the sirens sound. According to him, the storm “looked like it was even way up north, like Pittsburg. I said, ‘That’s not gonna come down and get us.’ So I just kind of ate my food there and was watching [the television]” (NIST Interview 94). After hearing this information and based upon the perceived tendency for storms to track toward the northeast only, interviewees formulated that they were not at risk.

Around this same time, individuals were offered very little in the way of environmental cues of an impending storm, also making it difficult to confirm the tornado risk. People looked outside, to the sky, for clues that a tornado was coming and saw only clouds that did not look as menacing as what would accompany a tornado. An interviewee recalled his actions at home that evening:

The tornado sirens went off once, we walked outside and you couldn’t really, didn’t really see nothing then, and we went back in and finished eating. (NIST Interview 108)

The decision had become as simple as that—if there was nothing in the sky to worry about, then it was appropriate to return to your previous pursuits until something else caught your attention. Some people continued to monitor the weather reports, while others resumed activities unrelated to the weather.

As the first set of sirens stopped and time progressed, interviewees who continued to monitor the weather via television or radio (or Internet sources) still did not perceive firm confirmation of an impending storm likely to affect them. First, the NWS issued a tornado warning at 5:17 p.m. for the storm that eventually hit Joplin; however, the outdoor siren system was not reactivated at 5:17 p.m., likely because Joplin’s emergency manager had already sounded the sirens 6 min earlier (for the northeastern Joplin storm that did not materialize). Additionally, interviewees who had been tuned into the news outlets at 5:17 p.m. primarily reported that the media continued to discuss a storm that was to the north of Joplin. Decision-makers recalled hearing that the storm would miss them, since it was “going around Galena” (NIST Interview 23), passing to the north (NIST Interview 33), or simply moving away from them (NIST Interview 36). Others recalled announcers continually discussing a tornado between Carl Junction and Webb City (NIST Interview 60) or news of a tornado that had hit a small town in Kansas (NIST Interviews 47, 58). Meanwhile, broadcasters for a news-based radio station disseminated via several channels throughout the Joplin area were discussing the potential for winds, power outages, and large-sized hail, with no confirmed reports of a tornado on the ground until 5:40:44 p.m., 3 min after the tornado entered Joplin, when the emergency manager for Joplin–Jasper County was contacted by the station and interviewed about the location of the storm. This broadcast then informed listeners that a

tornado was on the ground at approximately 7th Street and Schifferdecker Avenue¹⁵⁸ or 7th Street and Range Line Road, and it was pushing to the east or slightly southeast; however, both locations turned out to be inaccurate regarding the tornado's path (KZRG 2011). Interviewees who had decided not to continue monitoring the weather reports (e.g., NIST Interview 27) simply turned the television or radio completely off or tuned into another station that was not necessarily issuing weather updates.

For most of the interviewees, certain storm-related cues eventually captured their attention again. When television and radio stations mentioned that a tornado was on the ground, people took notice. Interviewees remembered hearing information about a tornado at Iron Gates, which was located in Joplin. One television station, equipped with a tower cam, was remembered for showing video footage of the imminent tornado (which looked more like a wall of debris than a funnel) and the damage it was producing on its way to Joplin. News announcers on this station pleaded with listeners to "Take cover now!" (KSNF 2011). But by this time, the tornado was minutes or even seconds away from listeners in Joplin.

For those looking to confirm their personal risk by seeing an approaching funnel-shaped cloud, the opportunity never came. The tornado was wrapped in rain and a wall of debris, and was made even more difficult to decipher by Joplin's city-based landscape. As a result, there were individuals caught in their cars driving into the storm, or outside of their cars, as the tornado bore down upon them. It was not until the wind was whipping so hard and the debris was so thick that they could not see, that those driving actually stopped and waited out the storm inside their vehicles. Before this moment, they were not sure that a tornado was actually going to hit them.

There were also individuals located in their homes, but outside of the internal sheltering locations suggested as safer by the NWS. Very little information was available with which these people could confirm imminent risk from a tornado, until people heard what was characterized by many as the sound of a freight train increasing in volume, or saw the wind bending large trees to the ground, for example. Unfortunately for some, they had waited too long to take shelter in a safer place. The tornado was already upon them, ripping the structure apart, before they had time to reach an internal or underground shelter, if one were available to them.

This inability to confirm personal risk in a timely manner on May 22, 2011, was exacerbated by Joplin-area residents' perspectives on tornadoes in general. When asked about their views on the possibility of severe storms in Joplin, decision-makers in the 140-person sample (and even other NIST interviewees) generally did not believe that tornadoes in Joplin were something that they would witness during their lifetimes.

One factor behind these views was a public perception, which was pervasive among the decision-makers, that false alarms were common in Joplin. As mentioned earlier in the chapter, the false-alarm rate for NWS-issued tornado warnings for the City of Joplin had increased to 92 percent during the period from 2007 to 2011, and interviewees seemed to have noticed this trend. One individual described his perspective on storm warnings as follows:

¹⁵⁸ Both addresses (7th Street and Schifferdecker Avenue and 7th Street and Range Line Road) were located north of the tornado's estimated path.

I grew up in Arkansas and spent a lot of time in Oklahoma, and then Missouri in this area. So, tornado watches are common. But, tornadoes don't always strike, and they're usually small. So, the chances of it truthfully hitting are pretty slim. (NIST Interview 10)

Decision-makers seemed to blame the outdoor siren system for overwarning as well, even though the sirens sounded only once per year, on average, for wind-related events. An interviewee who had lived in Joplin for over 40 years dismissed the credibility of the 5:11 p.m. siren almost immediately on May 22, 2011, since she had often heard sirens in the past that were not followed by severe storms, winds, or tornadoes. She commented as follows:

But the sirens have gone off a lot and they'll go off—they'll stay on for two to five minutes and then it's over and, you know, so you—hear sirens a lot but they never really amounted to much of a storm, so you kinda took the warnings lightly, I guess you could say. (NIST Interview 84)

Similarly, another Joplin native noted that after seeing only clouds in the sky, she did not think much of the sirens; they go off so much, she said, that she did not take them seriously on May 22, 2011 (NIST Interview 102). Overall, interviewees acknowledged that the “zoned” Joplin sirens are required to sound for an area larger than may be affected by a storm. However, the prevailing perception was that the system lacked credibility.

Even if a tornado did materialize, most interviewees erroneously believed that they would be safe inside the city limits of Joplin. Residents were confident that they would be protected from severe storms and tornado damage, and believed that “it cannot happen to us” based upon tornado tracking beliefs or myths. Many believed that tornadoes only track to the northeast, not due east and certainly not south. So, if a tornado was located north of the City of Joplin, as was the case for Tornado Warning Polygon 30, issued around the same time as the first sirens sounded, many were quick to believe that they were safe from that particular storm. Additionally, interviewees believed that severe storms always went around Joplin to the north or the south, creating a mythical “bubble” around their city that protected them from harm. One Joplin resident described the bubble phenomenon as a “magic little V that [the tornado] splits off and goes into one of these directions [i.e., north or south of the city]” (NIST Interview 119). Individuals also relied on the geography of the region to keep the storms away. One interviewee acknowledged that the storm that hit Joplin on May 22, 2011 was a very large, unique storm. He supported his belief that a regular-sized storm would have never hit Joplin with the following reasoning:

The geography of this area is as such that I like our chances. There's a lot of rolling hills and a lot of natural barriers and obstacles for a tornado, if it's on the ground, for it to follow. I'm pretty confident. (NIST Interview 5)

Others looked to the rivers around the Joplin area to provide barriers to tornadoes.

Before May 22, 2011, the thought of tornadoes produced little anxiety among area residents. The occurrence of tornadoes had been perceived as a habitual event. Joplin residents had an overwhelming sense of being “around tornadoes several, several, several times” in their lives (NIST Interview 109). However, the difference between being around tornadoes and being in a tornado was rarely acknowledged. Very few interviewees had actually experienced a tornado that damaged their own city or

town, especially their own houses or commonly frequented businesses. Additionally, tornadoes that had occurred were not perceived as having been very large or damaging. Although nearly all of the local people interviewed by NIST (158 out of a total of 165) identified their homes as being within a tornado-prone region, tornadoes were often described benignly as storms that simply drop from the sky, with little notice, and bounce up and down the plains (NIST Interviews 61, 109). One tornado survivor described his pre-May 22 attitude about storms, which was based on his experiences as a storm watcher:

I was very flippant about the whole thing. I really was 'cause I grew up here. I know the activity of tornadoes. I know how they—they're cute. They hit one house and they jump over and hit the next one. And they're just adorable little funnel things that you see in the distance. (NIST Interview 85)

Also, some interviewees expressed their confusion regarding the tornado siren protocol. As mentioned earlier, the Joplin–Jasper County siren system was activated when any one of the following criteria were met: any kind of tornadic activity or warning, or winds of at least 75 mph. On May 22, 2011, some interviewees were confused about how long the sirens should sound and the reasons why the sirens stopped after 3 min. Additionally, Joplin survivors were unsure why the second siren had been initiated, since this had been perceived by many as never happening in the past. Their interpretations of the second siren ranged from it being a warning for a situation that was more dangerous than before to an “all clear” from danger.

It was difficult for decision-makers to perceive personal risk from an emergency communication system that they perceived as providing conflicting or unclear messages or messages with questionable credibility, especially for people with pre-existing perceptions of emergency communications or tornadoes and/or confusion about emergency communication protocols. In response, decision-makers decided against taking protection, often continuing on with daily activities as if there was little or no impending tornado threat. Until cues intensified, the personal risk was not perceived as being high enough to prompt protective action, which in turn, influenced individuals' decisions to drive their vehicles through town, remain outdoors until they were in winds in excess of 160 mph, or delay seeking protection for so long that the tornado hit before safer locations could be reached.

4.7.2 Protective Action Is Necessary

Eventually, almost all decision-makers decided that protection was necessary at some point before the tornado hit their location. However, just because survivors made the decision to take protective action did not mean that they reached their optimal location before the tornado reached them. For example, some individuals were located in their cars, and simply pulled over to ride out the storm. There were two reasons why individuals decided that protection was necessary in the Joplin storm. The first was that confirmation of the tornado was achieved after the initial warnings were provided (at 5:09 p.m. or 5:11 p.m.). The second was that personal risk was perceived; however, this occurred as the tornado was approaching. Both reasons are discussed in the following sections.

4.7.2.1 Confirmation Is Achieved After Initial Warnings

There is one additional branch on the model (Fig. 4–41) that has not yet been described. For 17 percent of the decision-makers, confirmation of the tornado was achieved when they received the initial set of

warning information (i.e., the first set of sirens and/or the news about a northern storm). These individuals took action to protect themselves and their families based upon the same types of information that a majority of individuals (in this sample) used to decide against action.

The main reason identified for taking “early action” in this tornado was the nature of decision-makers’ personalities and/or pre-existing risk perceptions associated with tornadoes. Two types of personalities are identified here: “risk-averse” decision-makers and “hypervigilant” decision-makers. Risk-averse decision-makers claimed to have sought protection every time they had heard the sirens activated before May 22, 2011. The act of taking refuge had become a habit for them during tornado season, and therefore, based on past experiences, they took refuge as soon as the sirens sounded on May 22. All individuals categorized as “risk averse” (3 out of 140) had a basement available to them; therefore, taking refuge early was not a difficult task and they were able to continue to monitor the situation as time progressed, via television, radio, Internet-based technology, or small basement windows. It was not so much that this group felt at risk from this storm, but more that they were habitually risk averse in tornado-related situations, taking the safest route every time (or almost every time) the sirens sounded.

Decision-makers categorized as “hypervigilant” (7 out of 140) described themselves as generally fearful of tornadoes, although none had actually been through a tornado before. These individuals had been monitoring the weather throughout most of the day on May 22, starting hours before the sirens sounded. Whereas other decision-makers perceived the outdoor siren (or other initial alert) as their first actual tornado warning, “hypervigilant” decision-makers perceived the siren or other initial alerts (even about the northern storm) as confirmation that something serious was actually taking place, which prompted them to take immediate protective action.

Additional decision-makers who achieved confirmation after the receipt of the initial set of warning information recalled that they were tuned into a media source that confirmed that a storm was heading their way. These individuals perceived risk based upon information that they received, earlier on, from media outlets. Although NIST reached out in March 2013 to all media outlets serving the Joplin area about their broadcasts before and during the storm, including the hours before the storm hit, almost all media outlets no longer retained recordings of what they had broadcast during this period. Two television stations (KOAM-TV and KSNF) provided video recordings of their broadcasts from no more than 5 min before the tornado hit, one of which provided the “tornado cam” and pleaded with listeners to “Take cover now!” as the tornado bore down upon the city. The other station, while providing information about the storm’s path, was much less urgent and intense in warning people to take cover. Additionally, Zimmer radio provided its tornado coverage to NIST in 1-hour increments, from 4 p.m. to 5 p.m., 5 p.m. to 6 p.m., and 6 p.m. to 7 p.m. Instead of providing confirming evidence early on in the warning timeline, which can be difficult in tornadoes, these limited datasets support the observation discussed earlier in Sec. 4.7.1.2, that little information confirming the existence of a tornado (on the ground) was provided to viewing or listening audiences until the tornado was minutes or even seconds away. Inaccurate information about the tornado’s location and/or expected path was also provided by multiple media sources before the storm hit.

4.7.2.2 Personal Risk Is Perceived

The majority of decision-makers, who eventually decided that protection was necessary, did so only after receiving intense cues from the environment (shown as the lower branch in Fig. 4-41). Intense cues were

those visibly or audibly disseminated by the tornado. Actually seeing the massive debris wall heading straight for them or hearing the sound of a freight train caused Joplin survivors to perceive risk and that they were potentially in trouble. High-intensity cues also included seeing large trees swirling or laying down on the ground, seeing cars or other heavy objects lift or fly off of the ground, and hearing information about the tornado in an urgent tone (i.e., the newscaster who urgently prompted people to “Take cover now!”). It was at this point when they realized that protection was necessary if they wanted to escape this tornado unharmed. Seeing or hearing these cues prompted individuals to take shelter in various locations in buildings, in vehicles, or outdoors. Among these individuals, the intense cues triggered cognitions about risk and danger to themselves, their friends, and family members. In some cases, the cues were so severe that individuals who were already located in their basements moved to an internal refuge area (closet or bathroom) within their basement.

Because the majority of decision-makers waited until the last moment to take protective action, their sheltering options were often limited and suboptimal. In homes, even though Joplin survivors frequently had access to crawl space refuge areas, they rarely considered these spaces as viable options for this storm due mainly to the time required to access them. This forced individuals without basements or tornado shelters to utilize aboveground bathrooms, closets, and laundry rooms for safety. Additionally, last-minute decisions caused drivers in Joplin to simply pull over and face the massive storm—which often meant getting hammered with debris or even lifted up into the storm (inside or outside of their vehicle), only to crash down again. Some last-minute decision-makers were caught outside of houses and businesses, where they were forced to fight for their lives by holding onto the structure. And, even in some businesses, last-minute decisions left people running to shelter locations as the tornado ripped their building apart.

4.7.2.3 Other Actions During Decision Making

Although not featured in Fig. 4-41, some Joplin survivors engaged in preparatory actions and helping behaviors in lieu of taking immediate refuge from the storm. Many Joplin survivors located at home prepared their shelter areas, themselves/family members, or their pets in some way before the storm hit. It was difficult to identify the factors that led individuals to prepare before sheltering. Individuals who skipped preparation activities decided to take protective action at the moment when the tornado was hitting their house, leaving them with little time to perform preparatory actions even if they had desired to do so. Additionally, a group of Joplin survivors took time to instruct others—loved ones, customers, employees, hospital patients or visitors, or others—to take shelter after they had decided to do so. These individuals often felt in some way responsible for the people around them.

4.7.3 Other Important Factors Related to Casualties

Studies of previous tornadoes have identified risk factors for injuries and deaths due to tornadoes in the United States. Simmons and Sutter (2011) performed an extensive regression analysis of tornadoes that occurred in the United States from 1950 to 2007 to understand the factors that contributed to injuries and fatalities. Their results indicated that risks of fatalities and injuries were heightened when:

- Tornadoes occurred at night, likely because residents were asleep at this time and less likely to receive warnings.

- Tornadoes occurred during fall or winter months, likely due to a lulling effect during these seasons and individuals' failure to recognize the potential for off-season tornadoes.
- People in affected areas were in mobile homes during the tornado. The authors found a disproportionate share of fatalities in mobile homes during less-intense tornadoes (F-1, F-2, and F-3) versus fatalities in permanent homes, which generally occurred in more violent tornadoes.
- The affected area was located in the southeastern part of the United States. The annual tornado rate was found to be negatively correlated with the State casualty index (i.e., rates of fatalities and injuries per million residents), possibly because those States accustomed to tornado events are more likely to be prepared (and thus, less likely to experience casualties). Additionally, the coefficient of variation for the annual tornado count, i.e., how consistent tornado event numbers are from year to year, was positively correlated with the State casualty index, possibly meaning that States that are accustomed to experiencing consistent numbers of tornadoes are more likely to be prepared. Finally, the authors found that the percentage of a State's land covered by forest is positively correlated with the State's casualty index, suggesting that casualties are higher in places where it is more difficult to see approaching tornadoes.

None of these factors was operative in the May 22, 2011, Joplin tornado. Therefore, it is conceivable that the death and injury toll resulting from the May 22, 2011, Joplin tornado could have been even higher if the tornado had occurred, for example, at night and/or in the fall or winter months. The toll also could have been greater if the tornado had targeted other areas within Joplin or beyond that contained mobile home neighborhoods.

Studies have also shown that an additional factor, which was a potential factor in the May 22, 2011, Joplin tornado, has contributed to injuries and fatalities in previous tornadoes (Simmons and Sutter 2011). That factor is warning lead time (or the time between warning dissemination and tornado touchdown). Simmons and Sutter found that a warning lead time of 6 min to 10 min provided the largest reduction in expected fatalities when compared with an unwarned tornado. Overall, warnings with lead times up to 15 min reduce casualties; however, the authors found no additional benefit for warning lead times of 16 min or more.

In the May 22, 2011, Joplin tornado, warning lead times of greater than 17 min occurred. However, the effectiveness of this relatively long lead time appears to have been offset by a number of factors, including the distraction and confusion effected by the northern storm, the failure of the community-based information sources to provide accurate up-to-the minute information, and the lack of early environmental cues, which lead to inaction of residents until the very last minute. This analysis has shown that the wind environment and issues with building performance were also causes of casualties from this storm.

4.8 CHAPTER SUMMARY

The objective of this chapter is to describe the pattern, locations, and causes of the fatalities and injuries attributed to this tornado, and to examine the associated emergency communications and public response. This chapter provides an understanding of the behavior of individuals exposed to the May 22, 2011, Joplin tornado, and of the factors that influenced survival or death, including the protective actions of

affected persons, the performance of affected buildings, and the environmental conditions that the tornado brought to these people and buildings. More attention is given to understanding the deceased population than the injured population due to the sheer number of injuries caused by this storm and the limited information available to NIST on the injured population. The purpose of this portion of the investigation was to identify recommendations relating to emergency communication, building and shelter performance, and public training or education that can improve public safety in future tornadoes.

A total of 161 deaths and more than 1,000 injuries have been attributed to the May 22, 2011, Joplin tornado, a storm that damaged an area with an estimated population of 20,820. To understand the causes of the tragic death toll, NIST interviewed family and friends of the deceased and analyzed information obtained through official death records, obituaries, publications about the storm, and public forums honoring the dead.

This mortality research revealed that of the 161 deaths resulting from this tornado, 155 (96 percent) were caused by impact-related factors (i.e., multiple blunt-force trauma to the body). Others were caused by stress-induced heart attacks, pneumonia, and lightning. Further analysis showed that of the 155 impact-related deaths, 135 (87 percent) were of persons known to have been located indoors during the tornado. The structures in which people died included both residential (59 percent) and non-residential (41 percent) buildings.

It was important to understand why so many fatalities occurred inside of the potentially protective environments provided by buildings. NIST found that virtually all of the buildings in which the 135 indoor, impact-related fatalities occurred experienced maximum estimated winds associated with EF-3 or stronger tornadoes, which exceeded the code-level wind design condition for buildings in the Joplin area. NIST also found that the hospital towers at SJRMC did not provide life-safety for all occupants, even though the tower themselves did not collapse. A total of 12 impact-related fatalities occurred in the hospital; 4 of these victims were ICU patients.

Public response to the impending May 22, 2011, Joplin tornado was found to have been overwhelmingly delayed or incomplete. For the most part, it was not until individuals received high-intensity cues, such as hearing or seeing the tornado approach or witnessing the urgency with which others sought protection, that they took actions to protect themselves. In many cases, this delay resulted in truncated protective actions and suboptimal sheltering, as was evidenced by the fatalities that occurred outdoors and in vehicles, and by the deaths of persons who had been rushing to obtain safer refuge at the moment when the tornado hit. An analysis of the behavior of May 22, 2011, Joplin tornado survivors (who delayed their response to the storm or did not take shelter at all before the storm hit) identified two factors that contributed to the delayed public response: (1) a lack of awareness of the tornado, and (2) an inability to perceive personal risk due to one or more of the following: the receipt of conflicting or uncertain information about the tornado, pre-existing beliefs about tornadoes or Joplin's invulnerability to tornadoes, and distrust of or confusion about Joplin's emergency communication system.

Conflicting and uncertain information was prevalent in this storm. On May 22, 2011, two official tornado warnings were issued within a span of 10 min, the first pertaining to only part of Joplin and the second to the entire city. After the first official warning, the tornado sirens were sounded but no tornado occurred. After the second official warning, 21 min elapsed before the sirens were sounded again as the tornado entered the city. While the outdoor siren system frequently prompted Joplin residents and visitors to seek

further information on May 22, 2011 (i.e., acting as an alert system rather than a warning system), the multiplicity of information sources, and the conflicting information provided by these sources, added to the public's confusion about the true hazard. Additionally, other means of alerting individuals about the storm (i.e., radio, television, EAS, or weather radio) were less effective in prompting response, and the Joplin–Jasper County Reverse 9–1–1 system was not used on May 22, 2011.

Pre-existing beliefs that Joplin was immune to a direct tornado strike and distrust of or confusion about emergency communications were also prevalent in this storm. NIST found evidence of high false-alarm rates in Joplin for NWS-issued tornado warnings, but not for Joplin's outdoor siren system (which had an average activation rate of once per year)—even though citizens perceived high false-alarm rates for both warning sources. NIST found that the roughly 30-square-mile City of Joplin experienced only one tornado rated EF-2 or greater since 1950, while areas surrounding Joplin (within an 80-mile radius) experienced many more, circumstances that may have bolstered local beliefs about the city's immunity to direct tornado strikes. Finally, NIST found that, across the United States, there was no standard method for sounding outdoor public siren systems, resulting in variations in siren usage, activation procedures, and sounding patterns among communities. This lack of standardization could have led to confusion about Joplin's emergency communication system on May 22, 2011, which was exacerbated by the rare occurrence of two siren activations (at 5:11 p.m. and 5:38 p.m.) during the same evening.

Other factors possibly related to the May 22, 2011, Joplin tornado deaths were also identified. One was the lack of basements or underground spaces in the Joplin area. NIST found that no fatalities occurred in single-family homes demolished by the tornado in which people took refuge in basements. Additionally, NIST found no evidence that any of the Joplin fatalities occurred underground. Another factor that emerged was age. NIST found that a disproportionate number of people aged 60 years or older died or were injured as a result of this tornado, even after removing all hospital and nursing home deaths. Potential explanations for this finding include limited information flow to these individuals, a lack of supportive social networks among this group, and greater physical frailty among older individuals.

Finally, although this is not identified as a contributor to deaths or injury in the tornado in this report, the authors would be remiss not to mention the many examples of altruistic behavior identified by survivors of this storm. There were instances identified where individuals laid their own bodies over loved ones to provide shelter from the storm, and in some cases (e.g., the Joplin Elks Lodge), those who were protected survived to tell about their experiences. Disasters in the past have been shown to bring out “the best” in people, and the stories told to NIST by the May 22, 2011, Joplin tornado survivors are no different. The survivors, themselves, became the first responders, both before and after the storm hit Joplin, MO.

4.9 REFERENCES

- Alberta Public Safety Services. 1991. *Tornado—A Report: Edmonton and Strathcona County, July 31, 1987*. Edmonton, Alberta.
- Babb, Kent. 2011. Moises and Arriy Carmona: Building a better life is a task unfinished. *Kansas City Star*. June 20, 2011. Accessed January 2, 2013.
- Belk, Brad. 2010. May tornadoes struck Joplin twice in 1970s. *Joplin Globe*. May 8, 2010. Accessed May 13, 2013.
- Bruck, D. and I. Thomas. 2007. *Waking Effectiveness of Alarms (Auditory, Visual and Tactile) for Adults Who Are Hard of Hearing*. Optimizing Fire Alarm Notification for High Risk Groups Research Project Report. The Fire Protection Research Foundation. Quincy, MA, June.
- Carter, A. O., M. E. Millson, and D. E. Allen. 1989. Epidemiologic study of deaths and injuries due to tornadoes. *American Journal of Epidemiology*, 130, 1209–1218.
- CBSNews. 2011a. Searching for Joplin’s most vulnerable. Accessed October 23, 2012. www.cbsnews.com/video/watch/?id=7367133n.
- CBSNews. 2011b. Frantic search for bedridden Joplin woman, 86. Accessed October 23, 2012. www.cbsnews.com/2100-500202_162-20065617.html.
- CDC (U.S. Centers for Disease Control and Prevention). 1985. Tornado disaster—North Carolina, South Carolina, March 28, 1984. *Morbidity and Mortality Weekly Report*, 34, 205–206, 211–213.
- Coleman, Timothy A., Kevin R. Knupp, James Spann, J. B. Elliott, and Brian E. Peters. 2011. The history (and future) of tornado warning dissemination in the United States. *American Meteorological Society*, May, 567–582.
- Colorado Department of Public Safety. 1991. *Lessons Learned from Limon: A Tornado After-Action Report*. Division of Disaster Emergency Services. Golden, CO.
- CWA (Communications Workers of America). 2011. Everyone was yelling and screaming and crying and praying. CWA Newsletter, June 2, 2011. Accessed December 29, 2012. http://www.cwa-union.org/news/entry/everyone_was_yelling_and_screaming_and_crying_and_praying/.
- Daley, W. Randolph, Sheryll Brown, Pam Archer, Elizabeth Kruger, Fred Jordan, Dahna Batts, and Sue Mallonee. 2005. Risk of tornado-related death and injury in Oklahoma. *American Journal of Epidemiology*, 161(2), May 2, 1999, 1144–1150.
- Drabek, Thomas E. and Keith Boggs. 1968. “Families in Disaster: Reactions and relatives.” *Journal of Marriage and the Family* 30: 443–451.

- Fahy, Rita F. and Guylene Proulx. 1997. Human Behavior in the World Trade Center Evacuation. Pp. 713–724 in *Fire Safety Science — Proceedings of the Fifth International Symposium*, edited by Y. Hasemi. London, UK: Interscience Communications Ltd.
- FEMA (Federal Emergency Management Agency). 1980. *Outdoor Warning Systems Guide*. Washington, DC.
- FEMA (Federal Emergency Management Agency). 2006. *Outdoor Warning Systems Technical Bulletin (Version 2.0)*. Washington, DC.
- Fernandez, L., Byard, D., Lin, C., Benson, S., & Barbera, J. (2002). Frail elderly as disaster victims: emergency management strategies. *Prehospital and Disaster Medicine*, 17(2), 67–74.
- Fothergill, Alice. 1998. The Neglect of Gender in Disaster Work: An overview of the literature. Pp.11–25 in *The Gendered Terrain of Disaster Through Women's Eyes*, edited by E. Enarson and B.H. Morrow. Westport, CT: Praeger Publishers.
- Gershon, Robyn R.M., Kristine A. Qureshi, Marcie S. Rubin, and Victoria H. Raveis. 2007. Factors Associated with High-Rise Evacuation: Qualitative results from the World Trade Center evacuation study. *Prehospital and Disaster Medicine* 22(3): 165–173.
- Gwynne, S. M. V. 2007. *Optimizing Fire Alarm Notification for High Risk Groups*. The Fire Protection Research Foundation. Quincy, MA.
- Hammer, Barbara and Thomas W. Schmidlin. 2002. Response to warnings during the 3 May 2000 Oklahoma City tornado: Reasons and relative injury rates. *Weather and Forecasting*, 17(3), 577–581.
- Hodler, Thomas W. 1982. Residents' preparedness and response to the Kalamazoo tornado. *Disasters*, 6(1), 44–49.
- Joplin Globe*. 2011. *32 Minutes in May: The Joplin Tornado*. Pediment Publishing. Canada.
- Kansas City Star*. 2011. *Joplin 5:41*. Kansas City Star Books. Kansas City, MO.
- Knapp, Dave and C. F. Boone. 1971. *The Joplin Tornado*. Boone Publications. Accessed in 2011 via www.kspr.com/news/local/kspr-joplin-mo-tornado-pictures-of-may-5-1971-tornado-that-struck-joplin-mo-20110531,0,2771576.photogallery.
- KSHB. 2011. Joplin Pizza Hut employee: Hero manager saved our lives in tornado. Accessed January 31, 2013. www.kshb.com/dpp/news/state/missouri/Joplin-Pizza-Hut-employee-Hero-manager-saved-our-lives-in-tornado.
- KSNF. 2011. Tornado Coverage Video. Nexstar Broadcasting, Inc. May 22.
- KZRG. 2011. Breaking Weather Update. Zimmer Radio, Inc. May 22.

- Kuligowski, Erica D. 2013. Model Building: An examination of the pre-evacuation period of the 2001 World Trade Center disaster. *Fire and Materials*, in press.
- Kuligowski, Erica D. 2011. *Terror Defeated: Occupant Sensemaking, Decision-making and Protective Action in The 2001 World Trade Center Disaster*, PhD Thesis, University of Colorado.
- Kuligowski, Erica D. and Dennis S. Mileti. 2009. Modeling Pre-evacuation Delay by Occupants in World Trade Center Towers 1 and 2 on September 11, 2001. *Fire Safety Journal*, 44(4), 487–496.
- Lillibridge, Scott R. 1997. Tornadoes. In *The Public Health Consequences of Natural Disasters*. Oxford University Press. New York, NY, 228–244.
- Lindell, Michael K. and Ronald W. Perry. 2004. *Communicating Environmental Risk in Multiethnic Communities*. Sage Publications. Thousand Oaks, CA.
- Liu, S., L. E. Quenemoen, J. Malilay, E. Noji, T. Sinks, and J. Mendlein. 1996. Assessment of a severe-weather warning system and disaster preparedness, Calhoun County, Alabama, 1994. *American Journal of Public Health*, 86(1), 87–89.
- Mallett, Launa, Charles Vaught, and Michael J. Brnich Jr. 1993. Sociotechnical Communication in an Underground Mine Fire: A Study of Warning Messages During an Emergency Evacuation, *Safety Science*, 16, 709–728.
- Mayhorn, Christopher B. and Anne Collins McLaughlin. *In press*. Warning the World of Extreme Events: A global perspective on risk communication for natural and technological disaster. *Safety Science*. Available online 7 June 2012.
- Mileti, Dennis S. 1974. *A Normative Causal Model Analysis of Disaster Warning Response*. University of Colorado Department of Sociology. Boulder, CO.
- Mileti, Dennis S. and JoAnne DeRouen Darlington. 1995. Societal Response to Revised Earthquake Probabilities in the San Francisco Bay Area. *International Journal of Mass Emergencies and Disaster*, 13(2), 119–145.
- Mileti, Dennis S. and Paul W. O'Brien. 1993. Public Response to Aftershock Warnings. Washington, DC: Geological Survey, U.S. Department of the Interior.
- Mileti, Dennis S. and Colleen Fitzpatrick. 1991. Communication of Public Risk: Its Theory and its Application. *Sociological Practice Review*, 2(1), 20–28.
- Mileti, Dennis S. and E. M. Beck. 1975. Communication in Crisis: Explaining evacuation symbolically. *Communication Research*, 2(1), 24–49.
- Moore, H. E. 1958. *Tornadoes over Texas: A Study of Waco and San Angelo in Disaster*. University of Texas Press. Austin, TX.

- National Fire Protection Association. 2013. *U.S. National Fire Alarm and Signaling Code*. NFPA 72. Quincy, MA.
- NBCActionNews. 2011. Survivor shares tale of Pizza Hut hero. YouTube. May 24. Accessed January 31, 2013. www.youtube.com/watch?v=3SuN45tdSBE&feature=related.
- Neuwirth, Kurt, Sharon Dunwoody, and Robert J. Griffin. 2000. Protection Motivation and Risk Communication. *Risk Analysis*, 20(5), 721–734.
- NWS (National Weather Service). 1993a. *National Disaster Survey Report: Tampa Bay Area Tornadoes, October 3, 1992*. Silver Spring, MD.
- NWS (National Weather Service). 1993b. *National Disaster Survey Report: The Widespread November 21–23, 1992, Tornado Outbreak: Houston to Raleigh and Gulf Coast to Ohio Valley*. Silver Spring, MD.
- NWS (National Weather Service). 2009. *Service Assessment: Mother's Day Weekend Tornado in Oklahoma and Missouri, May 10, 2008*. Silver Spring, MD.
- NWS (National Weather Service). 2011. *NWS Central Region Service Assessment Joplin, Missouri, Tornado—May 22, 2011*. Silver Spring, MD.
- Perry, Ronald W. and Michael K. Lindell. 1986. *Twentieth-Century Volcanicity at Mt. St. Helens: The routinization of life near an active volcano*. Tempe, AZ: School of Public Affairs, Arizona State University.
- Proulx, Guylene and Joelle Pineau. 1996. The Impact of Age on Occupants' Behaviour during a Residential Fire. In *Proceedings of the Human Factors and Ergonomics Society 40th Annual Meeting*. Santa Monica, CA: Human Factors and Ergonomics Society.
- Sanderson, L. M. 1989. Tornadoes. In *The Public Health Consequences of Natural Disasters 1989*. U.S. Centers for Disease Control and Prevention. Atlanta, GA, 39–49.
- Sellnow, Timothy L., Deanna D. Sellnow, Derek R. Lane, and Robert S. Littlefield. 2012. The Value of Instructional Communication in Crisis Situations: Restoring order to chaos. *Risk Analysis*, 32(4), 633–643.
- SEMA (MO State Emergency Management Agency), Joplin–Jasper County Emergency Management Agency, Jasper County Officials, and City of Joplin Officials. 2011. *Joplin/Jasper County Emergency Operations Plan*.
- Simmons, Kevin M. and Daniel Sutter. 2011. *Economic and Societal Impacts of Tornadoes*. American Meteorological Society. Boston, MA.
- Skinner, Cal. 2011. Joplin tornado—What happened at the AT&T store across from Walmart. *McHenry County Blog*. Accessed January 31, 2013. <http://mchenrycountyblog.com/2011/05/28/joplin-tornado-what-happened-at-the-att-story-across-from-walmart/>.

- Slovic, Paul, Ellen Peters, Melissa L. Finucane, Ellen Peters, Donald G. MacGregor. 2004. Risk as Analysis and Risk as Feelings: Some thoughts about affect, reason, risk and rationality. *Risk Analysis* 24(2): 311–322.
- Sorensen, John H. 1991. When Shall We Leave? Factors Affecting the Timing of Evacuation Departures. *International Journal of Mass Emergencies and Disasters*, 9(2), 153–165.
- Sorensen, John H., Barry L. Shumpert, and Barbara M. Vogt, 2004. Planning for Protective Action Decision Making: Evacuate or shelter-in-place. *Journal of Hazardous Materials*, 109(1–3), 1–11.
- Stefanoni, Andra Bryan. 2011. Joplin Elks Lodge mourns members lost when storm destroyed building. *Joplin Globe*. June 4, 2011. Accessed December 29, 2012.
- Stephens, Keri K., Ashley K. Barrett, and Michael J. Mahometa. 2013. Organizational Communication in Emergencies: Using multiple channels and sources to combat noise and capture attention. *Human Communication Research*, 39(2), 230–251.
- Tetz, Gary. 2011. Nursing home residents dead after Missouri tornado. McKnight’s Long-Term Care News and Assisted Living. May 25, 2011. Accessed December 29, 2012. <http://www.mcknights.com/nursing-home-residents-dead-after-missouri-tornado/article/203689/>.
- Turner, Randy and John Hacker. 2011. *5:41: Stories from the Joplin Tornado*. Randy Turner. Joplin, MO.
- Turner Report Blog. 2011. Home Depot employees honored for saving lives during tornado. June 2, 2011. Accessed December 29, 2012. <http://rturner229.blogspot.com/2011/06/home-depot-employees-honored-for-saving.html>.
- U.S. Census Bureau. 2010. State and County QuickFacts, Joplin (city), Missouri. Accessed December 2012. www.quickfacts.census.gov.
- U.S. Census Bureau. 2011. Census Data and Emergency Preparedness—2011 Tornadoes: Joplin, Missouri EF-5 Tornado: May 22, 2011. Accessed January 2013. www.census.gov/newsroom/emergencies/2011_tornadoes.html.
- Vihalemm, T., M. Kissel, and H. Harro-Loit. 2012. Citizens’ Response Patters to Warning Messages. *Journal of Contingencies and Crisis Management*, 20(1), 13–25.
- Wang, X. H. and N. Kapucu. 2008. Public complacency under repeated emergency threats: Some empirical evidence. *Journal of Public Administration Research and Theory*, 18(1), 57–78.
- Word&Way. 2012. Unity a positive outcome of loss to deadly Joplin tornado. *Word&Way*. May 29, 2012. Accessed December 29, 2012.
- Yunker, Emily. 2011a. Nursing home residents, staff had no place to go. *Joplin Globe*. July 16, 2011. Accessed January 2, 2013.

Yunker, Emily. 2011b. Employee recounts tornado inside destroyed Home Depot. *Joplin Globe*. May 25, 2011. Accessed December 29, 2012.

Yunker, Emily. 2011c. Daniel Fluharty: Pizza Hut survivor. *Joplin Globe*. July 29, 2011. Accessed December 20, 2012. www.joplinglobe.com/tornado_miracles/x1073354611/Daniel-Fluharty-Pizza-Hut-survivor.

This page intentionally left blank.

Chapter 5

FINDINGS AND RECOMMENDATIONS

5.1 PRINCIPAL FINDINGS

The National Institute of Standards and Technology (NIST) developed findings based upon information collected during and after the initial reconnaissance, interviews conducted with survivors, and data analyses related to environmental conditions, building performance, and emergency response and communications activities. These findings are enumerated in Sections 5.1.2 through 5.1.4, following the contextual observations presented in Sec. 5.1.1.

5.1.1 Context for Findings

- National model building codes, standards, and practices seek to achieve life safety for the hazards that are considered in design. While these considerations include hurricane and nontornadic wind, flood, snow, rain, earthquake, and ice loads, they do not include tornado hazards (loads due to wind speeds that significantly exceed code-compliant design wind speed and impacts of wind-borne debris). Thus, buildings and other structures are not designed for tornado hazards currently. The sole exceptions are safety-related structures in nuclear power plants and storm shelters or safe rooms.
- There are currently two tornado hazard maps prescribing different tornado hazard regionalization and associated wind speeds for the contiguous United States:
 - The ANSI/ANS 2.3 (2011), NRC/RG 1.76 (2007), and DOE 1020 (2002) map for designing nuclear-related facilities (three regions, 230 mph maximum wind speed); and
 - The ICC 500 (2008), FEMA 320 (2008), and FEMA 361 (2008) map for designing shelters and safe rooms (four regions, 250 mph maximum wind speed).
- Current building codes and standards prohibit the use of aggregate roof surfacing materials or ballast for hurricane-prone regions,¹⁵⁹ but allow their use in other regions based on mean roof height and exposure category. For the City of Joplin, the building code at the time of the May 22, 2011 Joplin tornado allowed aggregate roof ballast for buildings with a mean roof height of less than 110 ft.
- In the State of Missouri, the adoption and enforcement of building codes are prerogatives of local government. The City of Joplin's building department has a long history of code

¹⁵⁹ Defined in ASCE/SEI Standard 7-10 *Minimum Design Loads for Buildings and Other Structures* as: Areas vulnerable to hurricanes; in the United States and its territories defined as (1) The U.S. Atlantic Ocean and Gulf of Mexico coasts where the basic wind speed for Risk Category II buildings is greater than 115 mph, and (2) Hawaii, Puerto Rico, Guam, Virgin Islands, and American Samoa.

adoptions, and typically has adopted the latest national model building codes shortly after they have been issued.

- Like most other municipalities in tornado-prone areas and the contemporaneous model building codes, the City of Joplin does not mandate the construction of shelters or safe rooms in residential or non-residential facilities. Additionally, the City did not own or operate any public storm shelters. The lack of public shelters and requirements for safe rooms in residential or non-residential facilities meant that many residents in the area affected by the May 22, 2011, Joplin tornado, particularly those who were living in multi-family residential buildings or older nursing homes, did not have access to such sheltering options during this tornado.

5.1.2 Findings Related to Tornado Hazard Characteristics and Associated Wind Field

5.1.2.1 Measurements of the Near-Surface Wind Field in Tornadoes (< 20 m)

Finding 1—

Current operational weather radar technology is incapable of determining tornado occurrence and intensity at heights above the ground that are relevant to structural engineering design (i.e. at the heights of buildings). For example, because the nearest operational radars to Joplin were more than 60 miles away they could only measure conditions at altitudes starting at 5000 ft.

Finding 2—

Reliable direct measurement of wind speed in tornadoes, especially the most intense tornadoes, is lacking or non-existent. Wind speed measurements related, but not directly, to the May 22, 2011, Joplin tornado were limited to one location well outside the tornado damage path. The difficulty in measuring tornado intensity discussed in both Findings 1 and 2 have been noted in previous tornado research.

Finding 3—

NIST estimated the maximum wind speeds in the May 22, 2011, Joplin tornado to be 175 mph with up to 25 percent of uncertainty. With uncertainty, the upper bound of the estimated maximum wind speed in the Joplin tornado was 210 mph. The uncertainty was due to the use of indirect wind speed estimation methods (i.e., tree-fall analysis, EF Scale). Due to the lack of radar and direct wind speed measurements, indirect methods served as the sole estimators of wind speeds in the May 22, 2011, Joplin tornado. While existing indirect methods cannot be used to unambiguously determine wind speeds that can be used in structural design, the remaining findings in this study are not sensitive to the level of uncertainty in this methodology.

Finding 4—

The estimated duration and spatial extent of damaging winds in the May 22, 2011, Joplin tornado were significantly greater than those expected based on those used in current tornado hazard models. This finding is consistent with other studies that have estimated wind fields in actual tornadoes. For example, wind speeds in the Joplin tornado that exceeded those associated with EF-3 accounted for approximately twice the spatial area expected based on modeled estimations for an EF-5 tornado.

5.1.2.2 Assessment of Tornado Climatology, Hazard, and Risk for Structural Design

Finding 5—

The probability of occurrence and subsequent risk of tornadoes is significantly underestimated by point-based methodology. It was shown that actual damage in Joplin and other communities affected by damaging tornadoes was greater than predicted using point-based methodology.

Finding 6—

Tornadoes rated EF-3 or lower have accounted for approximately 96 percent of all U.S. tornadoes between 1950 and 2011, over one-third (36 percent) of the approximately 5,600 tornado-related fatalities over the same period, and about 80 percent of the \$25 billion in estimated property losses incurred due to tornadoes between 1996 and 2011. Even in a tornado with intensity greater than EF-3, the wind speeds in the majority of the affected area are equivalent to or less than the maximum wind speeds associated with EF-3 tornadoes. In the case of the Joplin tornado, approximately 40 percent of the fatalities and as much as 90 percent of the tornado area were associated with EF-3 or lower wind speeds.

5.1.2.3 Limitations of the Enhanced Fujita (EF) Scale

Finding 7—

The Enhanced Fujita scale lacks adequate damage indicators (DI's) and corresponding degrees of damage (DOD's) for distinguishing among the most intense tornado events. The lack of DI's and DOD's and overall nature of the EF-scale requires subjective, non-quantitative assessment of tornado damage.

5.1.3 Findings Related to the Response of Residential, Commercial, and Critical Buildings, Including the Performance of Designated Safe Areas and of Lifelines Pertaining to the Continuity of Building Operations

5.1.3.1 Building Performance

Finding 8—

Buildings are not designed to withstand tornado hazards and there are no building code requirements for tornado-resistant design. Most buildings in the area damaged by the May 22, 2011, Joplin tornado were subjected to wind speeds close to or above the speeds that would be expected to cause collapse or major damage to structures designed to the non-tornadic wind design requirements of the building codes applicable to them. Wind-borne debris, which contributed significantly to building damage in Joplin, also is not considered as a hazard in building design.

Finding 9—

Regardless of construction type, neither affected residential nor non-residential buildings were able to provide life-safety protection in the May 22, 2011, Joplin tornado. Of the 161 fatalities, 135 (or 83.8 percent) were related to building failure. Of these building failure-related fatalities, 74 (52.5 percent) occurred in residential buildings. Of the buildings that were damaged, 7,411 were residential and 553 were non-residential. All 553 of the non-residential buildings and 3,069 (about 43 percent) of the residential structures sustained either *heavy/totalled* or *demolished* damage classification, resulting in

approximately \$1.228 billion in insured losses for non-residential property and \$0.552 billion for residential property.

Finding 10—

Among the engineered buildings surveyed by NIST, those with redundant lateral load capacity and those that did not depend on bracing from the roof system for lateral stability (such as certain steel and concrete moment frame buildings) withstood the tornado without structural collapse. Those with reinforced concrete roofs or composite concrete and steel roofs also withstood the tornado without structural collapse. Those that relied on bracing from a less robust roof system for lateral stability (such as box-type system (BTS) buildings with light steel roof decks) were prone to structural collapse.

Finding 11—

The structural collapses of NIST-surveyed BTS buildings began with failure of the roof system due to wind uplift (failure of roof-deck-to-joist or joist-to-wall connections), which led to the loss of lateral bracing for perimeter walls, causing them to collapse by rotation at the base due to lateral load. Available design information showed that the roof connections of these buildings were adequate for code-level design wind pressures, making it unlikely that these buildings could have failed in wind speeds under 115–120 mph, which are the “ultimate” (that is, sufficient for failure) speeds corresponding to the code-level winds.

Finding 12—

BTS buildings, surveyed by NIST, that sustained total structural collapse had two common design features that increased their vulnerability to collapse in the May 22, 2011, Joplin tornado: light-gauge metal roof systems, and friction-only wall-to-footing connections (currently accepted practice for areas with low or no seismic risk).

Finding 13—

Pre-engineered metal buildings (PEMB) surveyed by NIST sustained significant damage to their envelopes, but no structural collapses of the primary rigid steel frame.

Finding 14—

Failures of residential wood-frame buildings predominantly involved failure of the connections between structural components, rather than of the components themselves (roof, walls, and floor), with the majority involving disconnection of the roof from walls and walls from foundation. This indicates lack of robustness in the connections and in the continuity of the vertical load path from roof to foundation.

Finding 15—

Better structural performance in one of the NIST-surveyed multi-family residential buildings in Joplin can be attributed to use of robust hurricane connectors, typically only required for residential wood-frame buildings in hurricane-prone regions.

Finding 16—

All NIST-surveyed engineered buildings that did not collapse (steel, concrete frame, and PEMB), as well as engineered buildings that collapsed (BTS buildings), sustained significant damage to the building

envelopes and interiors due to the combination of wind pressure, impacts by wind-borne debris, and subsequent water intrusion.

Finding 17—

The failure of building envelopes at St. John’s Regional Medical Center (SJRM), which led to loss of protection and subsequent extensive damage to building interiors (affecting electrical distribution and fixtures, water and gas pipes, HVAC systems and ductwork, and the elevator system and elevator shaft enclosure), was the primary cause for the complete loss of functionality of this critical facility, which occurred despite the robust structural system that withstood the tornado without structural collapse.

Finding 18—

The majority of the impact-resistant windows on the fifth floor (Behavioral Health Unit) of the West Tower of SJRM remained intact, whereas most regular dual-pane insulated windows at SJRM were broken when exposed to the same tornado hazards.

Finding 19—

While there was no direct evidence that roof aggregate contributed to any injuries or fatalities in Joplin, there was evidence that roof aggregates contributed to envelope damage in SJRM buildings and surrounding structures, thus adding to the tornado debris hazard and the potential for injuries or fatalities.

5.1.3.2 Performance of Shelters/Safe Rooms/Designated Refuge Areas

Finding 20—

NIST found that Joplin residents had limited access to underground or tornado-resistant shelters. There were no community shelters or safe rooms in the City of Joplin or Jasper County at the time of the May 22, 2011, Joplin tornado. Also, 82 percent of the homes in Joplin lacked basements. Only a few non-residential buildings were equipped with underground locations (e.g., basements), and none was identified as having a tornado-resistant shelter above ground.

Finding 21—

While many non-residential facilities had designated refuge areas, several of these areas suffered severe damage and NIST found no evidence that these areas yielded positive outcomes with respect to loss of life. Most high-occupancy commercial and critical facilities surveyed by NIST in the tornado-affected area (SJRM, schools, and big-box stores) had in-facility designated refuge areas for tornadoes. However, the locations of these areas were not always based solely on structural considerations. There are currently no design standards, requirements, or best-practice guidelines for designating refuge areas within existing commercial or critical buildings.

Finding 22—

Currently, there are optional model code provisions for the design of specially purposed shelters, but such shelters are not required.

Finding 23—

Based on a few instances observed in this tornado, in-home shelters did perform well and provided life-safety protection to the home owners. NIST found no statistics on how many of the 7,411 damaged residential structures had in-home tornado shelters.

5.1.3.3 Performance of Lifelines***Finding 24—***

All utilities (water, gas, power) were lost in the areas damaged by the May 22, 2011, Joplin tornado. The utility providers restored service to critical buildings (SJRMC, water treatment plant) within 24 hours.

Finding 25—

The failure of building envelopes at NIST-surveyed critical facilities, and resultant severe damage to their interior and internal lifeline distribution systems, was the primary cause of the facilities' complete loss of functionality despite restoration of utility services within 24 hours.

Finding 26—

In critical facilities constructed in Joplin prior to 1998, the design wind speed for high-occupancy buildings was higher than that specified for buildings housing the facilities' backup power generators.

5.1.4 Findings Related to the Pattern, Location, and Cause of Fatalities and Injuries, and Associated Performance of Emergency Communications Systems and Public Response***Finding 27—***

During the period from 1950 (i.e., the beginning of official tornado record keeping) through 2011, tornadoes caused approximately 5,600 fatalities in the United States. Within an 80-mile radius around Joplin, 233 deaths (including those caused by the Joplin tornado) were caused by tornadoes during the same period.

Finding 28—

The Missouri State Police attributed 161 deaths and the City of Joplin attributed more than 1,000 injuries to the Joplin tornado, which affected an area with an estimated population of 20,820.

Finding 29—

Of the 161 deaths resulting from this tornado, 155 (96 percent) were caused by impact-related factors (i.e., multiple blunt force trauma to the body). The others were caused by stress-induced heart attacks, pneumonia, or lightning.

5.1.4.1 Emergency Communication Prior to May 22, 2011

Finding 30—

There was evidence of high false–alarm rates among the storm–based tornado warnings officially issued for Joplin. From 2005 through 2011, 78 percent (14 out of 18) of the official tornado warnings issued for Joplin did not result in a tornado; this percentage was in line with the 2007–2011 national average storm–based tornado false–alarm rate of 74.7 percent. More recently, over the 5–year period from 2007 through 2011, the Joplin area false–alarm rate increased to 92 percent.

Finding 31—

Despite public perception, no evidence was found of high false–alarm rates for Joplin’s outdoor siren system. Since 2007, the average rate of activation of the 25–siren outdoor warning system in Joplin was once per year (at most), not including the test activations (1 minute in duration) that occurred weekly.

Finding 32—

Joplin residents interviewed after the Joplin tornado believed that there had been a high number of false alarms in Joplin from official tornado warnings and the City’s outdoor siren system prior to 2011, even though the siren activation rate was once per year (on average).

5.1.4.2 Tornado History Prior to May 22, 2011

Finding 33—

Prior to 2011, the roughly 30–square–mile City of Joplin had experienced one tornado rated EF–2 or greater since 1950; this tornado occurred on May 5, 1971. However, also since 1950, 182 tornadoes rated EF–2 or higher had struck within an 80–mile radius of the City.

Finding 34—

Prior to the May 22, 2011, Joplin tornado, scientifically unfounded beliefs about tornado movements and the effects of regional topography contributed to a common public perception that the City of Joplin was immune to a direct tornado strike.

5.1.4.3 Emergency Communication on May 22, 2011

Finding 35—

Two official tornado warnings were issued on May 22, 2011. After the first official warning, Joplin’s sirens were sounded but no tornado occurred. After the second official warning, the siren system was sounded again, 4 minutes after the tornado touched down and almost exactly when the tornado entered the City of Joplin. Both siren soundings took the form of a continuous tone of 3 minutes duration.

Finding 36—

The function of an alert is to grab people’s attention before/during a disaster; while the function of a warning is to provide information about the event and how the public should respond. Both are necessary in an emergency. Joplin’s outdoor siren system, which could generally be heard indoors as well as outside, was the primary means by which individuals were alerted to a tornado event on May 22, 2011.

Radio, television, and word of mouth were the primary means by which individuals were provided with warning information on May 22, 2011.

Finding 37—

The Joplin–Jasper County Reverse–9–1–1 telephone system was not used on May 22, 2011, due to its inability to disseminate information in a timely manner. It had taken up to 3 hours to get emergency calls out during previous uses, so it is unlikely that the system would have worked in this tornado event.

Finding 38—

Functioning as an alerting system, only, the outdoor sirens prompted many Joplin residents and visitors to seek further information on May 22, 2011. The multiplicity of information sources, and the conflicting information provided by those sources, added to the public’s confusion about the true hazard as additional information was sought.

Finding 39—

Across the country, there is no standard method for sounding outdoor public siren systems, which has led to variations in siren usage, activation procedures, and sounding patterns among U.S. communities. Also, there are no nationally accepted standard protocols for the issuance of an all–clear alert following a warning.

Finding 40—

Of the 155 impact–related fatalities, 135 (87 percent) involved persons who are known to have been located inside structures during the tornado. The structures in which these people died included both residential (59 percent of the 135 victims) and non–residential (41 percent) buildings.

Finding 41—

Virtually all of the buildings in which the 135 impact–related fatalities occurred experienced maximum estimated winds associated with tornadoes rated EF–3 or higher. The exceptions were the Meadows Healthcare facility, where two of the deaths occurred, and five single–family homes that were the sites of six of the fatalities.

Finding 42—

The hospital towers at SJRMC did not provide life–safety protection for all occupants, even though the towers did not collapse. Twelve impact–related fatalities occurred in the hospital, four of which involved patients in intensive care units.

Finding 43—

Responses to the approaching tornado among members of the public, in many cases, were delayed or incomplete, as was evidenced by the fatalities that occurred among individuals located outdoors, in vehicles, or en route within buildings to safer refuges when the tornado hit.

Finding 44—

Two factors were found to have contributed to the delayed or incomplete public response to the Joplin tornado. The first was a lack of awareness of the tornado. The second was an inability to perceive

personal risk due to one or more of the following: receipt of conflicting or uncertain information about the tornado; pre-existing beliefs about Joplin's immunity to direct tornado strikes; and distrust of or confusion about Joplin's emergency communications system.

Finding 45—

The main factor that convinced individuals to take shelter was the receipt of high-intensity cues, including hearing or seeing the tornado approaching or witnessing others' urgency related to taking protection.

Finding 46—

No fatalities occurred in demolished, detached homes in which people took refuge in basements. Additionally, NIST found no evidence that any of those killed were located underground during the tornado.

Finding 47—

A disproportionate number of people aged 60 years or older died or were injured as a result of this tornado. NIST analysis of the fatalities resulting from the Joplin tornado shows that approximately 8 fatalities occurred per thousand people in Joplin aged 60 years and over compared with 2 fatalities per thousand people in Joplin under 60 years. This disproportionate result remains even after removing all hospital and nursing home deaths. Factors that may have contributed to this outcome include a lack of information flow to these individuals, a lack of supportive social networks among individuals, or inability of an individual to withstand or recover from tornado-induced trauma.

5.2 RECOMMENDATIONS

As part of its technical investigation of the Joplin tornado, NIST has developed 16 recommendations for improving how buildings and shelters are designed, constructed, and maintained in tornado-prone regions, and for improving the emergency communications that warn of imminent threats from tornadoes. These recommendations are presented in three groups (Sections 5.2.1 through 5.2.3) that reflect the objectives and findings of the investigation.

The first group of recommendations is focused on the characteristics of tornado hazards and their associated wind fields. The recommendations in the second group concern the performance of buildings, lifelines, and shelters and designated safe areas. The final group of recommendations relates to findings about the pattern, locations, and causes of tornado fatalities and injuries, the performance of emergency communications systems, and the public response to this tornado.

The recommendations call for action by specific entities with regard to the development, adoption, and enforcement of standards, codes, and regulations; professional and construction practices, education, and training; and research and development. NIST believes that these recommendations are realistic and appropriate, and are achievable within a reasonable period of time.

NIST strongly urges state and local authorities having jurisdiction to adopt and enforce model building codes and standards. Enforcement is critical to ensuring expected levels of safety. Following good

building practices also is critical to achieving better performance of structures during extreme events like tornadoes.

5.2.1 Recommendations Related to Tornado Hazard Characteristics and Associated Wind Field

Recommendation 1—

NIST recommends that a capacity be developed and deployed that can measure and characterize actual near-surface tornadic wind fields for use in the engineering design of buildings and infrastructure. This would require enhancement and widespread deployment of advanced technologies, including weather radar.

Justification:

NIST found that current operational weather radar technology is incapable of determining tornado occurrence and intensity for heights at which most structures are built. Recently proven, cost-effective, short-range remote sensing technologies (i.e., Collaborative Adaptive Sensing of the Atmosphere, or CASA radar) can be more widely implemented in tornado-prone areas as an initial step to serve this purpose. Although these technologies would not measure the area immediately adjacent to ground level, they could serve as an important bridge between higher elevations sampled by NWS radar and estimates of the near-surface wind field discussed later in this recommendation. These technologies could also be used to improve warning lead time and false alarm rates for tornadoes (see Recommendation 16).

NIST also found that direct, near-surface wind speed measurements relevant to the Joplin tornado were available from only one weather station situated well outside the tornado damage path. Reliable measurements of near-surface wind speed and other information (e.g., wind-induced pressure) in tornadoes, especially in the most intense portions of them, are lacking or nonexistent due to both the scarcity and durability of measuring devices. This lack of measurements makes it extremely difficult to understand the relationship between damage and wind speed. Improved characterization of the tornado hazards at elevations that are meaningful for engineering design can be achieved by development and use of ruggedized, tornado- and tornado debris-resistant technology capable of directly measuring near-surface wind speeds, wind pressure, impact loading, and turbulence produced by tornadoes and other extreme wind events.

As radar-based and direct measurements of wind speed in tornadoes are lacking, indirect methods (e.g., tree fall) were used to assess the maximum wind speeds of the Joplin tornado. However, considerable uncertainty still exists in these estimations. For example, estimated maximum wind speeds based on tree fall analysis in the Joplin tornado were 175 mph with up to 25% of model uncertainty. Including uncertainty, the upper bound of maximum wind speed was estimated to be 210 mph. Using the EF Scale, maximum wind speeds based on damage to structures surveyed by NIST were estimated to be 150 mph with 10% uncertainty (± 15 mph) due to the large size of the structures rated. The range of wind speeds for “demolished” residential structures using the EF Scale was 110 mph to 175 mph. Uncertainties in wind speed estimation can be reduced by improving upon existing techniques like tree fall and the EF Scale (Recommendation 4) as described in this report, or by further developing other computational or analytical methods (e.g., back-calculations from structural or structural-element failures, debris flight). The maximum estimated near-surface wind speeds

derived from indirect methods suggest that the extent of damage in Joplin could have been caused by wind speeds lower than those associated with an EF-5 tornado (200+ mph).

Improving measurements of the *entire* near-surface tornadic wind field will also be useful for properly assessing tornado climatology, associated probabilistic estimates of the tornado hazard, and for calibrating the EF Scale. Tree fall analysis of the Joplin tornado suggested that damaging wind speeds lasted for a longer duration over a larger spatial area than was expected based on current tornado hazard estimation approaches. This finding is consistent with other studies that have estimated wind fields in actual tornadoes. In areas subjected to the highest wind speeds in the Joplin tornado, the duration of wind speeds at or above wind speeds associated with the EF-2 range was estimated to be over 1 min and the total area of EF-3 or greater wind speeds was approximately twice that expected under current tornado hazard models. The wind speed duration should be thoroughly considered when assessing damage, estimating wind speeds, and designing structures for tornadoes.

Interested Parties: Academia, Industry, National Oceanic and Atmospheric Administration (NOAA)/National Weather Service (NWS), U.S. Nuclear Regulatory Commission (NRC), National Science Foundation (NSF), U.S. Department of Energy (DOE)

Organization with Lead Responsibility for Implementation: NOAA

Recommendation 2—

NIST recommends that information gathered and generated from tornado events (such as the Joplin tornado) should be stored in publicly available and easily accessible databases to aid in the improvement of tornado hazard characterization.

Justification:

Characterization of the tornado hazard in Joplin benefited from information available from radar and anemometer measurements, pre- and post-storm aerial imagery, ground-based damage surveys, and photographs, as well as from damage and property databases. Archived storage of such information in publicly available and easily accessible databases, especially in conjunction with a geospatial software platform that permits detailed mapping of tornado events, would greatly facilitate characterization of the tornado hazard and associated risk.

Interested Parties: Academia, Federal Emergency Management Agency (FEMA), Industry, National Geospatial-Intelligence Agency, NOAA/NWS

Organization with Lead Responsibility for Implementation: NOAA

Recommendation 3—

NIST recommends that tornado hazard maps for use in the engineering design of buildings and infrastructure be developed considering spatially based estimates of the tornado hazard instead of point-based estimates.

Justification:

NIST found that current estimations of the tornado hazard using tornado area (i.e. point-based) are insufficient when considering populated areas. This insufficiency was demonstrated by the larger

spatial extent and longer duration of the wind field in Joplin compared to tornado hazard models (Finding 4) and by the amount and effects of wind-borne debris in Joplin. Debris from structures was shown to have significantly contributed to the overall damage state (Findings 8, 16) and to the potential for injuries and fatalities in Joplin (Findings 19, 29). The extent of damage to residential structures in Joplin was greater than predicted based on point-based estimations of tornado damage. For example, it was estimated that 28 percent of the damaged residential homes had EF-3 or greater damage versus the 12 percent predicted for an EF-5 tornado from point-based methods, and 43 percent of structures were estimated to have EF-2 or greater damage while only 30 percent of the tree fall-based wind field was estimated at EF-2 or greater. This greater-than-expected level of damage has also been noted in other recent, significant tornadoes that have struck populated areas, such as the tornadoes that damaged Oklahoma City in 1999 and Tuscaloosa in 2011.

Also, in populated areas such as Joplin, even though only part of the community is affected physically, the wider community is impacted. For example, 7,411 residential structures were damaged in Joplin, but approximately 20,000 structures were without power following the storm, showing that the tornado hazard and associated risk extended beyond the tornado damage path.

As communities continue to expand, additional risks are created by growing populations and population centers. Risks of populated communities were analyzed using the spatially based methodology across the United States. Results from the NIST analysis show that populated regions are at a significantly higher risk from tornado damage than what is prescribed in current point-based estimations.

Tornadoes rated EF-3 or lower have accounted for approximately 96 percent of all tornadoes in the official record and are associated with significant fatalities and economic losses. Over one-third (36 percent) of fatalities and about 80 percent of insured property losses have been caused by EF-3 or lower tornadoes. Even in tornadoes rated higher than EF-3, the majority of affected areas encounter EF-3 or lower wind speeds. In the case of the Joplin tornado, approximately 40 percent of the fatalities and up to 90 percent of the tornado area were associated with EF-3 or lower wind speeds.

Interested Parties: American Society of Civil Engineers (ASCE), DOE, FEMA, International Code Council (ICC), NRC

Organization with Lead Responsibility for Implementation: NIST

Recommendation 4—

NIST recommends that new damage indicators (DIs) be developed for the Enhanced Fujita tornado intensity scale to better distinguish between the most intense tornado events. Methodologies used in the development of new DIs and associated degrees of damage (DODs) should be, to the extent possible, scientific in nature and quantifiable. As new information becomes available, a committee comprised of public and private entities should be formed with the ability to propose, accept, and implement changes to the EF Scale. The improved EF Scale should be adopted by NWS.

Justification:

NIST found that the EF Scale lacks adequate DIs and corresponding DODs for distinguishing tornado intensity, especially for tornadoes that cause significant damage. This lack of adequacy is due in part

to the small sample size of intense tornadoes striking heavily populated areas. The lack of DIs and DODs and the overall nature of the EF Scale require subjective, non-quantitative assessment of tornado damage. Damage indicators (DIs) not currently in the EF Scale (e.g., tractor-trailers, manhole covers) were used to help determine the EF-5 designation (200+ mph) for the Joplin tornado. Currently there are only five DODs available for use in evaluating the DIs that can result in an EF-5 rating using an expected value of wind speed.

The lack of adequate DIs and DODs and associated guidance in the EF Scale led, in part, to differences in wind speeds that were estimated based on damage to Joplin structures by NIST and other researchers, practitioners, and surveyors. In addition, the EF Scale implicitly regards wind speed estimates for individual structures as point estimates, and cannot accommodate cases such as Walmart Store #59 in Joplin, where some sections of a single, large structure were more heavily damaged than others. NIST's wind speed estimation from tree fall showed that wind speeds varied significantly over the length of the Walmart building. A similar observation was noted by FEMA, after their study of both the Joplin and Tuscaloosa (and other Alabama) tornadoes.

Further refinement of the EF Scale and its procedures will enhance the estimation of maximum wind speeds and subsequent EF ratings in tornadoes, by providing official surveyors with additional and improved guidance. Recent research has stressed that a path toward modifying the EF Scale is a pressing need. An iterative development process will not only enable better wind speed estimation, but also will lead to greater understanding of the response of structures to tornadoes. Ultimately, it will improve estimates of tornado hazard climatology and of the risk that tornadoes pose to the public.

Interested Parties: Academia, FEMA, Industry, NOAA/NWS, NSF, Office of Science and Technology Policy

Organization with Lead Responsibility for Implementation: NOAA/NWS

5.2.2 Recommendations Related to the Performance of Buildings, Shelters/Designated Safe Areas, and Lifelines

Recommendation 5—

NIST recommends that nationally accepted performance-based standards for the tornado-resistant design of buildings and infrastructure be developed in model codes and adopted in local regulations to ensure the resiliency of communities to tornado hazards. The standards should encompass tornado hazard characterization, performance objectives, and evaluation tools. The standards shall require that critical buildings and infrastructure such as hospitals and emergency operations centers are designed so as to remain operational in the event of a tornado.

Justification:

Currently, there are no standards for the tornado-resistant design of ordinary buildings and infrastructure, except for *safety-related structures in nuclear power plants and storm shelters or safe rooms*. Even in the design standards for *nuclear power plants, storm shelters, and safe rooms* (ANSI/ANS 2.3 (2011) and ICC 500 (2008)), there are inconsistencies in the way tornado hazards are characterized, as reflected in the different tornado regionalization and associated tornado design wind speeds for the contiguous United States.

Performance-based standards for tornado-resistant design of ordinary buildings – including critical facilities, commercial and residential buildings – will result in more tornado-resilient communities (in terms of enhanced occupants’ life safety and reduced property damage and economic loss) by explicitly considering tornado hazards, which will be characterized by the most up-to-date tornado data and risk-consistent science-based methodologies, as a structural design condition.

The recommended standards would:

- Prescribe “tornado-prone areas” for design (i.e., regionalization of expected tornado wind speeds and wind-borne debris loading) based on a review of the most up-to-date tornado data and hazard mapping methodology;
- Specify “design tornadoes” for buildings (wind speed and debris impact loading) in accordance with the prescribed tornado-prone areas and based on buildings’ Risk Categories; and
- Specify “tornado performance objectives” for buildings, also based on buildings’ Risk Categories. An example of a tornado performance objectives matrix that prescribes the required performance for buildings of different risk categories is shown below:

Tornado Intensities	Performance Objectives			
	Operational	Repairable Occupancy	Life Safe	Collapse Prevention
EF1 (86-110 mph)				
EF2 (111-135 mph)			Risk Cat. II*	
EF3 (136-165 mph)				(1 or 2)
EF4 (166-200 mph)			Risk Cat. III*	
EF5 (> 200 mph)	Risk Cat. IV Facilities*			(1)

(1) Hardened area, shelter-in-place.

(2) Public shelter.

* Based on ASCE 7-10.

Interested Parties: Academia, ASCE, Design and construction industry (American Concrete Institute [ACI], American Institute of Steel Construction [AISC], American Welding Society [AWS], Portland Cement Association [PCA], Steel Deck Institute [SDI], Steel Joist Institute [SJI], The Masonry Society [TMS]), FEMA, ICC, NIST

Organization with Lead Responsibility for Implementation: ASCE

Recommendation 6—

NIST recommends the development of risk-consistent, performance-based tornado design methodologies to ensure that all building components and systems meet the same performance objectives when subjected to tornado hazards.

Justification:

There is currently no methodology for building design that specifically considers the design hazards associated with tornadoes. The minimum code requirements for wind loading in current building codes do not take into account the inconsistent performance of different building components (walls versus roof, structural system versus envelope, structural system versus in-facility lifeline distribution systems (power, gas, water)) when subjected to tornado hazards. It is frequently observed (including in the more recent May 20, 2013 Moore, Oklahoma tornado (NIST SP 1164, 2013)) that the overall outcomes of buildings in tornadoes, in terms of building's structural performance and functionality, can be critically dependent upon the performance of different building components and systems that may not have been designed for the same risk level (buildings' structural systems versus their envelopes, for example). Failure of building envelopes, despite the robust structural system that could withstand the tornado without structural collapse, often resulted in extensive damage to building interiors (affecting electrical distribution and fixtures, water and gas pipes, HVAC systems and ductwork, and the elevator system and elevator shaft enclosure) and ultimately the complete loss of building's functionality).

The new performance-based tornado design methodology would:

- Outline risk-consistent design procedures based on a holistic approach for building design that encompasses the structural system, envelope, and building mechanical, electrical and plumbing lifeline systems.
- Incorporate current best tornado-resistant practices and address design approaches that, while satisfying current minimum code requirements, might not be tornado-resilient based on observed performance for different types of construction, including:
 - For box-type system (BTS) buildings: There is a need to improve robustness and redundancy in lateral load resistance systems by (a) ensuring risk-consistent performance between the roof system and bearing walls, and (b) requiring walls to have rotational restraint capability (instead of friction-only) to reduce dependency on the roof as the sole lateral bracing for collapse prevention.
 - For engineered steel- and concrete-frame buildings and pre-engineered metal buildings: These structures require consistent performance between the building envelope and the main wind-force resisting system (synergy between improved envelope performance using impact-resistant windows and the need to provide protection for special portions of critical facilities, e.g., behavioral health unit in a hospital, should be exploited in planning for protection of the envelope and selection of the best available refuge areas in critical facilities).

- For wood–frame and combined unreinforced masonry–wood roof truss residential buildings: Improved tornado performance in residential construction by requiring a system integrity design approach to ensure a continuous vertical load path from roof to foundation (robust connections between roof, walls, and foundation to ensure they remain connected, albeit damaged). This would improve individual building structural performance and at the same time reduce overall wind–borne debris hazards in tornado–affected communities.

Interested Parties: Academia, ASCE, Design and construction industry (ACI, AISC, AWS, PCA, SDI, SJI, TMS), ICC,

Organization with Lead Responsibility for Implementation: NIST, FEMA

Recommendation 7—

NIST recommends that: (a) model building codes for new buildings require that tornado shelters be designed in accordance with the ICC 500 standard; (b) model building codes develop and adopt a tornado shelter standard specific for existing buildings; and (c) tornado shelters be installed in new and existing multi–family residential buildings, mercantile buildings, schools and buildings with assembly occupancies located in tornado hazard areas identified in the performance–based standards required by Recommendation 5.

Justification:

- NIST found inadequate performance among the *best available refuge areas* in the high–occupancy commercial BTS buildings that it surveyed.
- Without community–based shelters or shelters/safe rooms in multi–family housing and nursing homes, residents of these buildings really had no effective sheltering options during the Joplin tornado.
- Home Depot found that it was feasible to include a hardened refuge area in the store that it built to replace the store demolished in the May 22, 2011, Joplin tornado (the earlier store had no such area).

Interested Parties: Academia, FEMA, ICC, States and authorities having jurisdiction (AHJ) in tornado–prone areas

Organization with Lead Responsibility for Implementation: ICC

Recommendation 8—

NIST recommends the development and implementation of uniform national guidelines that enable communities to create the safest and most effective public sheltering strategies. The guidelines should address planning for, siting, designing, installing, and operating public tornado shelters within the community.

Justification:

NIST found that an overwhelming majority of the fatalities in Joplin (96 percent) were caused by impact-related factors (usually labeled by authorities as multiple blunt-force trauma to the body). A majority of these victims (83.8 percent) were located inside buildings when they were fatally injured. And, many of the buildings they occupied were demolished by the storm, meaning that the roof and walls collapsed, or sustained a “heavy/totaled” level of damage, where there was loss of a significant portion of or the entire roof system, which exposed the building interior to weather damage and debris.

Additionally, NIST found that individuals had often sheltered above ground in these heavily damaged buildings, or in vehicles, and that few among the affected populace had access to underground or tornado-resistant shelters. There were no community shelters or safe rooms (defined as structures designed in accordance with either the ICC 500 standard or FEMA 361 guidance) in the City of Joplin or Jasper County at the time of the May 22, 2011, Joplin tornado. Also, 82 percent of the homes in affected area in Joplin lacked basements. Only a few commercial buildings were equipped with underground locations, and none with tornado-resistant above-ground shelters. Although above-ground residential crawl spaces were often available for sheltering, residents generally did not use them during the May 22, 2011, Joplin tornado because they perceived that they had insufficient time to access them or that the crawl spaces would be too difficult or uncomfortable to use as shelters.

In this particular storm, the residents of Joplin might have benefited from more sheltering options and potentially sustaining fewer deaths and injuries. However, NIST recommends the development of guidelines that municipalities in tornado-prone areas can use to design and implement their own sheltering solutions, rather than mandating a single sheltering strategy (or solution) for every community located in these areas. The guidelines would allow each community to assess their current sheltering capabilities and to develop the safest, most efficient, and most economical sheltering strategy possible based upon the needs of the community (e.g., population size, public comfort with alternative sheltering solutions, training and education, public vulnerabilities), the types of construction within the community, and cost.

Interested Parties: FEMA, ICC, National Fire Protection Association (NFPA), NWS, NSF

Organization with Lead Responsibility for Implementation: FEMA

Recommendation 9—

NIST recommends that uniform guidelines be developed and implemented nationwide for conducting tornado risk assessments and designating best available tornado refuge areas as an interim measure within buildings until permanent measures fully consistent with Recommendations 5 and 7 are implemented.

Justification:

NIST found that, based on its surveys of affected buildings and its interviews with building occupants in Joplin, practices for selecting best available refuge areas were ad hoc and had varying degrees of effectiveness, and could be based on considerations other than structural safety (e.g., proximity to an emergency exit or bathroom). In addition, NIST found that the guidance currently available on selecting refuge areas within buildings is either too general, on the one hand, or too specific to a given type of structural system, on the other.

NIST found some tornado-resistant design features in the BTS buildings that it surveyed in Joplin, including a partially fixed-end condition for perimeter walls (designed to brace against accidental truck impacts but not required in regions of low seismic hazard) that appeared to have kept walls from collapsing in the tornado. Such features should be exploited in selecting best available refuge areas in BTS buildings in tornado-prone areas. The recommended guidelines would help responsible parties identify such features and select the most effective refuge areas in different types of buildings in tornado-prone areas.

Interested Parties: Academia, FEMA, DHS S&T, ICC, States and AHJs in tornado-prone areas

Organization with Lead Responsibility for Implementation: FEMA

Recommendation 10—

NIST recommends that aggregate, gravel, or stone be prohibited as roof surfacing material or roof ballast for buildings of any height in tornado-prone areas.

Justification:

Section 1504.8 of the 2012 *International Building Code* (IBC) prohibits the use of aggregate as roof surfacing materials and as roof ballast for buildings in hurricane-prone regions and buildings in non-hurricane regions with mean roof heights (MRH) that exceed a specified height limit (limit varies depending on the required basic wind speed and exposure category of the building). For Joplin (90 mph basic wind speed and Exposure Category B), aggregate roof ballast was prohibited only for buildings with a MRH exceeding 110 ft. Several buildings at SJRMC had aggregate roof ballast and the roof aggregates were found to have contributed to the wind-borne debris hazard during the Joplin tornado.

Interested Parties: ASCE, ICC, States and AHJs

Organization with Lead Responsibility for Implementation: ICC

Recommendation 11—

NIST recommends that enclosures of egress systems (elevators, exits) in critical facilities in tornado-prone areas be designed to maintain their functional integrity when subjected to tornado hazards.

Justification:

Section 713.3 of the 2012 IBC stipulates that enclosures for elevator shafts shall be of *materials permitted by the building type of construction*. This could mean non-impact-resistant materials such as gypsum board on steel studs are allowed for use as elevator shaft enclosure, as was the case for the elevator shaft in SJRMC's elevator tower. It was found that the shaft enclosure at SJRMC was damaged due to debris infiltration and thus could have impeded the functionality of the elevator even if the power had not been lost.

Interested Parties: Building owners/operators, ICC

Organization with Lead Responsibility for Implementation: ICC

Recommendation 12—

NIST recommends that owners and operators of existing critical facilities in tornado-prone areas perform tornado vulnerability assessments and take steps to ensure the functionality of (1) backup power supplies (harden the protection of emergency backup power, as region-wide losses of power due to damage to power transmission infrastructure occur frequently in tornadoes), (2) vertical movement within the building (elevator equipment and shaft enclosures), and (3) means of egress illumination (battery-powered lighting in addition to backup power), in a tornado event.

Justification:

Loss of backup power supplies, vertical movement, and means of egress illumination occurred frequently in existing critical facilities during tornadoes. This can result in hazardous conditions for post-tornado rescue and evacuation, and ultimately loss of building functionality. Pre-tornado assessment and identification of vulnerabilities of critical facilities to ensure continuity and integrity of backup power supplies, vertical movement, and means of egress illumination, based on lessons learned from past tornadoes, should result in improved outcomes with regard to rescue operations, safe evacuation and continued operation of existing critical facilities.

Interested Parties: DHS S&T, Building owners/operators, States and AHJs

Organization with Lead Responsibility for Implementation: DHS IP/FEMA

5.2.3 Recommendations Related to the Pattern, Location, and Cause of Fatalities and Injuries, and Associated Performance of Emergency Communications Systems and Public Response**Recommendation 13—**

NIST recommends the development of national codes and standards and uniform guidance for clear, consistent, and accurate emergency communications, encompassing alerts and warnings, to ensure safe, effective, and timely responses among individuals, organizations, and communities in the path of storms having the potential to create tornadoes.

NIST also recommends that emergency managers, the NWS, and the media develop a joint plan and take steps to ensure that accurate and consistent emergency alert and warning information is communicated in a timely manner to enhance the situational awareness of community residents, visitors, and emergency responders affected by an event.

Justification:

NIST found that many U.S. communities, even within the same state or region of a state, create and disseminate emergency communications for tornadoes in different ways. In Missouri, for example, according to the emergency manager (EM) for Joplin–Jasper County, it is the responsibility of the EM of each municipality in Jasper County to design the emergency communication system used to alert and warn the local populace about tornadoes. Currently, no federal, state, or local guidance or requirements exist that standardize such systems, which has resulted in different systems and operating practices (at least for the use of outdoor warning sirens for tornadoes) from one

municipality to another. NIST also found that some Joplin tornado survivors expressed confusion regarding the protocol used for tornado sirens in the city. The main aspect of confusion was why the first and second siren soundings stopped after 3 minutes had elapsed, because some associated these cessations as signaling the end of the emergency. However, the 3 minute siren duration was part of Joplin’s outdoor warning siren protocol, which was available online as well as in the City’s emergency plans.

Therefore, NIST recommends the development of national codes, standards, and/or guidance for the creation and dissemination of clear, consistent, and accurate emergency communications for tornadoes. Especially important is the inclusion of guidance on both alerts and warning information. Alerts, such as the activation of outdoor sirens, are meant to grab people’s attention, whereas warnings provide information on the nature of the emergency and what actions people should take. The provision of warning information along with the siren alerts could have enhanced the public’s understanding of why the sirens were sounding in Joplin. Understanding could also have been enhanced had the public received timely and consistent rather than conflicting information about weather developments before the tornado struck. NIST recommends that the joint efforts described above involve emergency management, the NWS, and the media, to avoid conflicting messaging in emergencies.

Interested Parties: Academia, ICC, National Emergency Management Association, NFPA, NWS, U.S. Department of Homeland Security (DHS)/FEMA

Organization with Lead Responsibility for Implementation: ICC/NFPA

Recommendation 14—

NIST recommends that the full range of current and next-generation emergency communication “push” technologies (e.g., GPS-based mobile alerts and warnings, reverse 9-1-1, outdoor siren systems with voice communication, NOAA weather radios) be widely deployed and utilized, to maximize each individual’s opportunity to receive emergency information and respond safely, effectively, and in a timely fashion.

Justification:

NIST found that people’s responses to the impending storm, in many cases, were delayed or incomplete, which resulted in some fatalities occurring outside, in vehicles, and among individuals rushing to obtain safer refuge when the tornado struck. Among those who did not respond or delayed their response, NIST found that a lack of awareness of the tornado contributed to such behavior. There were individuals within the tornado’s damage path who were unaware of the impending tornado because they did not receive any tornado-related alerts or warnings on May 22, 2011, including individuals with hearing loss, individuals who were asleep before the storm hit, and persons who were disconnected from available modes of emergency communication. Additionally, the use of NOAA weather radios or subscription-based mobile alerting systems was not prevalent among Joplin residents and visitors.

Therefore, NIST recommends that the full range of current and next-generation emergency communication “push” technologies should be evaluated for future use in disseminating alert and warning information. “Push” technologies are those that do not rely on the user to actively search for

information. One example of an alerting push technology is outdoor siren systems. However, in Joplin the siren system was designed to alert only individuals who were located outdoors, even though many individuals could hear these alerts inside their homes and businesses throughout the city. Additionally, no associated warning information was disseminated with these alerts on May 22, 2011, causing individuals to have to search for additional information about the event.

There are new technologies being explored that deliver both alert and warning information based upon geographic location. One of the newest sources of such technology is the Commercial Mobile Alert System (CMAS). CMAS is a partnership between FEMA, the Federal Communications Commission, and wireless carriers, that allows public–safety authorities (either local EMs or the NWS) to send 90–character, geographically targeted, text–like alerts to the public through their mobile devices. Unlike most mobile services, this is not an opt–in system. Rather, individuals with enabled mobile devices who are within a certain distance of activated cell towers will receive the alert messages. These alerts will bypass the regular networks that often bog down due to increased traffic during emergencies.

However, there are limitations associated with this new and exciting technology. For example, notification resources such as cell phones and social networking sites like Twitter have restrictions on the length of individual alert or warning messages. Additionally, individuals who are sleeping still may not receive these types of mobile alerts, especially those in deeper stages of sleep. Therefore, NIST recommends additional exploration of technologies that are able to reach more vulnerable populations in tornadoes, namely those who are sleeping or have visual and/or hearing impairments.

Interested Parties: Academia, DHS/FEMA, Federal Communications Commission (FCC), NOAA/NWS

Organization with Lead Responsibility for Implementation: NOAA

Recommendation 15—

NIST recommends research to identify the factors that will significantly enhance public perception of personal risk and how such knowledge can be better used to rapidly and effectively respond during tornadic events.

Justification:

NIST found that the prevalent “take shelter now” trigger for individuals responsible for their own protective decision–making (e.g., those located at home) in Joplin was the receipt of high–intensity cues, including hearing or seeing the tornado approaching or witnessing others’ urgent efforts to seek protection from the storm. One media source, credited by some with saving lives before the tornado hit, had a broadcast which included a video of the approaching tornado and the station’s newscaster pleading with listeners to “Take cover now!” Both the video and the urgent tone of the broadcaster were highlighted as increasing individuals’ perceived risk associated with the event, prompting them to take action before the tornado hit.

The NWS is currently testing a new method of including stronger–worded text in tornado warning messages for higher–severity storms. However, little research or guidance is available on how to disseminate messages both visually and audibly to increase risk perception. While human factors and

ergonomics research is available on ways of increasing alert or message urgency (e.g., through specific types of tones or voice pacing or frequency), little research or guidance is available on the effectiveness of such technologies in disaster situations. Therefore, research should explore various ways to create and disseminate warnings, as well as to train and educate the public to achieve higher levels of perceived risk among community residents when a tornado is imminent.

Interested Parties: Academia, DHS, ICC, NFPA, NOAA/NWS

Organization with Lead Responsibility for Implementation: NSF, NIST

Recommendation 16—

NIST recommends that tornado threat information be provided to emergency managers, policy officials, and the media on a spatially resolved real-time basis by frequently updating gridded probabilistic hazard information that is merged with other GIS information to supplement the currently deployed binary warn/no warn system.

Justification:

NIST found evidence of high false-alarm rates in Joplin, which were more prevalent among NWS-issued tornado warnings than siren activations. Additionally, NIST found that, prior to the Joplin tornado, there was a pervasive confidence among Joplin residents that a tornado was unlikely to strike their city. One factor that contributed to this confidence was the public's perception of a high number of false alarms in Joplin.

NIST also found that between July 1, 2005 and May 25, 2011, the NWS issued 18 storm-based tornado warnings for all or some part of Joplin. Of these 18 warnings, only 4 were validated by subsequent tornado sightings, which yielded a false-alarm rate for the Joplin area of 78 percent (or 14/18). This rate was similar to the 2007–2011 national average false-alarm rate for NWS storm-based tornado warnings, which was 74.7 percent. Over the most recent 5-year period from 2007 to May 22, 2011, the NWS issued 12 tornado warnings for Joplin, using storm-based warnings, of which only one was verified as an actual storm event. Therefore, during this more recent period, the false-alarm rate for NWS warnings in Joplin had increased to 92 percent.

NIST recommends that the NWS consider improvements to its provision of threat assessments. Rather than the binary warn/no warn system that is currently employed, NIST recommends that the NWS consider moving toward providing frequently updated gridded probabilistic hazard information, which could be merged with other GIS information to provide better hazard information and reduce false-alarm rates.

Interested Parties: NOAA

Organization with Lead Responsibility for Implementation: NOAA

Appendix A

MESOSCALE DISCUSSIONS ISSUED ON MAY 22, 2011, THAT INCLUDED JOPLIN

A.1 MESOSCALE DISCUSSION 853

Source: NOAA (www.spc.noaa.gov/products/md/2011/md0853.html)

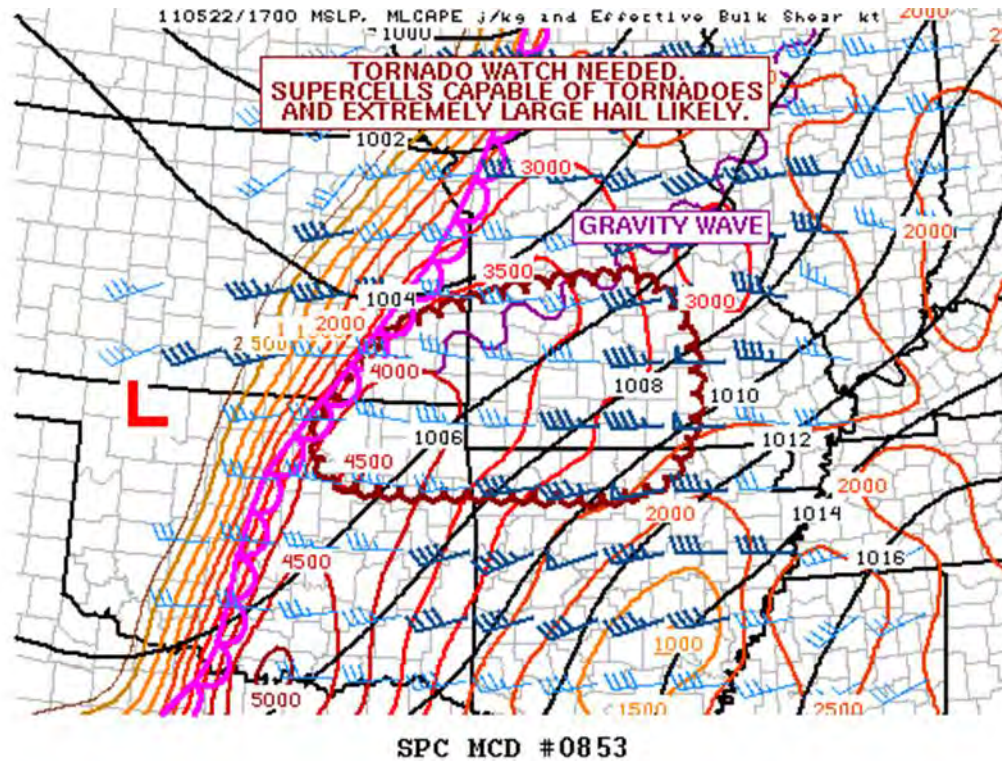

MESOSCALE DISCUSSION 0853
NWS STORM PREDICTION CENTER NORMAN OK
0106 PM CDT SUN MAY 22 2011

AREAS AFFECTED...ERN KS...NERN OK...MUCH OF SRN AND SWRN MO...NRN AR
CONCERNING...SEVERE POTENTIAL...TORNADO WATCH LIKELY

VALID 221806Z - 222000Z

A TORNADO WATCH WILL BE ISSUED SHORTLY.

AN EXTREMELY UNSTABLE AIR MASS HAS DEVELOPED E OF THE DRYLINE WITH DEWPOINTS NEAR 70 F BENEATH STEEP MID LEVEL LAPSE RATES. NEARLY ALL CONVECTIVE INHIBITION HAS BEEN ERODED...THUS EXPECTED CU ALONG THE DRYLINE TO ERUPT INTO INTENSE SUPERCELLS. EXTREMELY LARGE HAIL IS

LIKELY...AND ALTHOUGH LOW LEVEL SHEAR IS A BIT MARGINAL...IT WILL BE MORE THAN SUFFICIENT FOR TORNADES GIVEN EXTREME INSTABILITY.

..JEWELL.. 05/22/2011

ATTN...WFO...LSX...LZK...SGF...EAX...TSA...ICT...

LAT...LON 36619153 36159187 36009275 36049408 36049519 36099643
 36459673 36859655 37749573 38249409 38389294 38389201
 37969159 37169139 36619153

A.2 MESOSCALE DISCUSSION 862

Source: NOAA (www.spc.noaa.gov/products/md/2011/md0862.html)

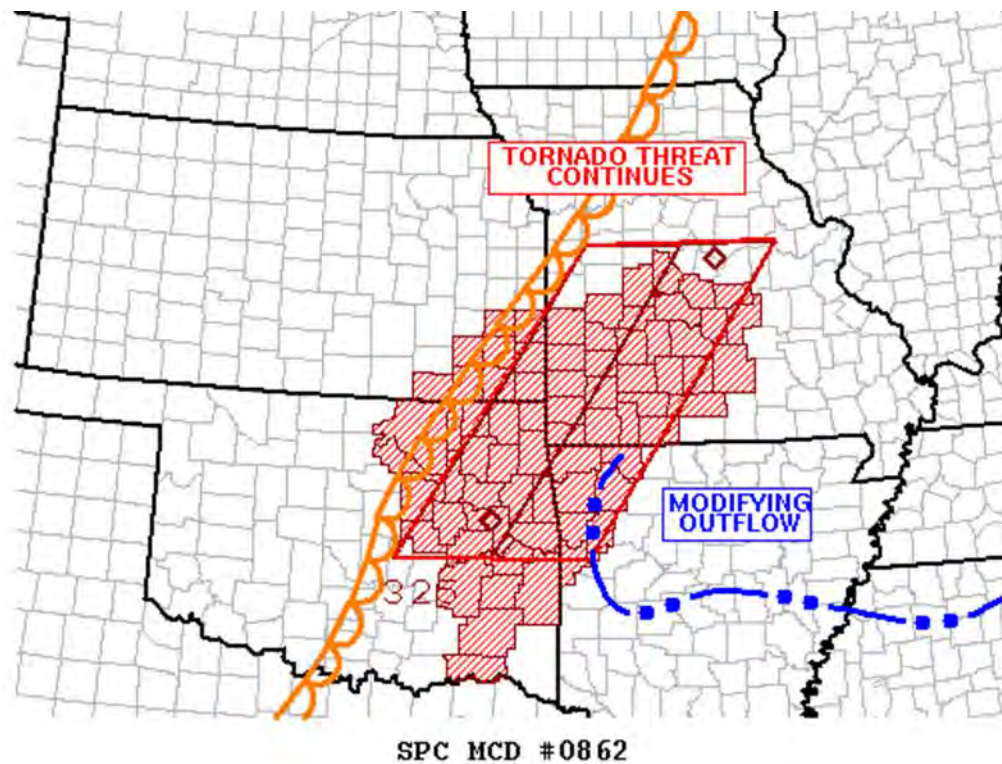

MESOSCALE DISCUSSION 0862
 NWS STORM PREDICTION CENTER NORMAN OK
 0348 PM CDT SUN MAY 22 2011

AREAS AFFECTED...ERN OK...SERN KS...SWRN MO

CONCERNING...TORNADO WATCH [325](#)...

VALID 222048Z - 222245Z

THE SEVERE WEATHER THREAT FOR TORNADO WATCH 325 CONTINUES.

VIGOROUS CONVECTION CONTINUE TO INTENSIFY ALONG THE DRYLINE FROM WRN

MO INTO SERN KS. A MODIFIED 19Z SGF SOUNDING USING OBSERVED SURFACE OBSERVATIONS ALONG THE DRYLINE YIELDS OVER 5000 J/KG MUCAPE WITH A 300 MB LI OF -19C. ALSO DEPICTED IN THIS SOUNDING...AND ON NDS AND CNW PROFILERS...IS 40-50 KT MID LEVEL FLOW ATOP VEERING LOW LEVEL FLOW...MORE THAN SUFFICIENT FOR SUPERCELLS. EXISTING STORMS WILL PERSIST WITH AN EXTREME HAIL THREAT AS WELL AS THE POSSIBILITY OF CYCLIC TORNADOES.

TO THE S...A SUBSTANTIAL CU FIELD REMAINS OVER NERN OK...AND SWD ACROSS ERN OK WHERE DEWPOINTS ARE IN EXCESS OF 72 F. HERE...SBCAPE IS AVERAGING 5500-6000 J/KG. HKL AND PRC PROFILERS ALSO INDICATE INCREASING MID TO UPPER LEVEL FLOW TO 50-60 KTS ABOVE 9 KM. STRONG HEATING PERSISTS NEAR THE DRYLINE...ALTHOUGH CONVERGENCE IS WEAK. TOWERING CU PERSIST ALONG THE DRYLINE. ANY ROBUST STORMS THAT DO FORM WILL CERTAINLY PRODUCE VERY LARGE HAIL AND HAVE A THREAT OF TORNADOES.

..JEWELL.. 05/22/2011

ATTN...WFO...LSX...LZK...SGF...EAX...TSA...ICT...OUN...

LAT...LON 35239402 35239668 38769406 38759127 35239402

A.3 MESOSCALE DISCUSSION 867

Source: NOAA (www.spc.noaa.gov/products/md/2011/md0867.html)

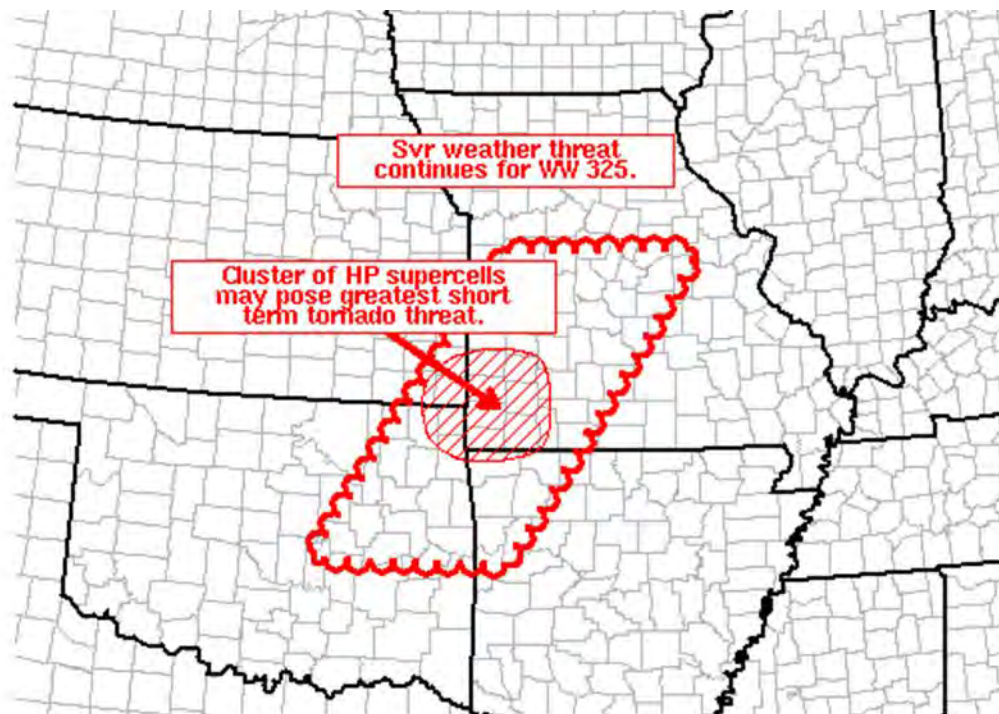

SPC MCD #0867

MESOSCALE DISCUSSION 0867
NWS STORM PREDICTION CENTER NORMAN OK
0610 PM CDT SUN MAY 22 2011

AREAS AFFECTED...CNTRL/SWRN MO...SERN KS...NWRN AR...NERN OK

CONCERNING...TORNADO WATCH [325](#)...

VALID 222310Z - 230015Z

THE SEVERE WEATHER THREAT FOR TORNADO WATCH 325 CONTINUES.

AT 2245-23Z...REGIONAL AND HI-RES RADAR IMAGERY SHOW A CLUSTER OF HP SUPERCELLS MOVING E-SE AT AROUND 30 KT. MOST SIGNIFICANT STORM /WITH A HISTORY OF PRODUCING A TORNADO/ IN THIS CLUSTER WAS LOCATED NEAR JOPLIN AT 2248Z. SGF VWP SHOWS ENLARGED LOW-LEVEL HODOGRAPH STRUCTURE...WITH 0-1 KM SRH NEAR 200 M2 S-2. GIVEN STRONG SHEAR PROFILES RESIDE DOWNSTREAM OVER SWRN MO...ALONG WITH AXIS OF MLCAPE VALUES FROM 2500-4000 J/KG...TORNADO THREAT /POTENTIALLY STRONG/ ALONG WITH VERY LARGE HAIL SHOULD PERSIST AS HP SUPERCELL CLUSTER MOVES ACROSS THE REMAINDER OF SWRN MO. FARTHER N OVER CNTRL MO...CLUSTER OF STORMS WAS MOVING E ACROSS AN ENVIRONMENT CHARACTERIZED BY STRONG INSTABILITY AND FAVORABLE SHEAR PROFILES FOR SUPERCELLS POSING A THREAT FOR TORNADOES...LARGE HAIL AND DAMAGING WINDS.

MEANWHILE OVER NERN OK...SUSTAINED STORM DEVELOPMENT APPEARS TO BE TAKING PLACE BASED ON RECENT REGIONAL REFLECTIVITY. WITH SURFACE CONDITIONS CHARACTERIZED BY TEMPERATURES IN THE MID 80S AND DEWPOINTS IN THE LOW 70S...AND 700-500 MB LAPSE RATES AROUND 7 C/KM...EXTREME INSTABILITY RESIDES AHEAD OF THIS NEW DEVELOPMENT /MLCAPE VALUES NEAR 4000 J PER KG/. AREA VWP/S AND RUC SOUNDINGS SHOW FAVORABLE WIND PROFILES FOR SUPERCELL DEVELOPMENT AS THIS ACTIVITY MOVES DOWNSTREAM ACROSS NERN OK INTO NWRN AR...WITH THE POTENTIAL FOR VERY LARGE HAIL AND TORNADOES CONTINUING INTO THE EVENING HRS.

OVER S-CNTRL OK...LEFT MOVING SUPERCELL IS RAPIDLY MOVING N TOWARD THE SWRN CORNER OF WW 325. THIS STORM WILL POSE A THREAT FOR LARGE HAIL IF IT PERSISTS INTO E-CNTRL/NERN OK.

..GARNER... 05/22/2011

ATTN...WFO...LSX...LZK...SGF...EAX...TSA...ICT...OUN...

LAT...LON 38779404 38769126 35229404 35229670 38779404

Appendix B

EF–SCALE RATING FOR RANDOM RESIDENTIAL STRUCTURES

Building ID Number ¹⁶⁰	Pictometry Analysis Damage Level ¹	NIST EF Analysis			NIST Wind Field Model	
		Damage Indicator ¹⁶¹ (DI)	Degree of Damage ¹⁶² (DOD)	Estimated Wind Speed (mph)	Estimated Wind Speed (mph)	Closest Grid Point Number
1387	Light	2	1	65	75	2691
1528	Light	2	2	75	100	3712
1957	Light	2	2	79	100	500
3442	Light	2	2/4	85	115	1542
3453	Light	2	1/2	85	90	1504
3914	Light	2	1/2	75	100	1664
4167	Light	2	2/4	85	130	1855
5841	Light	2	1	65	90	1326
6350	Light	2	2/4	85	110	1732
8317	Light	2	2	85	110	1744
565	Medium	2	4	90	90	1908
1313	Medium	2	2	80	100	1489
2357	Medium	2	2/4	85	155	858
2674	Medium	2	2/4	85	135	1099
3009	Medium	2	4	100	105	1221

¹⁶⁰ Data Source: Pictometry®. Used with Permission.

¹⁶¹ DI 2 description: One–and Two–Family Residences (TTU, 2006).

¹⁶² Degree of Damage descriptions for DI 2 (TTU, 2006):

DOD Description

- 1 Threshold of visible damage
- 2 Loss of roof covering material (<20%), gutters and/or awning; loss of vinyl or metal siding
- 3 Broken glass in doors and windows
- 4 Uplift of roof deck and loss of significant roof covering material (>20%); collapse of chimney; garage doors collapse inward; failure of porch or carport
- 5 Entire house shifts off foundation
- 6 Large sections of roof structure removed; most walls remain standing
- 7 Exterior walls collapsed
- 8 Most walls collapsed, except small interior rooms
- 9 All walls
- 10 Destruction of engineered and/or well–constructed residence; slab swept clean

Building ID Number ¹⁶⁰	Pictometry Analysis Damage Level ¹	NIST EF Analysis			NIST Wind Field Model	
		Damage Indicator ¹⁶¹ (DI)	Degree of Damage ¹⁶² (DOD)	Estimated Wind Speed (mph)	Estimated Wind Speed (mph)	Closest Grid Point Number
4254	Medium	2	4	95	140	1896
5540	Medium	2	4/6	110	110	528
6002	Medium	2	6	120	135	1412
6188	Medium	2	4	95	130	1613
7101	Medium	2	2/4	90	80	4943
1761	Heavy to Totaled	2	6	115	140	4147
2831	Heavy to Totaled	2	4/6	95	135	1139
2874	Heavy to Totaled	2	4	115	170	1136
3948	Heavy to Totaled	2	4	115	105	1704
4954	Heavy to Totaled	2	4/6	105	160	2823
5075	Heavy to Totaled	2	6	130	165	173
5121	Heavy to Totaled	2	6	125	170	92
5364	Heavy to Totaled	2	6	125	105	207
5570	Heavy to Totaled	2	6	122	125	650
5797	Heavy to Totaled	2	6/7	125	170	1293
1403	Demolished	2	6	130	170	3106
1580	Demolished	2	6	120	160	3788
3559	Demolished	2	6/7	130	170	1495
3683	Demolished	2	8/9	155	165	1619
3781	Demolished	2	6	130	170	1656
4321	Demolished	2	8/9	160	170	2020
4672	Demolished	2	9	175	170	2584
5502	Demolished	2	9	175	170	374
5888	Demolished	2	4	110	170	1415
7181	Demolished	2	8	155	170	4776

Appendix C

MODEL GRID COORDINATES

Figure 2–16 illustrates grid points spaced 0.05 miles (264 ft, 80 m) apart throughout Joplin. Each grid point (X, Y) was given corresponding latitude and longitude values based on the beginning of the tornado track (tornado center). This location was different than the initial tornado touchdown location. In projected coordinates (North American Datum (NAD) 1983 – Missouri West Federal Information Processing Standard (FIPS) 2403 – Feet) used in the ArcGIS layer, the initial tornado center corresponds to $(X_c, Y_c) = (2770845 \text{ ft}, 323676 \text{ ft})$. In latitude and longitude these coordinates are $(X_c, Y_c) = (37.0557, -94.5612)$, i.e., 37.0557 degrees North, 94.5612 degrees West. The values of X_c and Y_c were set as $X = 0$ miles and $Y = 0$ miles in the computer program responsible for translating the tornado through the grid. Although the tornado was initialized at $X = 0$ ($X = 2770845$), the X value corresponding to the first set of grid points was set at $X = 0.65$ miles (or $X = 2770845 + (0.65)(5280) = 2774277 \text{ ft}$). This X value corresponds approximately to Schifferdecker Avenue. The choice of this particular value of X to start the grid points was based on using aerial photos to estimate when the tornado became one entity (i.e., multiple vortices not apparent) based on tree fall patterns. For ease of explanation, the X and Y values used in this section will be referenced from $X = 0$ miles and $Y = 0$ miles.

This page intentionally left blank.

Appendix D

TORNADO WIND FIELD MODEL

The main effects plots (see example in Figure D–1) show how the average output parameter varies given certain input parameters. So, for example, if three values of α are tested (25, 50, and 75 degrees for example), the main effects plot would show the average values of some output parameter (e.g., DR) given those three values. From the main effects plot, therefore, it is possible to determine how much of an effect varying an input parameter has on an output parameter.

The interaction effects plots (example in Figure D–1) illustrate the effects that various combinations of (interactions among) input parameters have on output parameters. For example, the three α values mentioned above could be compared to the DR values that result when a specific RMW value is used.

From Figure D–1, it is possible to infer which specific input parameters have significant influence over the output parameters. For tree fall direction (β), all input parameters have effects on its value. These effects are denoted by the slopes of the main effects plot (Figure D–1, top). For example, increasing the G_{max} parameter induces, on average, a clockwise rotation of the angle β , while decreasing α also causes a clockwise rotation of β . By using the interaction effects plot (Figure D–1, bottom), specific values of an input parameter can be eliminated quickly, provided there is high confidence regarding the value of an output parameter. For example, if DR is observed to be around 2.0, the value of α is likely around 20 degrees. The DR value given $\alpha = 20$ degrees remains consistent even when varying the other input parameters (e.g., changing RMW from 0.10 miles to 0.20 miles does not significantly affect DR). Therefore, DR is a strong predictor of α .

The initial ranges of all Rankine vortex input parameters, mentioned earlier, were narrowed to smaller ranges based on graphically comparing the observed output parameters at selected locations (Table 2–4) with the model outputs at these locations using the interaction effects plot (e.g., Figure D–1). Input values that clearly did not correspond with the observed and model output values were eliminated. Uncertainty in the observations in Table 2–4 was also taken into consideration when selecting the narrower ranges. These narrower ranges (shown in Table D–1) were then used as “best matches” of input parameters to the observations and as final inputs for the wind field model through a second full factorial design.

Table D–1 shows the final input parameter ranges used for the analysis. Mile points (X values) shown reflect either a change in θ_7 or change in RMW . As estimated by tree fall, except in the early stages of the tornado, the Rankine vortex parameter ranges remained the same. This suggests that the tornado maintained its size and intensity throughout the city of Joplin. Initial values of RMW were kept fixed (before grid development) to generate a match to observed DW and DR values from mile points $X = 0.69$ to 1.22, shown in Table 2–4. The best estimated values for the Rankine vortex model were assumed to be in the center of the input parameter ranges (e.g., $\alpha = 20$ degrees).

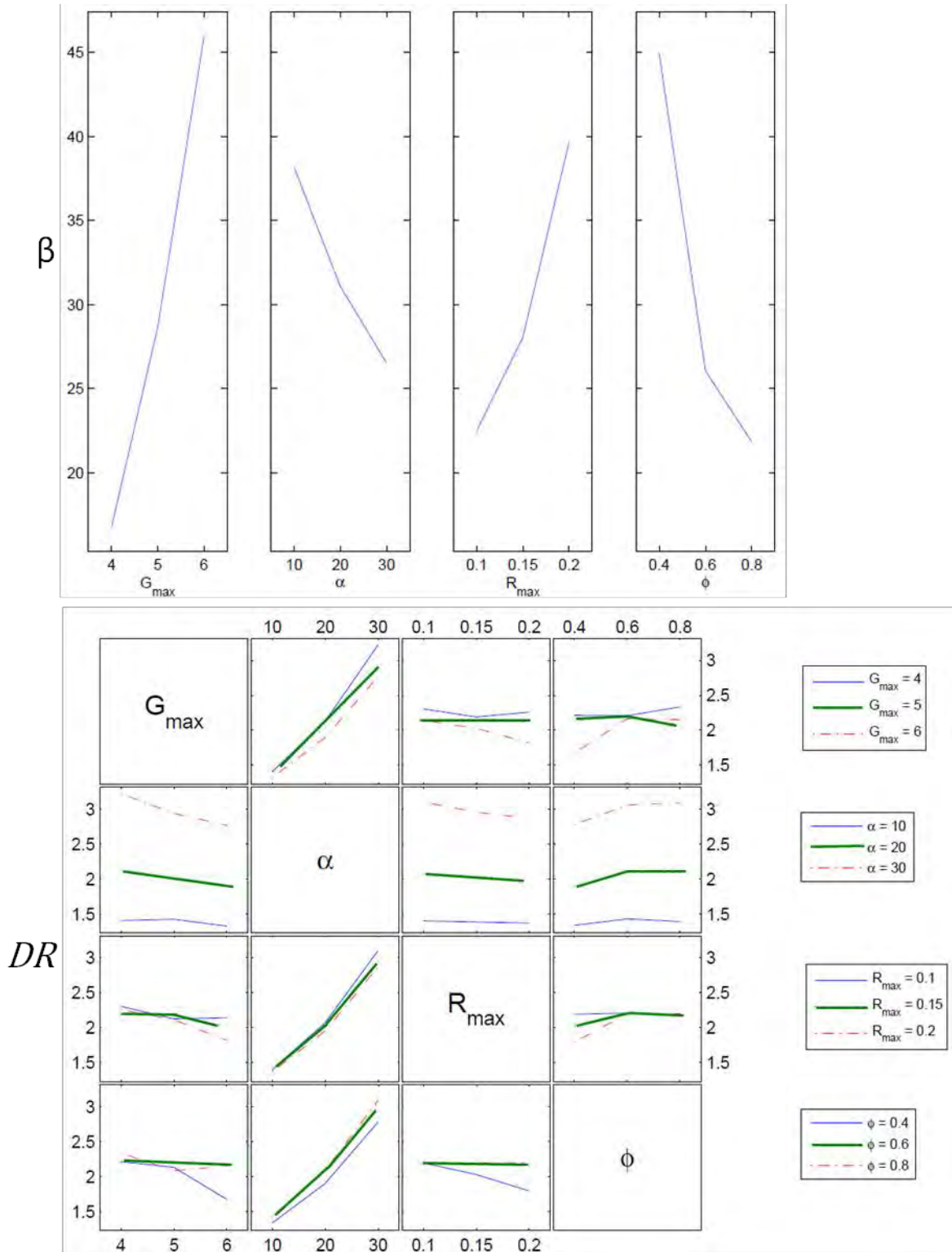

Figure D-1. Main (top) and interaction (bottom) effects plots for input and output parameters.

Table D–1. Final input parameter ranges.

Mile Point (X)	Radius of Maximum Wind (RMW) (miles)	Phi	G_{max}	Alpha (degrees)
0.00	0.07	0.6–0.7	4.5–5.0	15–25
0.33	0.10	0.6–0.7	4.5–5.0	15–25
0.52	0.11	0.6–0.7	4.5–5.0	15–25
0.65	0.12	0.6–0.7	4.5–5.0	15–25
1.22	0.12–0.14	0.6–0.7	4.5–5.0	15–25
2.10	0.14–0.18	0.6–0.7	4.5–5.0	15–25
2.68	0.14–0.18	0.6–0.7	4.5–5.0	15–25
3.14	0.14–0.18	0.6–0.7	4.5–5.0	15–25
3.69	0.14–0.18	0.6–0.7	4.5–5.0	15–25
5.18	0.14–0.18	0.6–0.7	4.5–5.0	15–25
6.01	0.14–0.18	0.6–0.7	4.5–5.0	15–25
6.47	0.14–0.18	0.6–0.7	4.5–5.0	15–25
6.77	0.14–0.18	0.6–0.7	4.5–5.0	15–25

This process will now be explained for a specific area in Joplin. This area is defined as $X = 2.1$ miles ($X = 2.1$ miles in projected coordinates) and all Y values associated with that specific X value. This area is “boxed” in Figure D–2. Near $X = 2.1$ miles and all associated Y locations, DW was observed to be approximately 0.9 miles and DR was estimated to be around 2.0, as shown in Table 2–4. For this example the ranges in Table D–1 were used in the factorial design. For example, only $G_{max} = 4.5$ and $G_{max} = 5.0$ were used. This example then has 64 different combinations ($2 G_{max}$, $2 RMW$, 2ϕ , 2α , $2 V_{crit}$, and $2 V_T$; $2^6 = 64$) of parameters at $X = 2.1$ miles. This means that there are 64 different wind speed and direction time histories at each grid point and 64 total pairs of DW and DR values for the set of points corresponding to $X = 2.1$ miles. As an example, histograms of the 64 values of DW and DR are shown in Figure D–3. Values shown in Figure D–3 are within the bounds of the observed (i.e., estimated) DW (0.9 miles) and DR (2.0) at this location, suggesting that an acceptable range of parameters was used in the factorial design.

The observed DW and DR for this location ($X = 2.1$ miles) are compared to the interaction plots shown in Figure D–4. Starting from the top left and the G_{max} parameter, it is evident that regardless of interactions with other input parameters in the Rankine vortex, higher G_{max} values lead to higher values of DW . Higher DW values would be expected since a higher G_{max} leads to higher values of wind speed. Considering interactions, higher values of RMW (R in Figure D–4) coupled with higher values of G_{max} leads to high DW values. This interaction is opposite when considering V_{crit} (V_c in Figure D–4), as a lower V_{crit} leads to higher values of DW . This is also expected, as a higher critical tree fall wind speed would cause less tree damage. Changing the α parameter does not affect the values of DW , while increasing ϕ values, which essentially reduces the extent of stronger wind speeds, reduce DW on average. Also, as expected, higher values of V_T lead to higher values of DW . In Figure D–4, as was also shown in

Figure D-1, α almost solely controls the DR values. The slopes are relatively flat for all other Rankine vortex parameters. This general interpretation can be used for all interaction plots, including for Figure D-5, which shows the distance (‘-’ for south, ‘+’ for north, in miles) from the convergence line where estimated tree fall direction (β) was 90 degrees and 180 degrees.

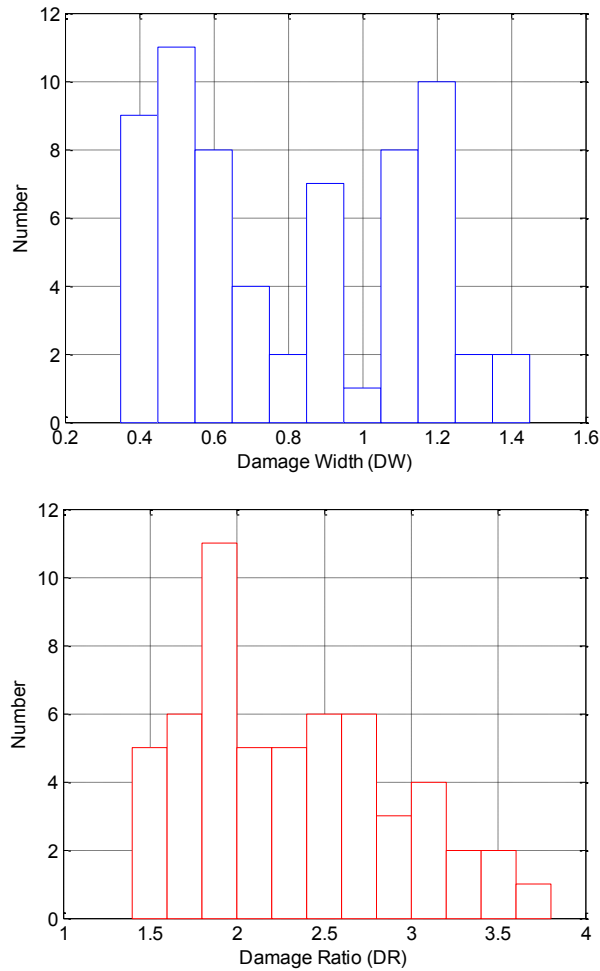

Figure D-2. Histograms showing values of DW and DR for $X = 2.1$ miles.

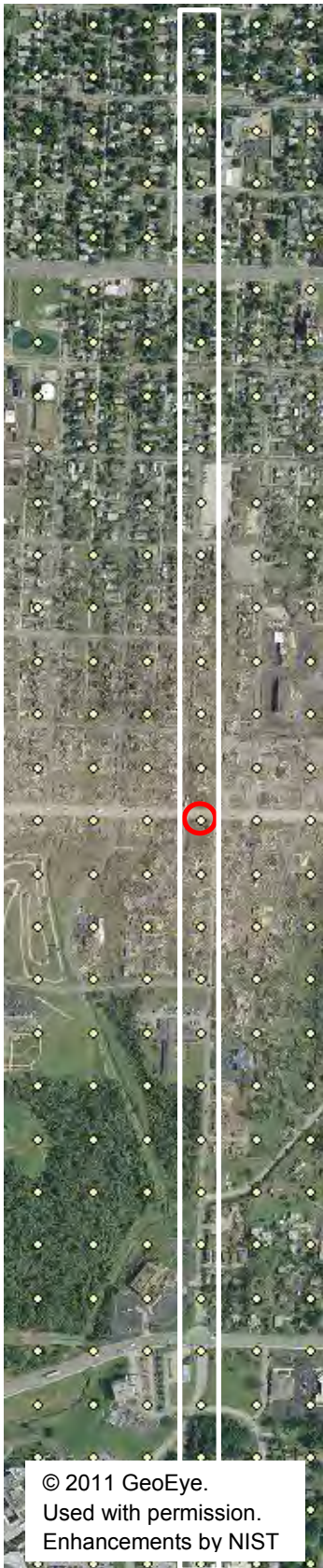

Figure D-3. Area and grid point for detailed factorial design (left)

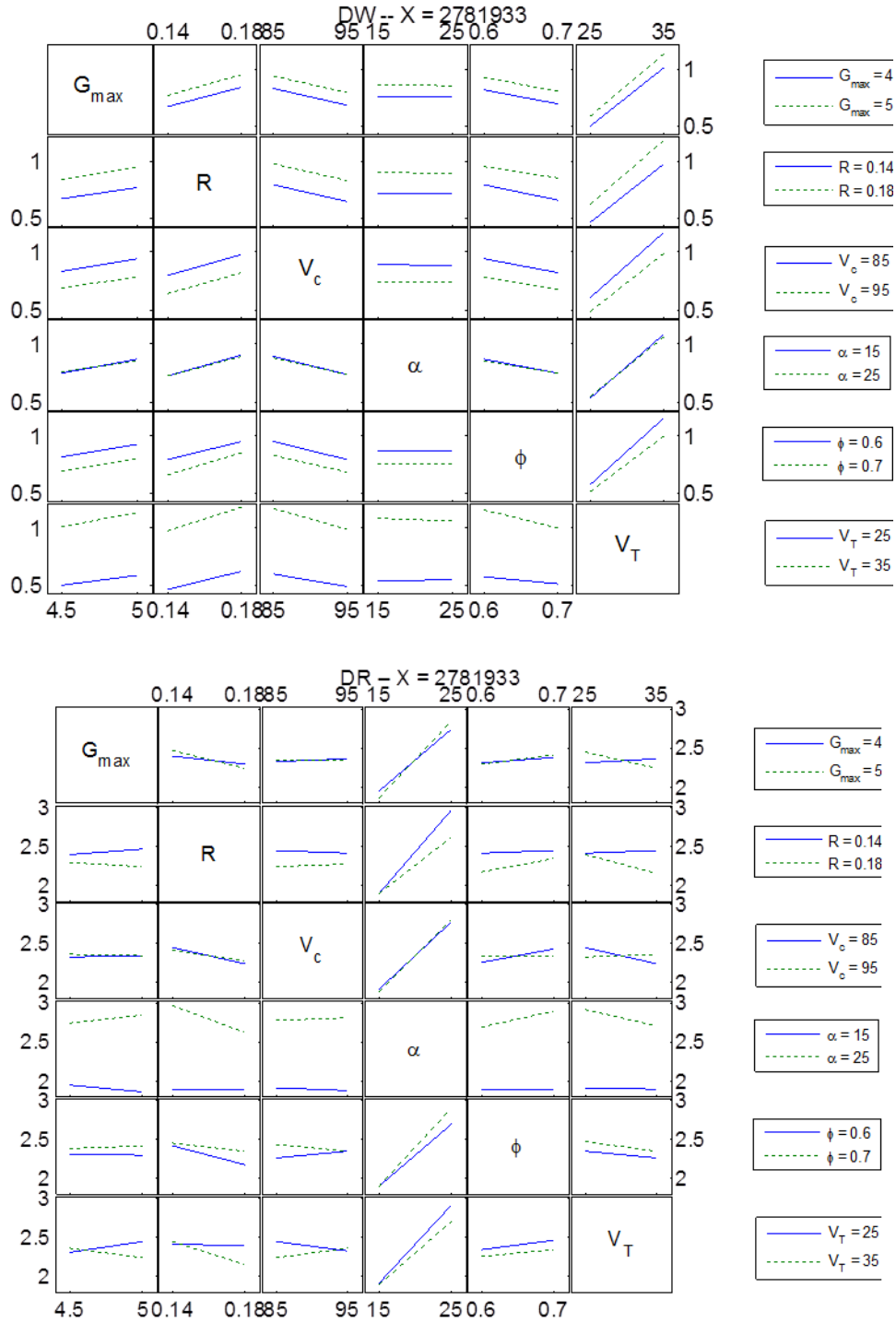

Figure D-4. Interaction effects plots for DW (top) and DR (bottom) for $X = 2.1$ miles.

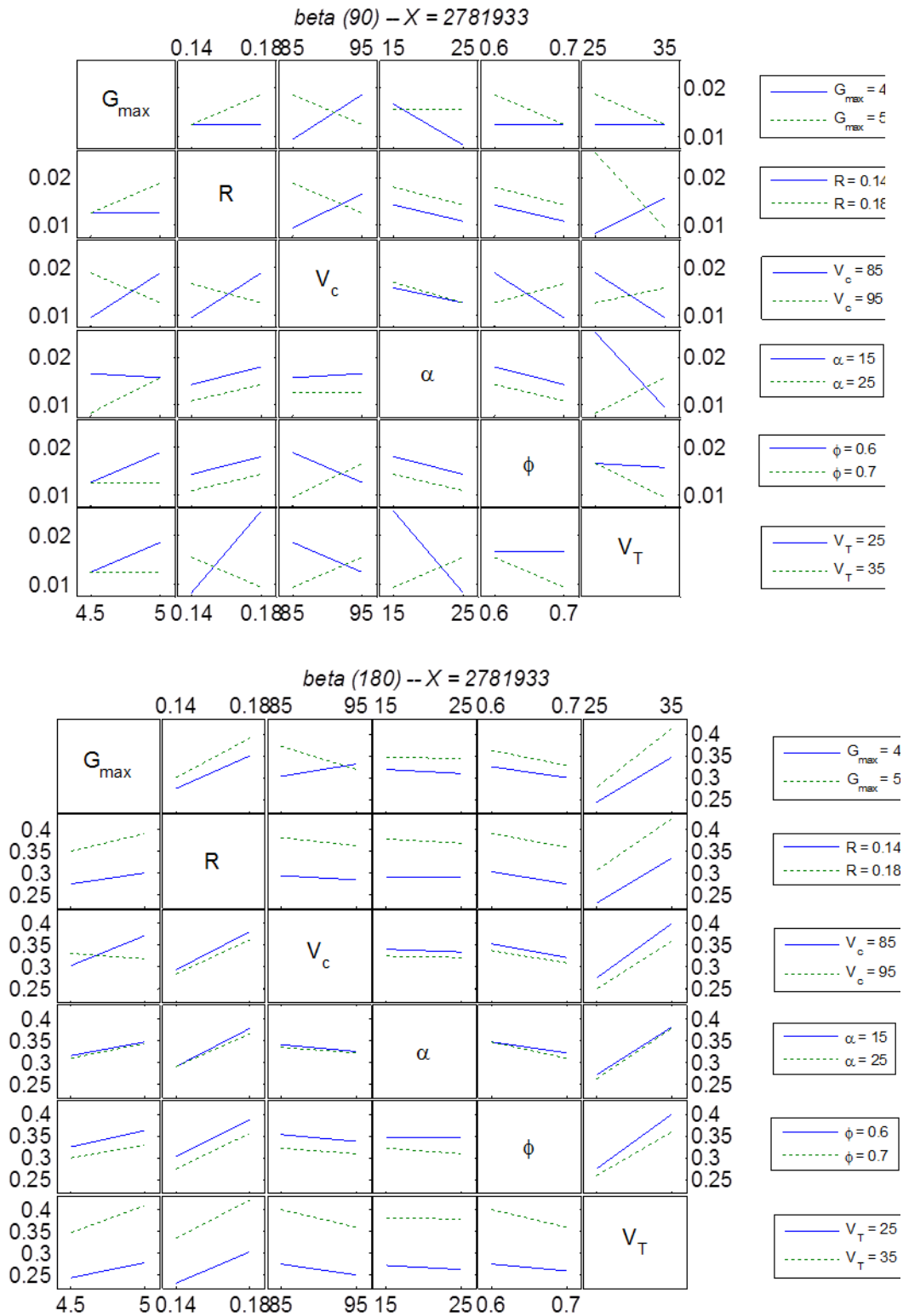

Figure D-5. Interaction effects plots for $\beta = 90$ degrees (top) and $\beta = 180$ degrees (bottom) for $X = 2.1$ miles.

This page intentionally left blank.

Appendix E

MODELED WIND SPEED AND DIRECTION TIME HISTORIES AT SELECT LOCATIONS

Note: The best estimates of time histories for wind speed and direction from the tornado wind field model in this appendix are located nearest the center of the identified building. The complete set of modeled time histories will be available through the NIST Disaster and Failure Event Data Repository web site (http://www.nist.gov/el/disasterstudies/repository_home.cfm) when the Joplin Tornado Repository is completed.

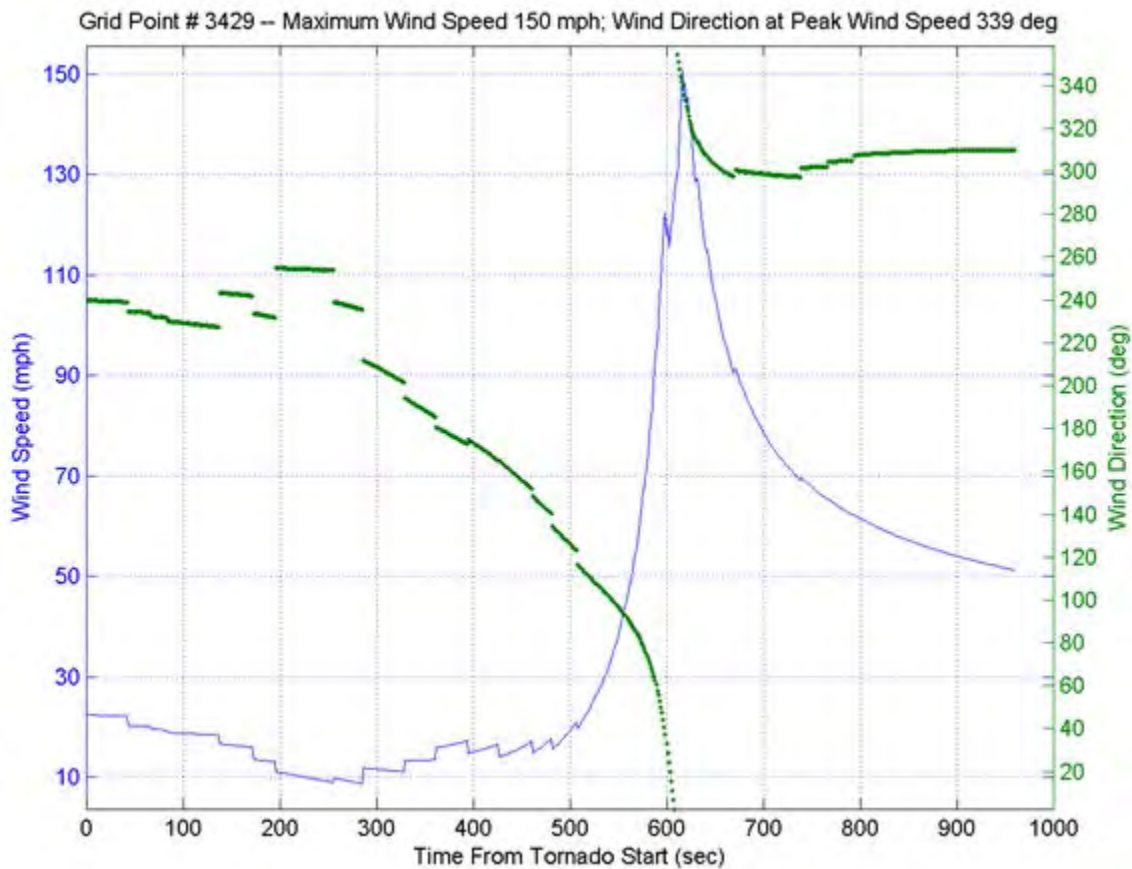

Figure E-1. Time History for Near WalMart (Grid Point # 3429)

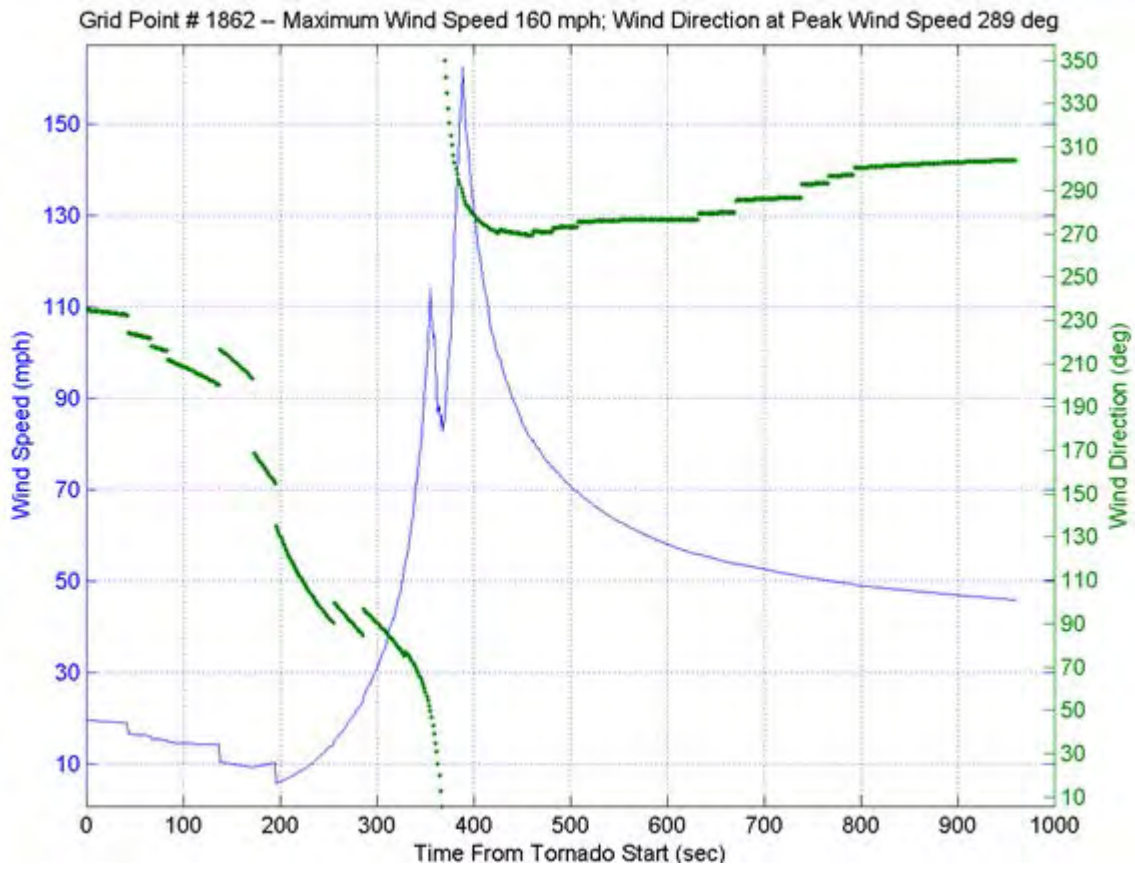

Figure E-2. Time History for Near Franklin Technology Center (Grid Point # 1862)

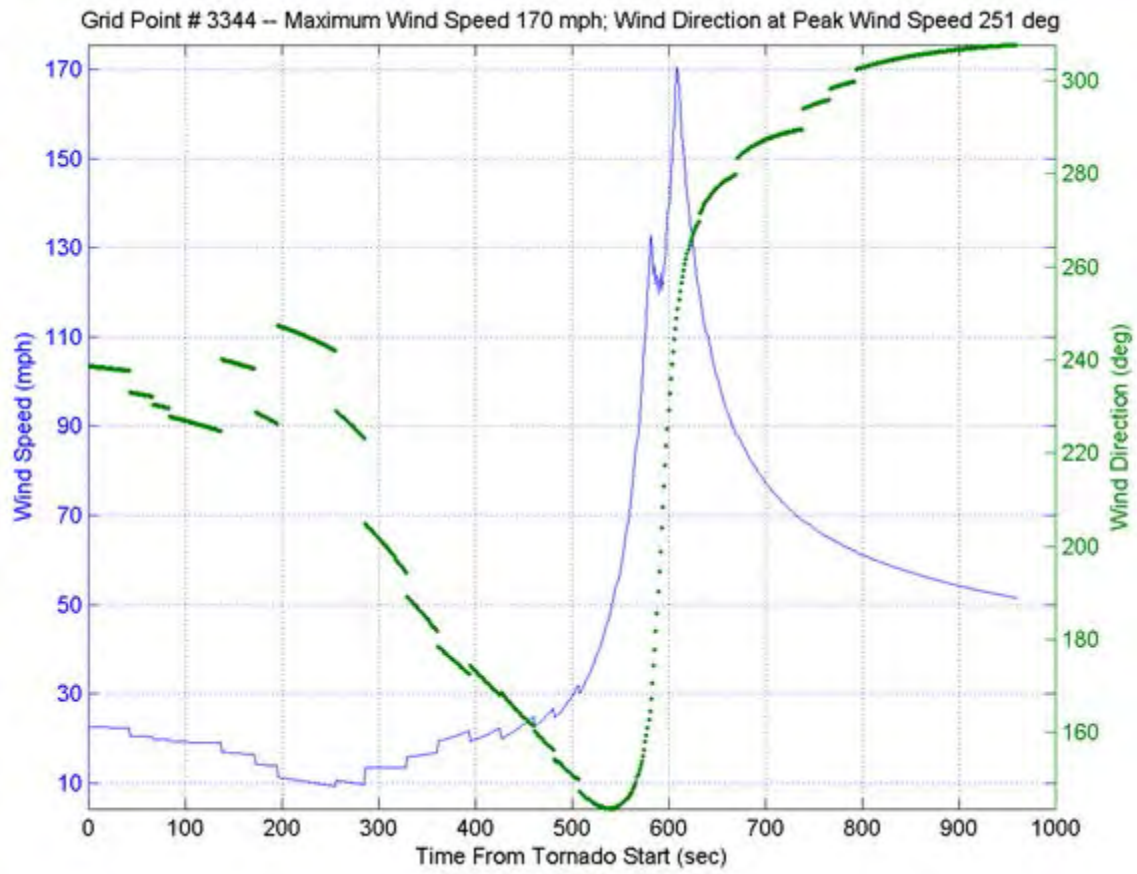

Figure E-3. Time History for Near Home Depot (Grid Point # 3344)

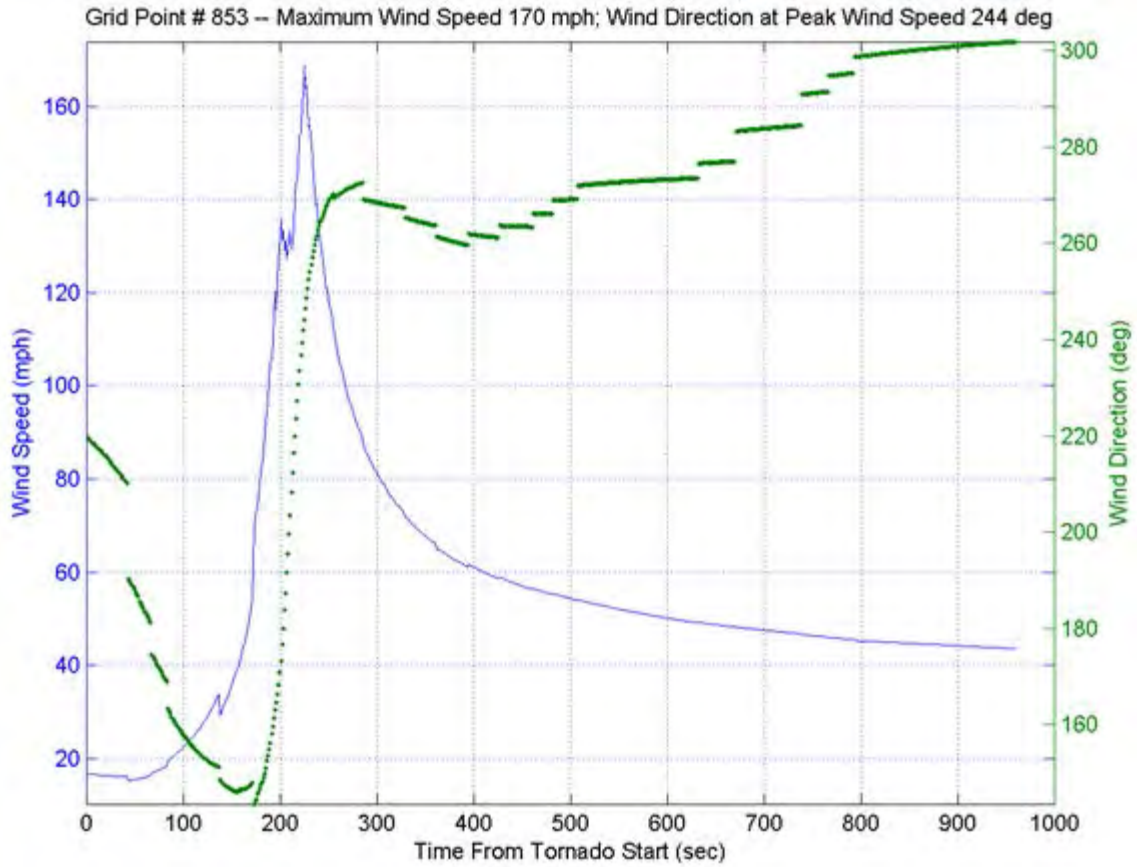

Figure E-4. Time History for Near St. John’s Regional Medical Center –Main Buildings (Grid Point # 853)

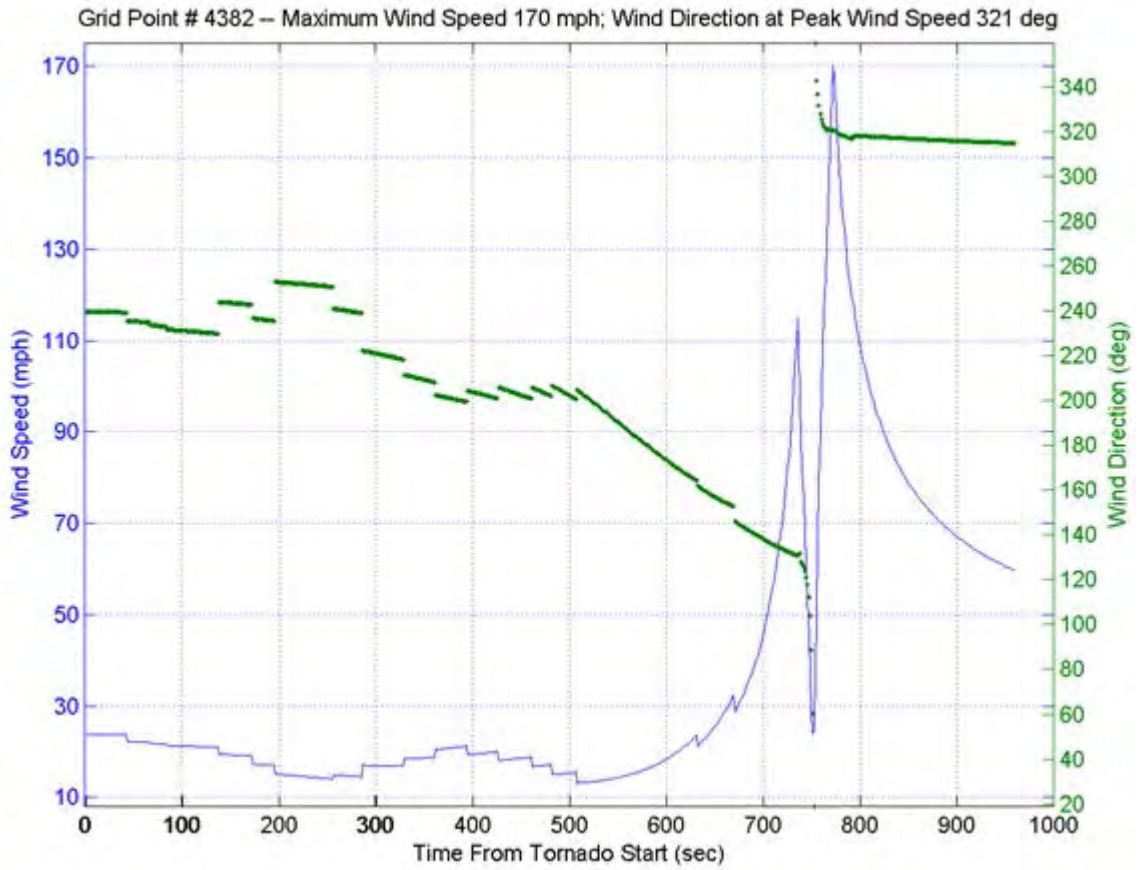

Figure E-5. Time History for Near Joplin East Middle School (Grid Point # 4382)

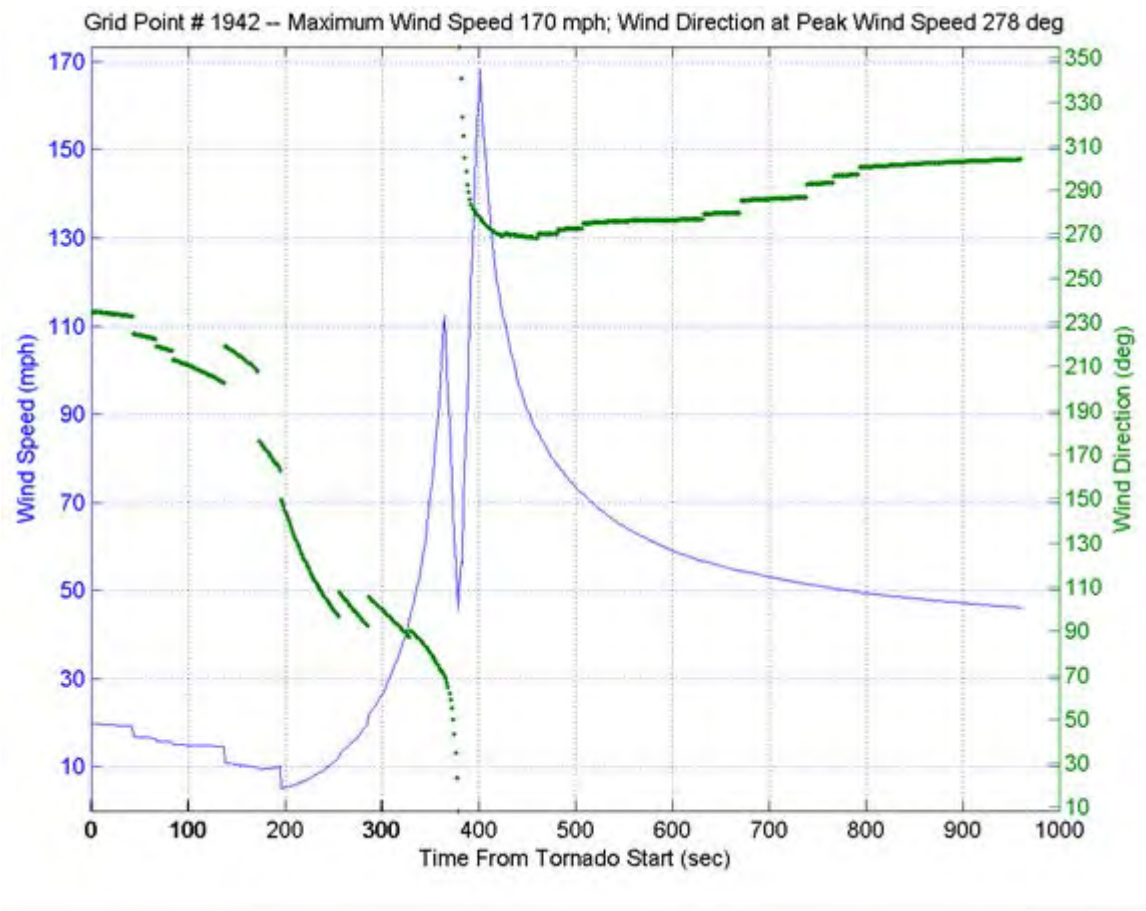

Figure E-6. Time History for Near Joplin High School (Grid Point # 1942)

Appendix F

TORNADOES PER YEAR MAPS (EF-0 THROUGH EF-5)

The values on the maps in this appendix represent the average number of tornado touchdowns of the indicated EF intensity per year that occurred within an 80-mile radius of each grid point (values are centered over grid point locations). This average is for the period of 1950 through 2011, and was constructed using data from the official record of tornado touchdown locations.¹⁶³ If no value appears on the grid, the average number of tornado touchdowns per year is close to zero in that area.

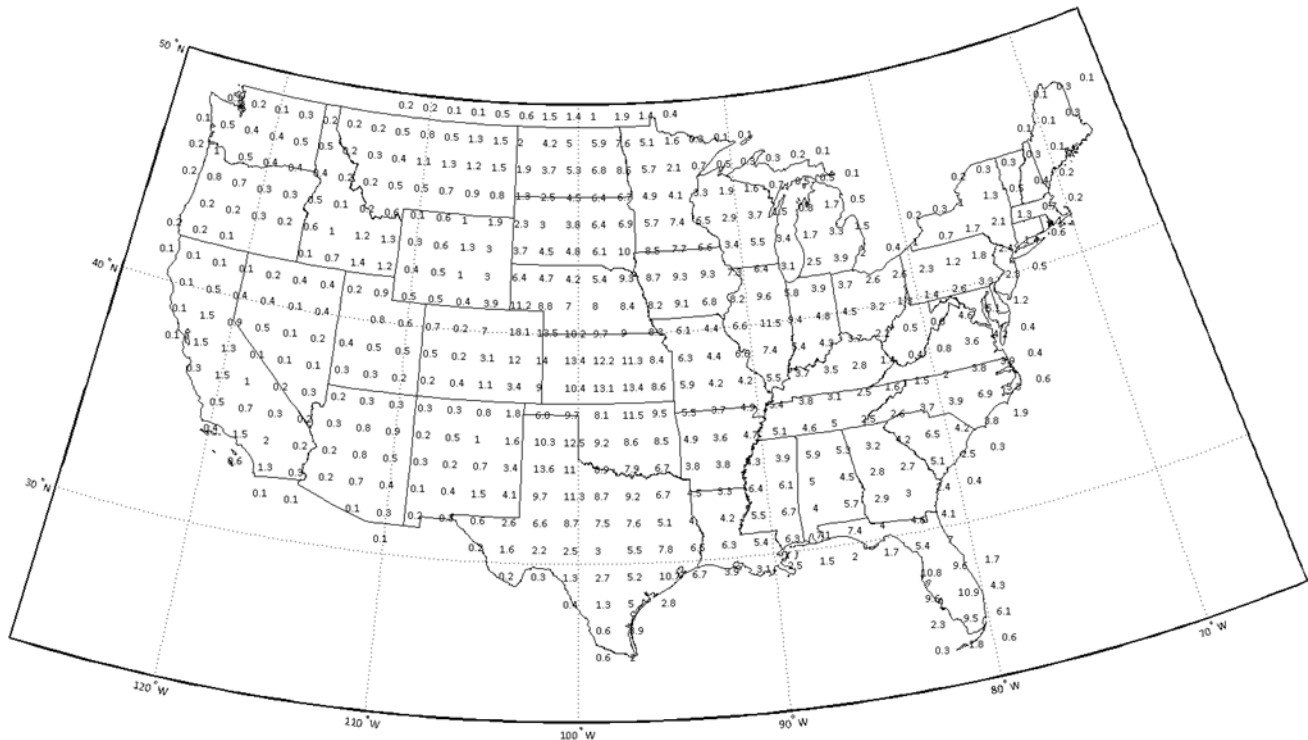

Figure F-1. Map of EF-0 tornadoes per year.

¹⁶³ NOAA (http://www.spc.noaa.gov/wcm/data/1950-2012_torn.csv).

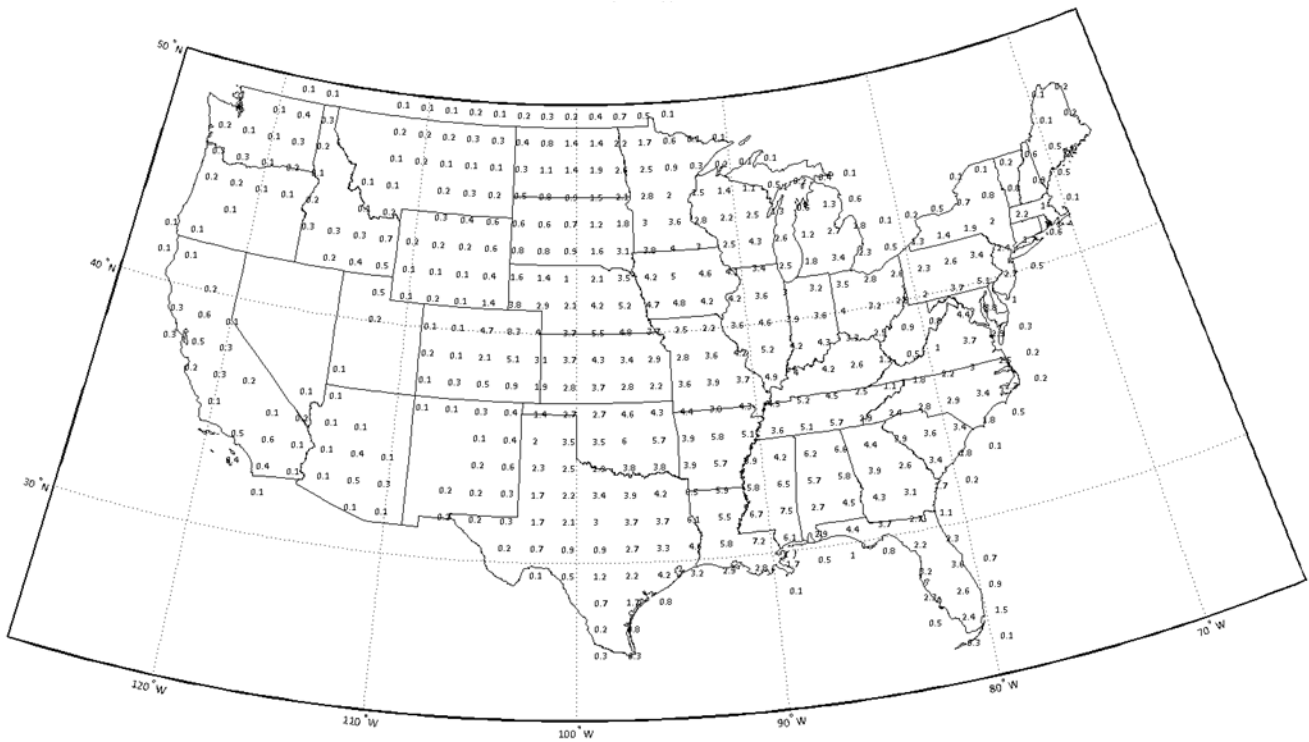

Figure F-2. Map of EF-1 tornadoes per year.

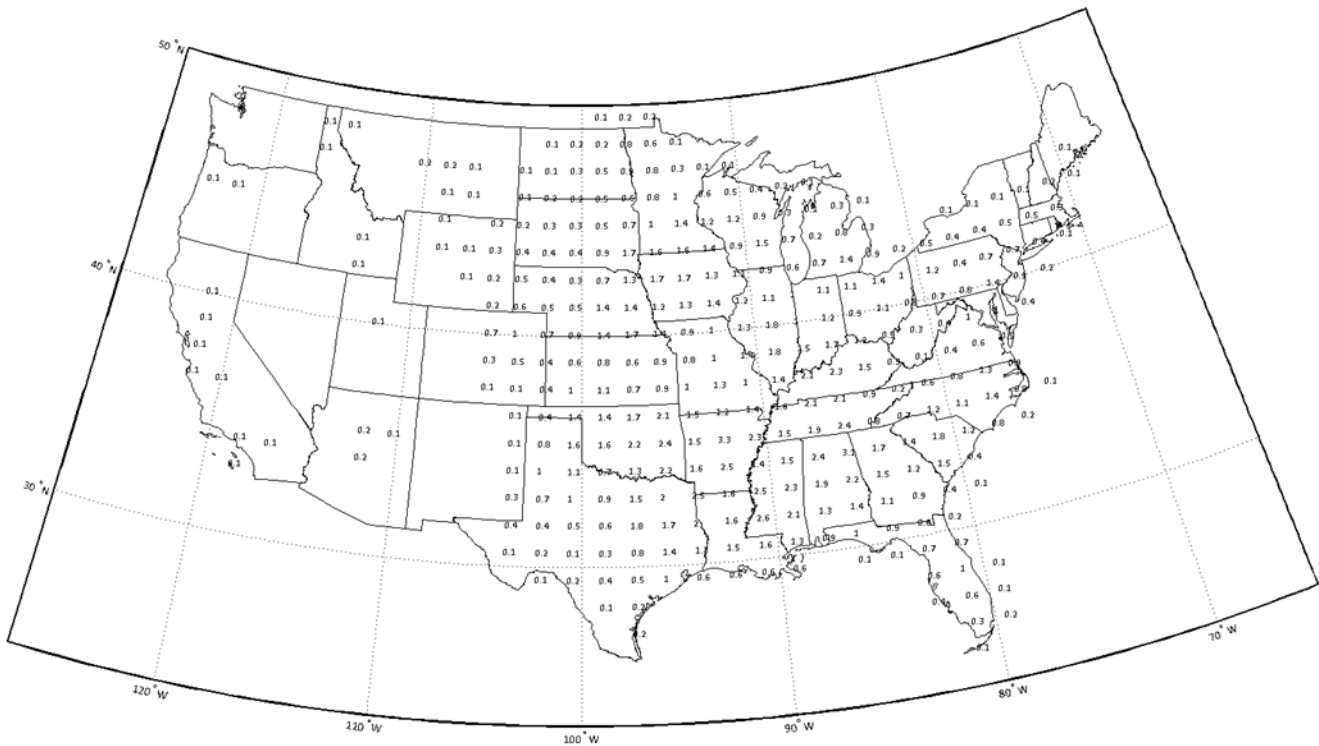

Figure F-3. Map of EF-2 tornadoes per year.

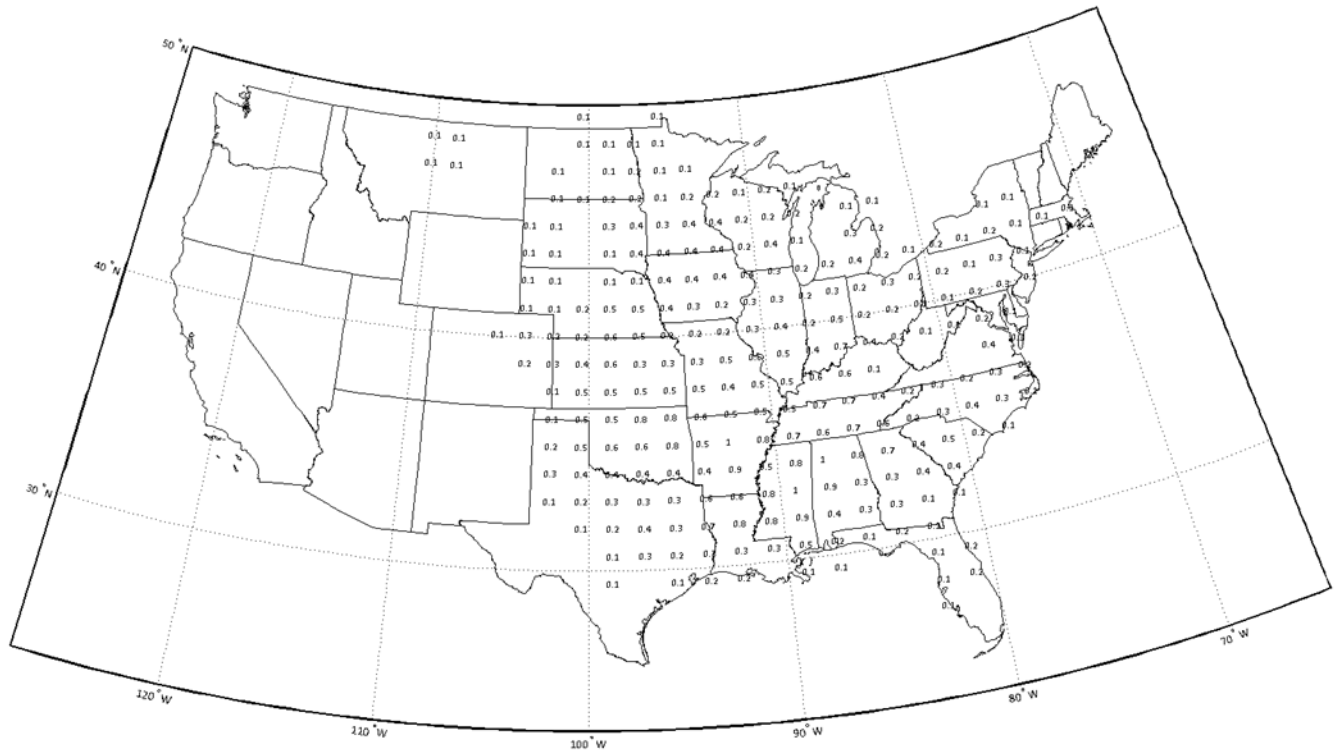

Figure F-4. Map of EF-3 tornadoes per year.

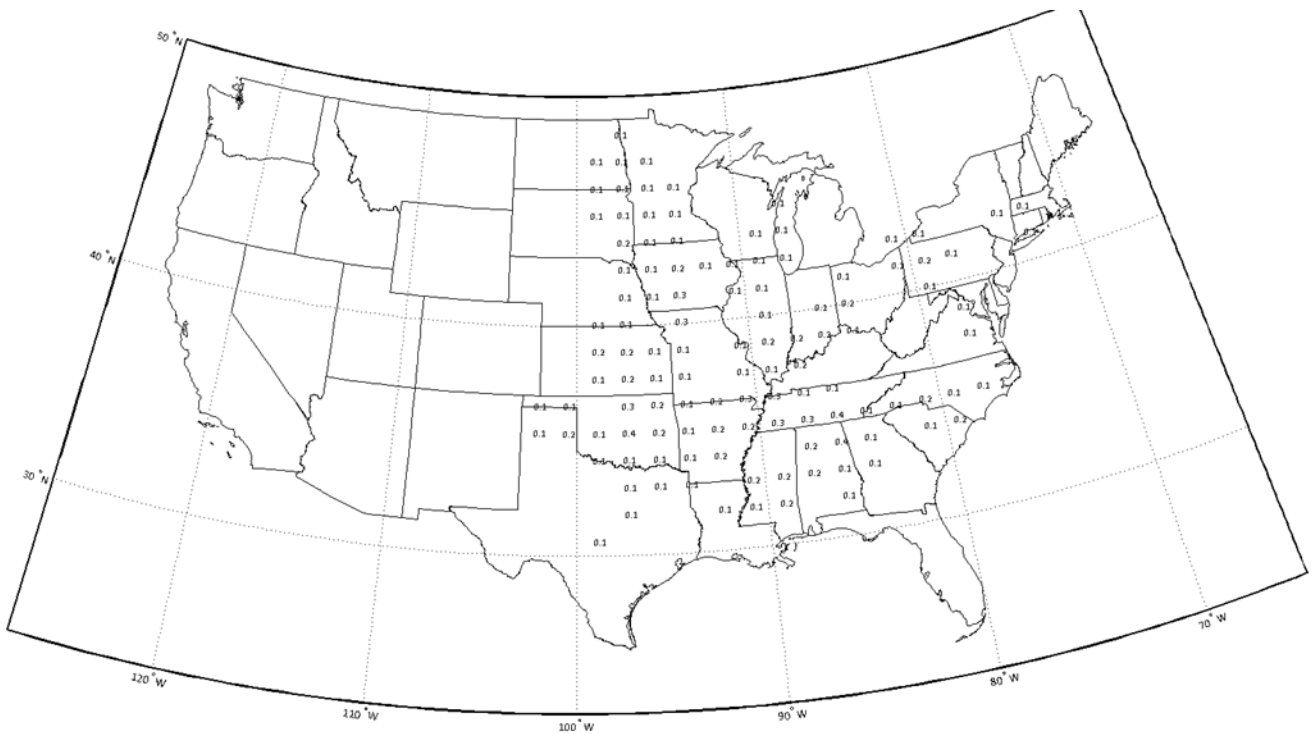

Figure F-5. Map of EF-4 tornadoes per year.

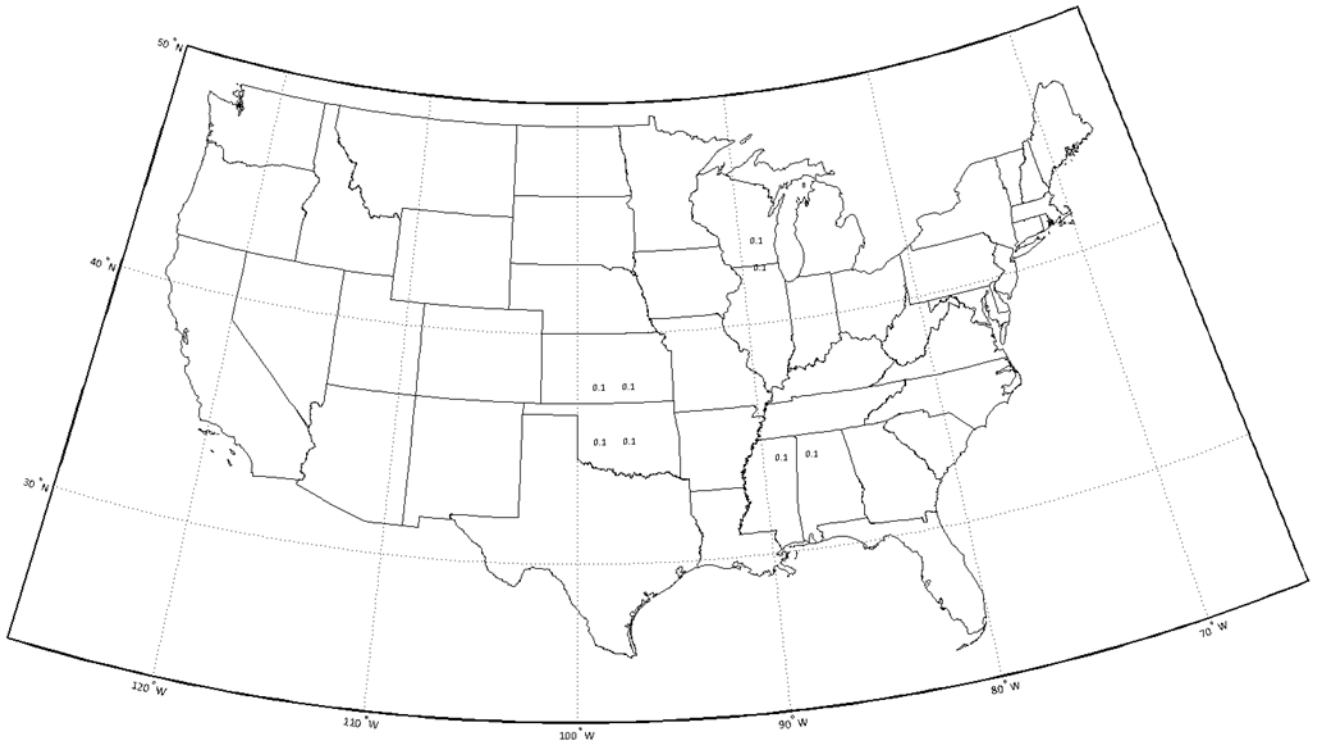

Figure F-6. Map of EF-5 tornadoes per year.

Appendix G

HISTORY OF CODE ADOPTIONS BY THE CITY OF JOPLIN

Table G-1. City of Joplin Code Adoptions¹⁶³

EFFECTIVE DATE	ADOPTED CODE OR LEGISLATION	Ordinance #
February 26, 1877	An ordinance in relation to preventing fires.	12
October 2, 1877	An ordinance in relation to preventing fires. Re: building construction in certain areas of the city.	48
May 29, 1901	Creating the office of plumbing and sanitary inspector and regulating plumbing.	1554
August 9, 1910	An ordinance governing the construction, alteration and repair of gas lines, piped, and valves in buildings and structures.	3941
May 22, 1912	An ordinance fixing the Fire Limits of the City.	4498
September 11, 1912	An ordinance regulating the appointments and providing for the public safety at places of public amusements, including construction, egress, etc.	4574
May 27, 1913	An ordinance creating the office of Electrical Inspector, defining duties and powers thereof, providing regulations for electrical installation and improvements and inspection of same.	4737
January 6, 1914	An ordinance fixing fire limits and regulating construction of buildings in same.	4869
July 3, 1914	Creating a board for the examination of plumbers, and the office of Chief Plumbing Inspector, and penalties for violating this ordinance.	5096
February 9, 1915	Providing for filing of plans and issuing of permits for buildings in the City of Joplin	5361
February 23, 1915	An ordinance providing for the regulation, use, and handling of volatile inflammable fluids.	5374
May 11, 1915	Appropriating funds to pay for electrical inspections.	5468
October 26, 1915	Amending ordinance no 5374 for the regulation, use and handling of flammable fluids.	5771
December 14, 1915	Amending ordinance no 5374 for the regulation, use and handling of flammable fluids.	5830
February 19, 1916	Gas fitting regulations and inspections for the City of Joplin	5913
May 2, 1916	Amending ordinance 5096 by adding "Chief Plumbing Inspector"	6009
August 12, 1919	An ordinance declaring frame buildings located within the fire limits fo the city which are damaged by fire, decay or otherwise to the extent of 30% of their value or in such condition to be dangerous to be a nuisance.	7223
September 27, 1921	An ordinance prescribing certain rules and regulations for the installation of electrical wiring and connections in the City of Joplin	7770
November 25, 1924	Repealing sections of ordinance 6350, and adding sections regarding Plumbers and Plumbing Board of Examiners	8734
April 13, 1926	Creating an office of Electrical Inspector and spelling out duties.	9177
November 13, 1927	Amending sections of the Code of 1917 of City of Joplin relating to plumbing regulations.	10095

¹⁶⁴ © 2008 City of Joplin. Used with Permission.

EFFECTIVE DATE	ADOPTED CODE OR LEGISLATION	Ordinance #
March 6, 1934	An ordinance regulating electrical installation, providing for a board of Arbitration and Examination, and requiring a licens for the business of electrician and permits for electrical installations.	16289
July 24, 1934	Amending ordinance 16289 re: Electrical regulations, inspections, permits and licensing.	16360
February 14, 1939	An ordinance regulating and providing for the inspection of elecrtical work, creating an office of Electrical Inspector, providing for electrical permits and establishing fees.	17465
January 2, 1940	Adopting 1940 City Code of Joplin.	17707
April 30, 1946	Amending ordinance 17707 in regards to salary of the Electrical Inspector	19451
July 9, 1946	An ordinance to provide for the registration of dealers in electrical products and commodities and for the inspection and regulation of same.	19562
August 13, 1948	Amending Ordinance 17707 and adding sections regarding issuance of temporary Master or Journeyman Plumbing certificates.	20453
May 17, 1949	Amending Article 75 of Ordinance No. 17707 providing for the issuance of certificates to master and journeyman plumbers and exams to qualify for the certificates. Creation of a board of examiners. Creation of the office of plumbing inspector. Providing for licensing of contractors and master and employing plumbers that work in the City.	20695
August 30, 1949	Repealing Ordinance No. 20695 and enacting in lieu thereof an ordinance amending Article 75 of Ordinance No.17707. New Sections are enacted and for issuing certificates to master and journeymen plumbers and exams to qualify for the certificates. The creation of the board of examiners. Creation of the office of plumbing inspector. Licensing of plumbing contractors. Providing fees for permits and inspections, and defining the word "plumbing".	20798
November 15, 1949	Providing that the Electrical Inspector may perform the duties of the Plumbing Inspector if he is qualified.	20855
November 27, 1951	Requirements for installation of certain types of gas appliances requiring reports to the city plumbing inspector and prescribing penalty for violation.	21449
August 16, 1954	Creating a Dangerous Building Ordinance	22536
May 10, 1954	Establishing an Electrical Board, providing for terms and members, selection and designation.	22454
October 4, 1954	Establishing license fees for electrical contractors and for electrical inspections amending sections of Ordinance 17707.	22568
October 4, 1954	Establishing liscense fees for master and journeyman plumbers and inspection fees. Amending sections of Ordinance 20798 and 21449.	22570
June 6, 1955	Adopting the 1953 National Electrical Code. The qualifications, duties and authority of the electrical inspector. Listing the duties of the electrical examining board for providing examinations and certificates to electrical contractors and journeyman, also providing licensing fees and standards of work and violation fees. Repealing Ordinances 20855, 22568 and Article 35 Sections of Ordinance 17707.	22675

EFFECTIVE DATE	ADOPTED CODE OR LEGISLATION	Ordinance #
June 6, 1955	Amending ordinance 22454 providing for qualifications of members of the Electrical Board	22676
July 18, 1955	Adopting the 1955 BOCA Building Code with amendments.	22699
December 5, 1955	Amending ordinance 22675 by providing for permit fees on any electrical installation.	22782
January 7, 1957	Adopting as a Basic Plumbing Code chapters 1 to 14, both inclusive and appendices A, B, C, and C of the Report of the Coordinating Committee for a National Plumbing code, Domestic Commerce Series no. 28 issued by the United States Department of Commerce and Housing and Home finance Agency in 1951	23000
January 7, 1957	Adopting the 1956 Fire Prevention Code recommended by the National Board of Fire Underwriters.	23001
June 1, 1959	Adopting the 1957 Code of the City of Joplin. Codified Chapters 1 to 57.	24113
May 1, 1961	Adopting the 1959 National Electrical Code.	24456
July 3, 1961	Adopting the 1960 BOCA Building Code.	24491
June 4, 1962	Adopting the 1960 edition of the Fire Prevention Code recommended by the National Board of Insurance Underwriters	24619
December 17, 1962	Adopting the 1962 National Electrical Code.	24707
June 21, 1965	Adopting the 1965 edition of the Fire Prevention Code recommended by the National Board of Insurance Underwriters	25293
October 17, 1966	Adopting the 1965 BOCA Building Code, with amendments.	25573
October 17, 1966	Adopting the 1965 National Electrical Code.	25574
November 2, 1968	Adopting the October 1966 revision of article 16 of the 1965 edition of the Fire Prevention Code.	25765
January 2, 1968	Inspection fees for plumbing	25767
April 7, 1969	An ordinance authorizing the Electrical Board to enter into reciprocity agreements, providing for council approval, setting procedures in granting license or certificates.	25948
January 1, 1970	Adopting the 1968 National Electrical Code.	26069
March 2, 1970	Adopting the 1970 BOCA Building Code with amendments.	26132
July 20, 1970	Adopting the 1968 BOCA Basic Plumbing Code with amendments	26220
May 3, 1971	Adopting the 1970 Edition of the Fire Prevention Code	26373
December 20, 1971	Adopting New Dangerous Building Regulations	26523
January 3, 1972	Adopting the 1971 National Electrical Code.	26533
February 7, 1972	Adopting the 1970 BOCA Basic Plumbing Code with amendments	26568
June 5, 1972	Adopting new section 13.3 (b) of the 1970 Fire Prevention Code	26632
June 19, 1972	Amending and repealing sections of the 1970 BOCA Building Code.	26653

EFFECTIVE DATE	ADOPTED CODE OR LEGISLATION	Ordinance #
July 3, 1972	Adopting the 1970 Supplement to the 1970 BOCA Building Code.	26660
July 3, 1972	Adopting the 1971 Supplement to the 1970 BOCA Basic Plumbing Code	26661
July 3, 1972	Amending ordinance 26533 and adding sections to the 1971 National Electrical Code	26662
July 17, 1972	Amending the 1970 BOCA Building Code by adding sections to provide code coverage for structures used for non-residential purposes.	26666
August 7, 1972	Amending Ordinance 26373 by adding subsection 9, Appendix D, to the 1970 edition of the Fire Prevention Code as applied to the fire lanes at the Northpark Mall	26681
May 7, 1973	Adopting the 1972 Supplement to the 1970 BOCA Basic Building Code.	26877
February 4, 1974	Adopting the 1973 Supplement to the 1970 BOCA Building Code.	27087
September 16, 1974	Amending Ordinance 26681, subsection 9, Appendix D, as applied to the fire lanes at Northpark Mall.	27245
July 21, 1975	Adopting the 1975 National Electrical Code w/ammendments	75-86
May 21, 1980	Adopting the 1978 BOCA Building Code.	80-106
March 2, 1981	Adopting the 1975 BOCA Basic Mechanical Code.	81-29
June 1, 1981	Adopting the 1978 BOCA Basic Plumbing Code.	81-72
April 19, 1982	Adopting the 1970 Edition of the Fire Prevention Code by the American Insurance Association.	82-40
January 3, 1983	Amending Section 14-25 of Joplin City Code by adding alternate Section 16.75e of the Fire Prevention Code.	83-5
July 16, 1984	Adopting the 1984 BOCA Building Code.	84-76
September 4, 1984	Adopting the 1984 BOCA Basic/National Fire Prevention Code	84-104
December 17, 1984	Adopting the 1984 National Electrical Code	84-147
December 17, 1984	Adopting the 1984 BOCA Basic/National Plumbing Code	84-148
December 17, 1984	Adopting the 1984 BOCA Basic/National Mechanical Code	84-149
November 19, 1990	Adopting the 1990 BOCA Building Code	90-179
February 4, 1991	Adopting the 1990 BOCA/National Mechanical Code/1990	91-17
February 4, 1991	Adopting the 1990 BOCA National Plumbing w/ammendments	91-18
February 4, 1991	Adopting the 1990 National Electrical Code.	91-19
February 4, 1991	Adopting the 1990 BOCA Basic/National Fire Prevention Code.	91-20
October 21, 1991	Adopting all precedent subsequent Supplements or Amendments to the 1990 BOCA National Building Code, National Fire Prevention Code, National Basic Mechanical Code, National Plumbing Code.	91-155
January 4, 1993	Amending the 1990 BOCA Building Code Chapter 9, Article 4, Section 9-62, specifically in reference to Snow and Wind loads.	93-6

EFFECTIVE DATE	ADOPTED CODE OR LEGISLATION	Ordinance #
April 19, 1993	Amending Chapter 13 - ELECTRICITY and Chapter 30 - PLUMBING to adopt standardized examination for certification of Electricians and Plumbers and provide for reciprocity of other cities in certain circumstances.	93-46
June 19, 1995	Adopting the 1994 NFPA 101 Life Safety Code.	95-81
May 6, 1996	Amending chapter 14 providing that certain new and commercial construction install key boxes.	96-072
June 2, 1997	Adopting the 1996 National Electrical Code.	97-080
June 2, 1997	Adopting the 1996 BOCA National Fire Prevention Code.	97-081
June 2, 1997	Adopting the 1996 International Mechanical Code/1996.	97-082
June 2, 1997	Adopting the 1995 International Plumbing Code	97-083
June 2, 1997	Adopting the 1996 Edition BOCA National Building Code	97-091
June 19, 2000	Amending section 114-388 "Fire Lanes"	2000-83
March 17, 2003	Adopting the 2000 International Plumbing Code	2003-046
March 17, 2003	Adopting the 2002 National Electrical Code	2003-047
March 17, 2003	Adopting the 2000 International Fire Code	2003-048
March 17, 2003	Adopting the 2000 International Building Code	2003-049
March 17, 2003	Adopting the 2000 International Residential Code	2003-050
March 17, 2003	Adopting the 2000 International Mechanical Code	2003-051
March 17, 2003	Adopting the 2000 NFPA 101 Life Safety Code	2003-052
August 16, 2004	Adopting the 2003 International Fuel Gas Code	2004-188
August 15, 2005	Adopting the 2000 International Property Maintenance Code. (REPEALED)	2005-125
October 9, 2006	Amending article III., of Chapter 26, of the Joplin City code by enacting a new section 26-68, Soil testing for lead prior to Building permit issuance in designated areas.	2006-457
March 17, 2008	Creating of Plan Reviewer Position with job description and salary range.	2008-044
May 5, 2008	Adopting the 2006 International Fire Code and implementing fee changes.	2008-067
May 5, 2008	Adopting the 2006 International Building Code, the 2006 International Mechanical Code, the 2006 International Plumbing Code, the 2006 International Fuel Gas Code, the 2006 International Residential Code, the 2008 National Electrical Code and implementing fee changes.	2008-068

This page intentionally left blank.

Appendix H

ESTIMATED DESIGN WIND PRESSURE AND STRENGTHS OF CONNECTIONS OF JOPLIN WALMART BUILDING #59

H.1 ESTIMATED DESIGN WIND PRESSURE BASED ON IBC 2000

- Basic design wind speed: $V = 90$ mph (3 s gust)
- Exposure category: C
- Building parameters:
 - Low-rise, 290 ft \times 573 ft in plan, with mean roof height $h = 21.33$ ft and 2 ft parapet
 - Gust-effect factor: $G = 0.85$ (rigid building)
 - Partially enclosed¹⁶⁵. Internal pressure coefficient $GC_{pi} = \pm 0.55$
- Importance factor: $I = 1.15$ ¹⁶⁶
- Topographic factor: $K_{zt} = 1.0$ (flat terrain)

The worst-case net design wind pressure for the Walmart building, based on above parameters and design procedure of IBC 2000, is *wind perpendicular to the building's length* (N-S axis). The computed net internal pressure (with $+ GC_{pi}$) and net internal suction (with $- GC_{pi}$) are shown in Table H-1.

Table H-1. Net internal pressure and internal suction for the Walmart building.

Surface	Z (ft)	q (psf)	C _p	qGC _p (psf)	Net Pressure (psf) with	
					+ GC _{pi}	- GC _{pi}
Windward	0 – 15	20.27	0.8	13.78	1.83	25.73
	20	21.47	0.8	14.6	2.65	26.55
	21.3	21.72	0.8	14.77	2.82	26.72
Leeward	All	21.72	-0.5	-9.23	-21.18	2.72
Side wall	All	21.72	-0.7	-12.92	-24.87	-0.97
Roof	0 – 21.3	21.72	-0.9	-16.62	-28.6	-4.67
	21.3 – 42.6	21.72	-0.5	-9.23	-21.2	2.72
	42.6 – 290	21.72	-0.3	-5.54	-17.5	6.4

¹⁶⁵ Assumed based on the conditions where the building envelope was breached during the tornado

¹⁶⁶ Not specified on design drawings obtained by NIST. Assumed based on Occupancy Category III (Buildings and other structures where more than 300 people congregate in one area)

Wind pressure distribution corresponding to the net internal pressure case (+ GC_{pi}), shown below in Fig. H-1, represents the worst load case for wind uplift, with estimated maximum design (code-level) net uplift pressure of 28.6 lb/ft² (psf) on the roof.

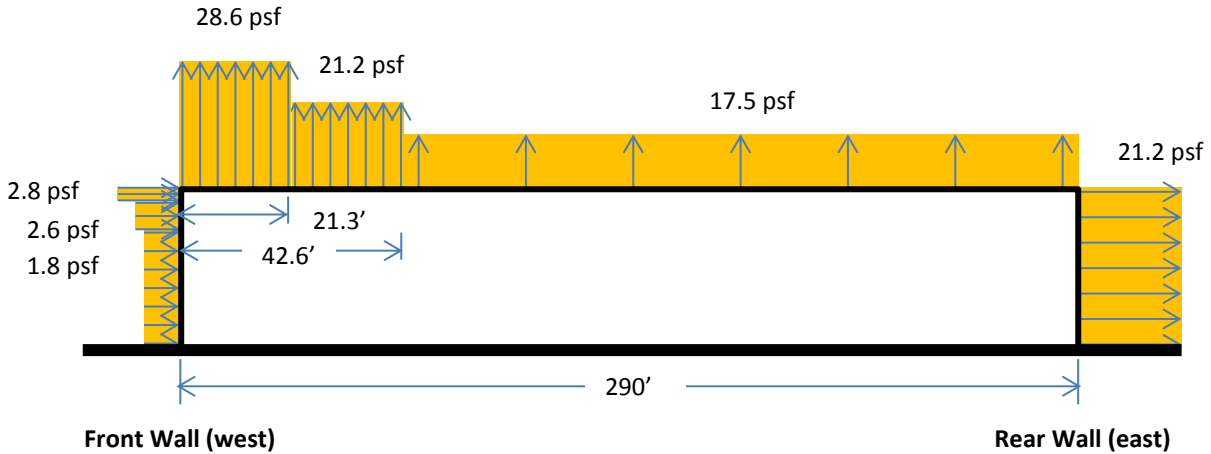

Key: psf, pounds per square foot (lb/ft²).

Figure H-1. Wind pressure distribution for the Walmart building.

H.2 ESTIMATED UPLIFT STRENGTH OF ROOF JOIST-TO-JOIST GIRDER CONNECTIONS

- Roof joist is welded on each end to joist girder by 2 3/16 in. × 1½ in. (weld leg size w × weld length l) fillet welds, E70 electrode
- Design strength per 1/16 in. of fillet weld leg per inch of weld length:

$$= 0.75(0.6F_{EXX})(0.707wl) = 1.392 \text{ kips/in.}$$

- Uplift capacity for 6 in. of total weld length l (3 in. on each end) and 3/16 in. weld leg size:

$$= (1.392 \text{ kips/in.})(3)(6) = 25.05 \text{ kips}$$

- Tributary roof deck area supported by each roof joist: = 39 ft × 5 ft 7½ in. = 219.4 ft²
- Estimated uplift strength of joist-to-girder connections: 25,056 lb/219.4 ft² = 114 lb/ft²

Appendix I

ESTIMATED DESIGN WIND PRESSURE AND STRENGTHS OF CONNECTIONS OF JOPLIN HOME DEPOT BUILDING

I.1 ESTIMATED DESIGN WIND PRESSURE BASED ON BOCA NBC/1996

- Basic design wind speed: $V = 90$ mph (3 s gust)
- Exposure category: C
- Building parameters:
 - Low-rise, one-story, 470 ft \times 250 ft in plan, with 28 ft mean roof height and 4 ft parapet
 - Gust-effect factor: $G = 0.85$ (rigid building)
 - Partially enclosed. Internal pressure coefficient $GC_{pi} = \pm 0.25$
- Importance factor: $I = 1.15$ ¹⁶⁷

Design Wind Pressure for MWFRS:

Basic velocity pressure: $P_V = 0.00256V^2 = 20.7$ lb/ft². Assume Condition I enclosure: $GC_{pi} = \pm 0.25$ (see BOCA NBC/1996). The computed net internal pressure and internal suction based on BOCA NBC/1996 for the MWFRS of Home Depot building is shown below in Table I-1.

The wind pressure distribution corresponding to the net internal pressure case, shown in Fig. I-1, represents the worst load case for wind uplift, with code-level net uplift pressure of 26.2 lb/ft² (psf) on the roof. Note – this calculated value is slightly less than the design uplift pressure of 28.2 psf indicated on the structural drawings of the Home Depot. This confirms that the wind uplift pressure used in designing the Home Depot was in conformance with (and slightly exceeding) the requirement of the building code in effect (BOCA NBC/1996).

Design Wind Pressure for Component and Cladding:

For BTS building, the roof system is an integral part of the MWFRS, not just cladding. Thus the estimated design wind pressure computed above for MWFRS that pertains to the roof could arguably be used for designing the roof. However, treating the roof as component and cladding could yield higher design wind pressure acting on the roof deck panels and the fasteners (puddle welds). The following

¹⁶⁷ Assumed by NIST for this estimation based on Table 1609.5 *Importance Factor (I)* of BOCA NBC/1996. Design drawing obtained by NIST indicated a Wind Load Importance Factor $I = 1.33$ was used. However, this value was inconsistent with value specified by BOCA NBC/1996.

Table I-1. Net internal pressure and internal suction for MWFRS of the Home Depot building.

Surface		Z (ft)	G _h	K _z	C _p	P _v IK _h C _p G _h	P _v IK _h GC _{pi}	Net Pressure (psf) with	
								Internal Pressure	Internal Suction
Windward		0 – 15	1.264	0.8	0.8	19.26	± 5.77	13.5	25.0
		20	1.264	0.87	0.8	20.95	± 5.77	15.2	26.7
		25	1.264	0.93	0.8	22.38	± 5.77	16.6	28.2
		28	1.264	0.97	0.8	23.33	± 5.77	17.6	29.1
		30	1.264	0.98	0.8	23.57	± 5.77	17.8	29.3
		33	1.264	1.01	0.8	24.33	± 5.77	18.6	30.1
Leeward		All	1.264	0.97	-0.5	-14.58	± 5.77	-20.4	-8.8
Side wall		All	1.264	0.97	-0.7	-20.42	± 5.77	-26.2	-14.7
Roof	All	1.264	0.97	-0.7	-20.42	± 5.77	-26.2	-14.7	

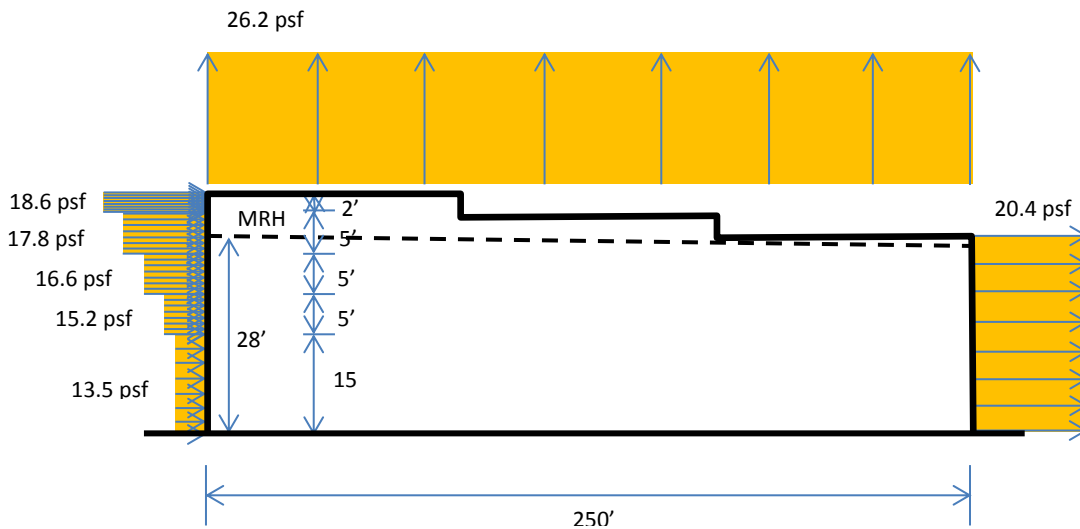

Figure I-1. Wind pressure distribution for MWFRS of the Home Depot building.

calculation estimates the code-level net uplift pressures, based on BOCA NBC/1996, on the roof deck panels and the fasteners if they are considered as component and cladding.

$$P = P_v I K_h [(G C_p) - (G C_{pi})]$$

Where,

$$P_v I K_h = 23.09 \text{ psf (see above and Table I.1),}$$

$GC_{pi} = \pm 0.25$, and

GC_p computed below based on effective wind areas of roof deck panel and tributary area of each fastener (puddle weld):

- Effective wind areas:
 - Roof deck panel: $A = 3 \text{ ft} \times 5.375 \text{ ft} = 16.124 \text{ ft}^2$
 - Fastener (36/4 pattern): $A = 5.8 \text{ ft} \times 1.0 \text{ ft} = 5.8 \text{ ft}^2$
- Roof coefficient (GC_p):

Component	A (sq.ft)	GC_p^{168}	
		Zone 1	Zone 2
Roof deck panel	16.125	-1.38	-2.54
Fastener	5.8	-1.4	-2.6

- Net roof component pressures, psf

Component	Net Uplift Pressure	
	Zone 1	Zone 2
Roof deck panel	-37.6	-64.4
Fastener	-38.1	-65.8

I.2 ROOF BRACING FORCES R_T

Force transferred to roof from lateral pressure on exterior of windward wall:

Equating moments at base of wall (wall extends 2 ft below ground on top of footing):

$$\begin{aligned}
 30R_T &= (13.5)(15) \left(\frac{15}{2} + 2 \right) + (15.2)(5) \left(\frac{5}{2} + 7 \right) = \\
 &+ (16.6)(5) \left(\frac{5}{2} + 2 \right) + (17.8)(5) \left(\frac{5}{2} + 7 \right) = \\
 &+ (18.6)(2) \left(\frac{2}{2} + 3 \right) = \\
 \Rightarrow R_T &= 307.1 \text{ plf along roof}
 \end{aligned}$$

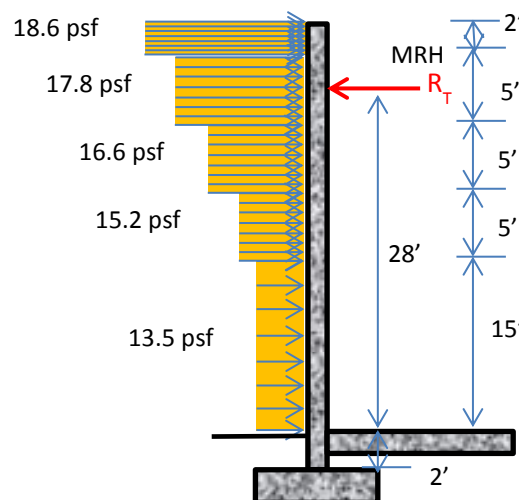

¹⁶⁸ Zone 3 is treated as Zone 2 due to the 4-foot height parapet (greater than 3 ft)

Force transferred to roof from uniform pressure on leeward wall:

$$30R_T = (-14.6)(32)\left(\frac{32}{2} + 2\right) =$$

$$\Rightarrow R_T = -279.9 \text{ plf along roof}$$

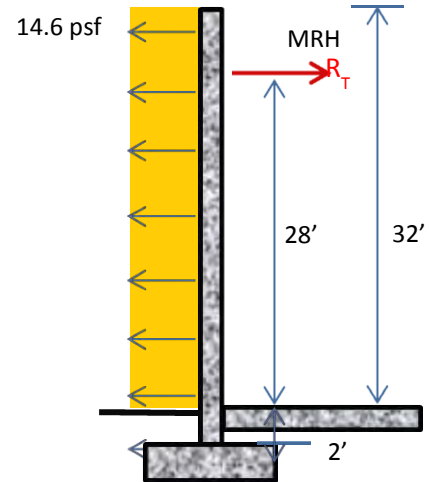

Force transferred to roof from uniform internal pressures on leeward wall:

$$30R_T = (\pm 5.77)(28)\left(\frac{28}{2} + 2\right) =$$

$$\Rightarrow R_T = \pm 86.2 \text{ plf along roof}$$

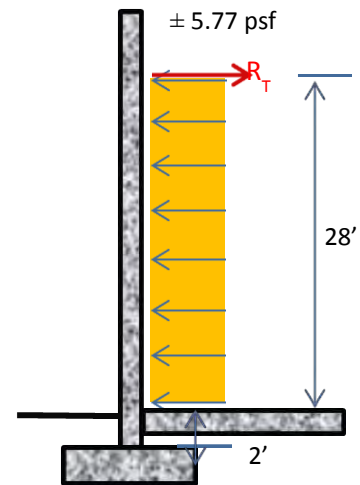

Net force R_T per foot transferred to roof due to lateral wind load:

With internal suction:

$$\text{Windward: } R_T = 307.1 + 86.2 = 393.3 \text{ plf}$$

$$\text{Leeward: } R_T = -279.9 + 86.2 = -193.8 \text{ plf}$$

$$\Rightarrow \text{Net design roof bracing force due to lateral wind loads: } W = 393.3 + 193.8 = 587.1 \text{ plf}$$

I.3 ROOF DIAPHRAGM SHEAR AND STIFFNESS

Diaphragm Shear:

Design diaphragm shear force:

$$R = (L/2)(W) = 470 \times \frac{1}{2} \times 587.1 = 137,968.5 \text{ lb}$$

Required nominal unit shear at side walls (design diaphragm shear):

$$S = R/B = 137,968.5/250 = 552 \text{ plf}$$

Note: This calculated roof diaphragm shear value of 552 *plf* confirms the design diaphragm shear value of 560 *plf* shown on the Home Depot design drawings.

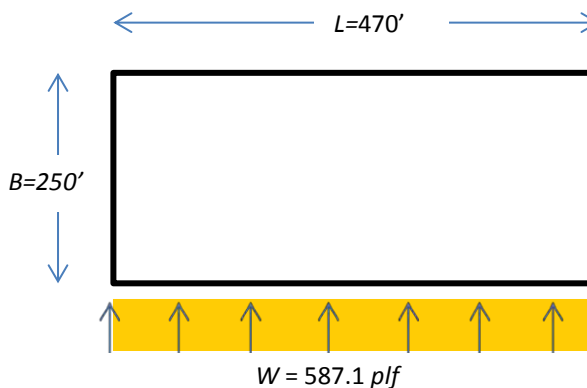

Diaphragm Shear Stiffness G' :

Roof diaphragm shear stiffness G' is a function of roof deck type and size, support joist spacing, and fastener types and pattern. For the Home Depot:

- Roof deck: B, 1.5 in. \times 22-gauge wide-rib, 36 in. width, three-span continuous
- Joist spacing L_V : Varied from 5.4 ft to 5.8 ft (**Note:** This conforms to FM Global's recommended span of ≤ 6 ft for 22-gauge roof deck)
- Fasteners:
 - At support: 5/8 in.- ϕ puddle welds, 36/4 pattern
 - Side laps: #10 Buildex screws, 7 per span

G' , based on SDI Deck Diaphragm Design Manual (2nd Edition) and CMC Joist and Deck Tables, for 5/8 in.- ϕ puddle weld with 36/4 weld pattern and #10 Buildex screws side laps connection:

$$G = \frac{K_2}{3.78 + \frac{0.3D_{xx}}{L_V} + 3K_1 L_V}$$

Where:

$$K_2 = 29,500t = 29,500(0.0295) = 870 \quad (t : \text{deck thickness} = 0.0295 \text{ in. for 22-gauge deck})$$

$$D_{xx} = \text{Deck warping factor, dependent on fastener pattern at supports} = 1072 \quad (\text{for 36/4 pattern})$$

$$K_1 = 0.181 \quad (\text{factor relates to slip coefficient})$$

$$G = \frac{870}{3.78 \times \frac{0.3 \times 1072}{5.8} + 3 \times 0.181 \times 5.8} = 13.9 \text{ k/in.}$$

Note: $6.7 \text{ k/in.} < G = 13.9 \text{ k/in.} < 15 \text{ k/in.} \Rightarrow$ the Home Depot roof is a flexible roof diaphragm based on ACI 551 roof shear stiffness classifications.

Roof diaphragm maximum shear deflection due to code-level shear force:

$$\Delta_{CL} = \frac{WL^2}{8G} = \frac{(587.1)(470)^2}{8(13.9)10^3(250)} = 4.7 \text{ in.}$$

I.4 UPLIFT AND SHEAR CAPACITIES OF ROOF DECK-TO-JOIST CONNECTIONS

Strength based on uplift alone:

ASD governing load combination for net uplift force acting on deck-to-joist connection:

$$0.6D + W$$

Where:

$D = 16 \text{ psf}$ (service dead load shown on the Home Depot design drawings)

$W = -26.2 \text{ psf}$ (service wind uplift load computed above based on BOCA NBC/1996)

Required uplift resistance (or required tensile strength) of puddle welds, T , at service load:

$$T = L_v(0.6D + W)(1.1) = (5.8)[(0.6)(16) - 26.2](1.1) = -105.9 \text{ plf}$$

Nominal uplift resistance per foot along roof of puddle welds, T_n , based on 3/4 weld pattern, 5/8 in.- ϕ puddle weld, and 5.8 ft span length:

$$T_n = U \times L_v = \frac{K P}{C L_v} \times L_v = \frac{K P}{C}$$

Where:

$K = 2.7$ (for 3/4 weld pattern, based on SDI Deck Diaphragm Design Manual, 2nd Edition)

$C = 3 \text{ ft}$ (width of roof deck)

$P = 0.28t(d-t)F_u$ (Nominal uplift resistance per puddle weld, per AWS D1.3/D1.3M-2008-Structural Welding Code – Sheet Steel)

$t = 0.0295 \text{ in.}$ (thickness of 22-gauge metal roof deck)

$d = 5/8 \text{ in.}$ (weld diameter)

$F_u = 55 \text{ ksi}$

$$\Rightarrow P = 0.28 \times 0.0295 \times \left(\frac{5}{8} L - 0.0295 \right) \times 55 = 0.273 \frac{\text{kip}}{\text{weld}} = 273 \text{ lbs per weld},$$

Thus,

$$T_n = \frac{3.7 \times 273}{3.0} = 336.7 \text{ plf}$$

Safety factor for uplift strength of puddle weld:

$$u = \frac{T_n}{T} = \frac{336.7}{105.9} = 3.2 = 2.5 \text{ required} \Rightarrow \text{OK for uplift alone}$$

Nominal uplift capacity of roof-deck-to-joist connection:

$$U_{nL} = \frac{T_n}{L_v} = \frac{336.7 \text{ plf}}{5.375 \text{ ft}} = 62.6 \text{ psf}$$

Note:

- The 62.6 psf uplift capacity of the roof-deck-to-joist connection exceeds the design uplift pressure of 26.2 psf by a safety factor of 2.4. This means a code-level uplift pressure would not have caused the failure of the roof-deck-to-joist connections (or the disconnection of the metal roof deck panels).
- Assuming the spatial relationship between lateral wind speed and uplift pressure in tornadoes is similar to that used in ASCE 7 standards, the 62.6 psf uplift capacity is equivalent to a lateral wind speed $V =$

Strength based on combined uplift and shear:

ASD shear and tension interaction equation for support fasteners (puddle welds):

$$\left(\frac{Q_{f \text{ usable}}}{Q_{f \text{ no uplift}}} \right)^{1.5} + \left(\frac{uT}{T_n} \right)^{1.5} = 1.0$$

Where:

$$u = 2.5 \text{ (safety factor for weld in tension)}$$

$$T = 105.9 \text{ plf (above)}$$

$$T_n = 1,800.7 \text{ plf (above)}$$

$$Q_{f \text{ no uplift}} = 2,010 \text{ lb (nominal shear strength per } 5/8 \text{ in. } \phi \text{ puddle weld (tabulated in SDI manual and CDC Tables))}$$

$Q_{f \text{ usable}}$: Available nominal shear strength of puddle weld in the presence of an uplift force:

$$Q_{f \text{ usable}} = \left(1.0 - \left(\frac{uT}{T_n} \right)^{1.5} \right)^{0.67} \times Q_{f \text{ no uplift}} = \left(1.0 - \left(\frac{2.5 \times 105.9}{1800.7} \right)^{1.5} \right)^{0.67} \times 2010 = 1933.4 \text{ lbs}$$

Required nominal unit shear at side walls:

$$S_{n \text{ required}} = 552 \text{ plf (from roof bracing forces calculation above)}$$

Nominal shear strength S_n of type B 1.5 in. \times 36 in. wide-rib roof deck with 36/5 puddle weld pattern based on the SDI Deck Diaphragm Manual and CMC Joist and Deck Tables:

$$\text{For 5.5 ft deck span} \Rightarrow S_n = 1,318 \text{ plf}$$

$$\text{For 6.0 ft deck span} \Rightarrow S_n = 1,230 \text{ plf}$$

$$\text{Thus for } L_V = 5.8 \text{ ft deck span} \Rightarrow S_n = 1318 - (1318 - 1230)(0.3/0.5) = 1265.2 \text{ plf}$$

Available nominal deck shear strength adjusted for presence of uplift (accounting for effect of shear and tension interaction):

$$S_{n \text{ available}} = S_n \left(\frac{Q_{f \text{ available}}}{Q_{f \text{ no uplift}}} \right) = 1265.2 \left(\frac{1933.4}{2010} \right) = 1,217 \text{ plf}$$

Factor of safety in combined shear and tension of deck-to-joist connection:

$$\frac{S_{n \text{ available}}}{S_{n \text{ required}}} = \frac{1217}{552} = 2.2 = 2.5$$

Roof-deck-to-joist connection would not have failed under combined shear (lateral wind load) and tension (wind uplift) forces at code-level wind load. However, the safety factor is slightly less than is typically required for this design.

Appendix J

ESTIMATED DESIGN WIND PRESSURE FOR JOPLIN EAST MIDDLE SCHOOL GYMNASIUM

J.1 DESIGN WIND PRESSURE BASED ON IBC 2000

- Basic design wind speed: $V = 90$ mph (3 s gust)
- Exposure category: C
- Building parameters:
 - Low-rise, with mean roof height $h = 39.8$ ft
 - Arched roof, rise-to-span ratio $r = 9\text{ ft}/102\text{ ft} = 0.9$; $K_d = 0.85$
 - 102 ft \times 142.2 ft plan dimensions
 - Gust-effect factor: $G = 0.85$ (rigid building)
 - Enclosed. Internal pressure coefficient $GC_{pi} = \pm 0.18$
- Importance factor: $I = 1.0$

Net design wind pressure that corresponds to the wind parallel to ridge load case represents the worst design load case for wind uplift, with maximum design wind uplift pressure of 17.3 lb/ft² (psf) acting on the roof system. Table J-1 and Fig. J-1 and J-2 summarize the wind pressure acting on the main wind-force resisting system (MWFRS) of Joplin East Middle School’s gymnasium building based on the wind parallel to ridge load case.

Table J-1. Wind pressure acting on the MWFRS of the Joplin East Middle School gymnasium.

Surface	Z (ft)	q (psf)	G	C _p	qGC _p (psf)	Net Pressure (psf) with	
						+ GC _{pi}	- GC _{pi}
Windward	0 – 15	15.0	0.85	0.8	10.2	6.9	13.5
	20	15.8	0.85	0.8	10.7	7.4	14.0
	25	16.5	0.85	0.8	11.2	7.9	14.5
	30	17.2	0.85	0.8	11.7	8.4	15.0
	35.3	17.8	0.85	0.8	12.1	8.8	15.4
	39.8	18.3	0.85	0.8	12.4	9.1	15.7
	44.3	18.7	0.85	0.8	12.7	9.4	16.0
Leeward	All	18.3	0.85	-0.42	-6.5	-9.8	-2.9

Surface	Z (ft)	q (psf)	G	C _p	qGC _p (psf)	Net Pressure (psf) with	
						+ GC _{pi}	- GC _{pi}
Side wall	All	18.3	0.85	-0.7	-10.9	-14.2	-7.3
Roof	0 to h	18.3	0.85	-0.9	-14.0	-17.3	-10.4
	h to 2h	18.3	0.85	-0.5	-7.8	-11.1	-4.2
	2h	18.3	0.85	-0.3	-4.7	-8.0	-1.1

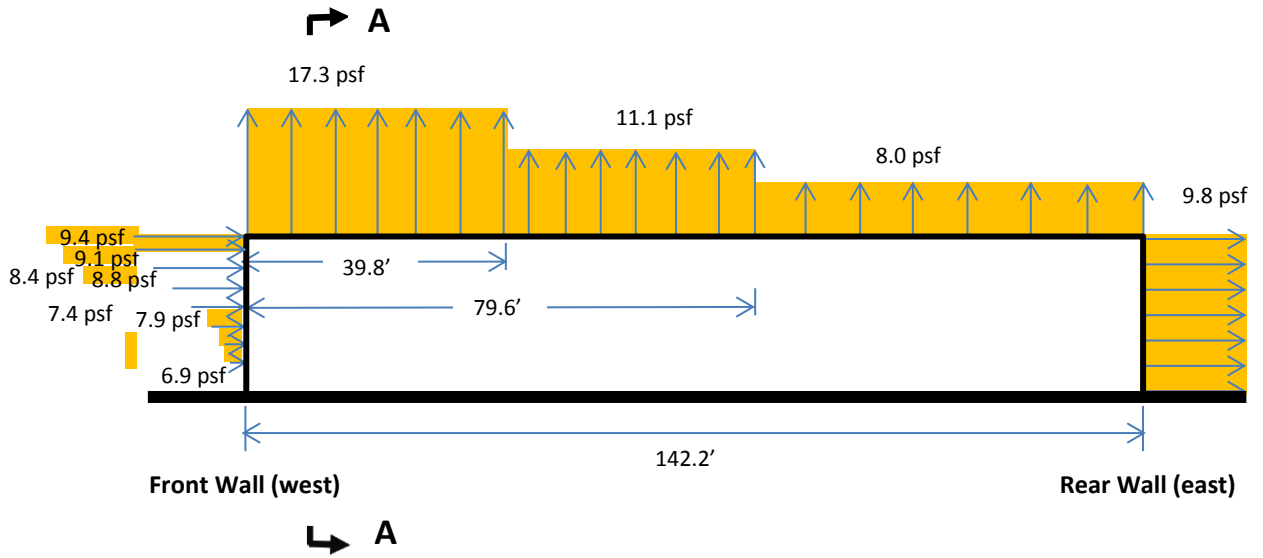
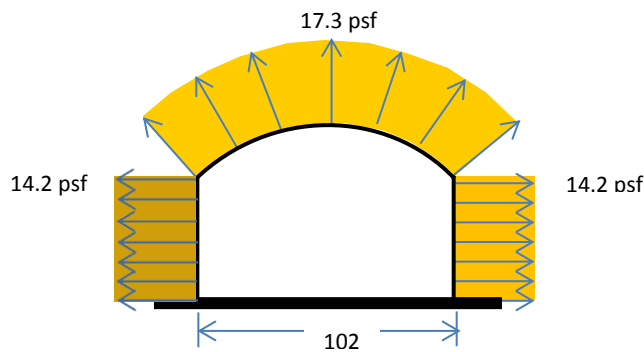

Figure J-1. Wind pressure distribution along length of the Joplin East Middle School Gymnasium.



Section A-A

Figure J- 2. Wind pressure distribution on the cross section of the Joplin East Middle School Gymnasium.

Appendix K

QUALITATIVE ANALYSIS OF THE CURRENT STATE OF TORNADO WARNING SYSTEMS IN THE U.S.

Throughout the United States, many cities have siren-based communication systems to alert residents and visitors about emergencies that require immediate action (also known as rapid-onset events). The most common use of the sirens is to alert people of severe weather or tornadoes in the vicinity; however, they can be used to alert or warn citizens of many different types of disasters, including severe weather, chemical emergencies, HAZMAT spills, national security attacks, floods, fires, or other types of emergencies.

An assessment of more than 75 U.S. counties, cities, and towns was conducted to identify the similarities and differences among siren systems from community to community. An Internet search was conducted to identify at least one community from each tornado-prone State that used a siren system to alert of emergencies. Table K- 1 shows the number of counties, cities, or towns reviewed from each State; and although some communities from east and west coast States were assessed, the focus of this assessment was on States located in the tornado-prone region of the Midwestern United States commonly referred to as “tornado alley.” There was no systematic method for choosing communities; instead, communities were chosen for this assessment if they provided emergency communications procedures on a website that was accessible to the public.

Table K- 1. The number of qualifying community emergency management websites chosen, by State.

State	No. of Sources
Alabama	3
Alaska	/
Arizona	/
Arkansas	2
California	1
Colorado	3
Connecticut	/
Delaware	/
Florida	2
Georgia	4
Hawaii	1
Idaho	1
Illinois	4

State	No. of Sources
Montana	/
Nebraska	1
Nevada	/
New Hampshire	/
New Jersey	/
New Mexico	1
New York	/
North Carolina	/
North Dakota	/
Ohio	4
Oklahoma	5
Oregon	1
Pennsylvania	/

State	No. of Sources
Indiana	3
Iowa	4
Kansas	3
Kentucky	3 (5)
Louisiana	
Maine	
Maryland	
Massachusetts	
Michigan	2
Minnesota	2
Mississippi	4
Missouri	4

State	No. of Sources
Rhode Island	
South Carolina	
South Dakota	
Tennessee	3
Texas	4
Utah	1
Vermont	
Virginia	
Washington	1
West Virginia	
Wisconsin	4
Wyoming	3

The assessment showed that emergency information about tornadoes is disseminated via siren systems using a variety of methods before the tornado hits. The main differences found among these 76 communities pertained to siren usage (i.e., the types of emergencies that the sirens were used for), activation procedures, sounding patterns, and the guidance provided to the public on how to respond to siren soundings.

While some communities were found to use their sirens only for tornado emergencies, most of the sampled communities (59 out of 76) use their sirens for multiple types of events. Which types of emergencies the sirens are used for seems to be a decision made by each local community. Even jurisdictions that are adjacent to each other can use sirens for different types of emergencies. For example, Rankin County, Mississippi, sounds its sirens only for tornadoes, while adjacent Hinds County, Mississippi, sounds sirens for severe weather, national security events, and life-threatening situations that may impact the public (which are defined by the officials in charge of turning on the sirens). Problems with situational awareness may arise for residents who travel frequently between jurisdictions that use sirens differently.

There are differences in siren activation procedures among communities as well. In the majority of communities sampled, sirens are activated if the National Weather Service (NWS) issues a warning for the area served by the sirens. Other communities have decided to rely mainly on local officials, trained tornado spotters, and/or a local emergency team for determinations about whether (and when) to activate the sirens. In some places, the fire or police department is in charge of sounding the sirens.

The patterns of sounds used by siren systems also differ from community to community. While the majority of the 76 sampled locations did not provide publicly accessible online information about the lengths (in minutes) of their siren soundings, some did, and differences were found to exist even among this smaller sample. Some communities may sound the siren for a finite time interval, whereas others

may sound the siren continuously using a repeating time interval. Using a finite time interval, a siren may sound for 3 min and then stop, regardless of when the emergency begins and ends. On the other hand, when using a repeating time interval, a siren may sound for 3 min and turn off for 8 min, and repeat that pattern until the emergency is over. There is the potential for individuals familiar with a repeating time interval to become confused when visiting another community that uses a finite time interval pattern (and vice versa).

There are also differing practices in regard to the types of sounds used. In some cases, the sound pattern differs based upon whether there is an actual emergency or the community is simply testing the system. In others, the community disseminates different sounds or tones to distinguish between types of emergencies; e.g., the tones are different for system tests versus hazmat warnings versus weather warnings. Plymouth, Minnesota, for example, uses a steady siren for tornadoes and a warble (or wavering) siren for all other emergencies. Finally, sirens may be set at differing volume levels, based upon spacing and the landscape, from community to community.

Guidance provided to the public on how they should react when sirens are sounded varies across communities as well. In 10 of the 76 communities sampled, when a siren is sounded, individuals are supposed to turn to an information source, like a weather radio or news channel, to find more information. In 35 of the sampled communities, individuals are supposed to take cover and then tune into an emergency information source, like a weather radio or a local radio or television news station. However, only 18 of these 35 communities provide further guidance on what “taking cover” actually means. Generally, recommendations for “taking cover” state that if an individual is in a sturdy building, they should immediately shelter in a basement, storm cellar, or a small interior room on the lowest level of the structure. The same recommendation is given for sheltering in schools, factories, or shopping centers. Also, it is generally recommended to stay away from glass. Five communities recommended that individuals should cover their head with a blanket or get under a table or mattress when sheltering in an interior room. Thirteen of the sampled communities give even more guidance on where to shelter; they instruct their residents to evacuate mobile homes and vehicles upon hearing the sirens sounded for a tornado and to go into a sturdy building. If there is no sturdy building available, people are instructed to lay flat in a ditch and cover their heads but beware of flash floods.

Emergency communication issues can arise even within the same community. A city in Kentucky has both a siren and a public address system. Their intent is to use the siren to alert the public, and then to follow the alert with instructions on what to do via the public address system. This system provides a good example of how to structure alerts and warnings to prompt effective responses from the community before and during disasters. However, the problem is that the sirens can be heard throughout a half-mile radius, while the public address system can only be heard within a quarter-mile radius. This can cause confusion in the quarter-mile areas where people can hear a siren but not the public address system (www.lexingtonky.gov/index.aspx?page=1420).

Of the 76 communities sampled, all of which had outdoor sirens, 42 stated specifically that the purpose of these sirens is to alert only persons located outdoors. None of the communities stated that their purpose is to alert people located indoors as well as outdoors. In Houston, Georgia, the sirens are placed only in areas where citizens are unlikely to hear any other warning, rather than all throughout the city. In Madison County, Alabama, the sirens can be heard by about 75 percent of the population, while in Louisville, Kentucky, 94 percent of the population can be reached with the sirens. Little Rock, Arkansas,

states that its sirens are not intended to alert people who are indoors, whether or not they are sleeping, or who are in vehicles with the windows rolled up.

Overall, outdoor warning systems vary among communities within the United States, both within and outside of tornado-prone areas. Many communities, especially smaller towns and rural areas, even within tornado alley, do not have sirens. Additionally, there is significant variability in the design of tornado communication systems that can make it difficult to understand, from city to city and even within the same area, the information that they convey and how to appropriately respond.

Appendix L

U.S. CODES AND STANDARDS ON OUTDOOR WARNING SYSTEMS

There are national model codes and standards applicable to outdoor siren-based communication systems for tornadoes (and other emergencies). A model code is a set of rules that is recommended for others to follow. A model code does not carry the force of law unless it is adopted. On the other hand, a standard is a technical document that contains more detailed description of how to measure, test, or satisfy the provisions of a particular code. As an example, a code may say that a community or a building must have an alarm system. The standard will provide more detailed information on how to meet the requirements of this code, including information about what kind of system must be installed and how the system must work (www.nfpa.org).

One national model code, NFPA 72, or the National Fire Protection Association's (NFPA) *National Fire Alarm and Signaling Code*¹⁶⁹, is specifically devoted to emergency communication systems, and can be applied to tornado siren systems. NFPA 72 contains a chapter (Chapter 24) specifically devoted to emergency communication systems (2013). This chapter establishes minimum requirements for the performance, reliability, and quality of installation for emergency communication systems. By definition, emergency communication systems are those that are intended to communicate information about emergencies, including (but not limited to) fires, accidents, and natural disasters. Chapter 24 provides requirements for in-building communication systems, namely one-way and two-way in-building fire emergency voice/alarm communication systems, in-building mass notification systems, two-way radio communications enhancement systems (in buildings), area of refuge emergency communication systems (in buildings), and elevator emergency communication systems (in buildings). For the category that is most applicable to a community-wide tornado siren system, namely wide-area mass notification systems, NFPA 72 specifies requirements for the wide-area systems' components, including the central control station, high-power speaker arrays, high-power speaker array enclosures and mounting, and speaker array structural loads for wind- and seismic-resistant design. Additionally, this code specifically states that these systems should not be used to provide mass notification inside any structures. In other words, these systems are to be designed and used only for outdoor alert or warning dissemination.

Whereas previous guidance was provided in the annex, the most recent revision of NFPA 72 (2013) begins to provide guidance on how to create and disseminate an emergency message, if the alert or warning system has that capacity. This revision suggests ways to improve intelligibility, the use of an alert tone in addition to a message, and the types of message content that will prompt a more efficient recipient response. This guidance is helpful for those communities with outdoor public address systems or visual signage; however, there is no mention in this model code about requirements for sound patterns, length of sounds, sound types, etc., or about the use of the siren system itself.

¹⁶⁹ Even though NFPA 72 has been a code for a number of years, it is a referenced standard in the model fire codes and is often administered and enforced in that manner.

All other current requirements that can be applied to tornado siren systems are standards. The first group of standards, listed below, focus on providing requirements for the construction, performance, and testing of the entire communication system.

- NFPA 1221 (2010), *Standard for the Installation, Maintenance, and Use of Emergency Services Communication Systems* (Chapter 14 on Public Alerting Systems)
- UL¹⁷⁰ 2017 (2011), *Standard for General-Purpose Signaling Devices and Systems*
- UL 1971 (2008), *Standard for Signaling Devices for the Hearing Impaired*
- IEC¹⁷¹ 60849 (1998), *Standard for Sound Systems for Emergency Purposes*

NFPA 1221, or the NFPA's *Standard for the Installation, Maintenance, and Use of Emergency Services Communication Systems* has a chapter (Chapter 14) that focuses on public alerting systems. The standard states that such systems can be used to alert the public to natural or man-made events, including tornadoes. However, this standard provides very little in the way of requirements and even cites NFPA 72 for requirements on the audible alarm.

UL also has a standard on signaling devices intended for emergency or non-emergency use in both indoor or outdoor locations (UL 2017–2011), that can be applicable to tornado warning systems. The standard provides requirements for device construction and performance, as well as tests for evaluating the performance of particular components or capabilities. UL also has a standard on signaling devices for the hearing impaired (UL 1971–2008) that can be applicable to tornado warning systems. This standard covers the construction of the device's enclosure, cover, ventilation openings, corrosion protection, insulating materials, mounting parts, operating mechanisms, and wiring, cables, connections, and circuit boards (i.e., mainly the construction of the device). The standard also provides requirements for the performance of the system by specifying a series of tests. Installation and operating instructions are included as well.

Finally, IEC 60849 (1998) is another standard on sound systems for emergency purposes. The standard applies to sound reinforcement and distribution systems that are used to effect rapid mobilization of occupants in an indoor or outdoor area in an emergency. It specifies performance requirements for sound systems that use tone signals or voice announcements to broadcast information for the protection of lives.

All four of these standards focus on requirements for designing and installing the notification system, without providing much in the way of requirements for system use (other than intelligibility measurements, which will be described below). These standards do not address how the device should be used to disseminate information, such as the types of emergencies for which the system should be used, system activation procedures, sounding patterns, or guidance that should be provided to the community about the system.

Another group of standards, listed below, focus primarily on sound and intelligibility levels (including how to measure each):

¹⁷⁰ Underwriters Laboratories.

¹⁷¹ International Electrotechnical Commission.

- ANSI¹⁷² S1.13 (2010), *Measurement of Sound Pressure Levels in Air*
- ANSI S1.26 (2009), *Method for the Calculation of Absorption of Sound by the Atmosphere*
- ANSI S12.14 (2007), *Methods for the Field Measurement of the Sound Output for Audible Public Warning Devices Installed at Fixed Locations Outdoors*
- ANSI S3.2 (2009), *Method for Measuring the Intelligibility of Speech over Communications Systems*
- ISO¹⁷³ 9921 (2003), *Ergonomic Assessment of Speech Communication*
- ANSI S3.5 (1997), *Methods for the Calculation of the Speech Intelligibility Index (SII)*
- IEC 60268–16 (2011), *Sound System Equipment (Part 16: Objective Rating of Speech Intelligibility by Speech Transmission Index*

First, ANSI S1.13 (2010), *Measurement of Sound Pressure Levels in Air*, provides an objective way to measure sound pressure, or pressure fluctuations, in the air. The greater the amplitude of pressure fluctuation, the “louder” the sound will be perceived. This standard presents a method that relies solely on physical parameters and not on subjective interpretation or opinion about volume. This relates specifically to emergency communication for tornadoes because it provides a standardized method of evaluating the performance of emergency sirens (i.e., whether the sound will reach specified areas of the community).

Similarly, ANSI S1.26 (2009), *Method for Calculation of the Absorption of Sound by the Atmosphere*, provides a method of calculating atmospheric absorption losses of sound from any moving or stationary source for a range of meteorological conditions. This becomes especially useful when evaluating whether siren tones will reach desired areas under the types of weather conditions expected during tornadoes.

The standard most relevant to tornado sirens is ANSI S12.14 (2007), *Methods for the Field Measurement of the Sound Output for Audible Public Warning Devices Installed at Fixed Locations Outdoors*. This standard provides procedures for measuring and reporting certain properties of sounds produced by audible public warning devices. ANSI S12.14 can be used, for example, by customers of public warning devices to verify the compliance of their systems with specific sound output specifications.

The last four standards listed above all relate to measuring or assessing speech intelligibility, i.e., the capability of being understood, comprehensible, and clear (NFPA 2010). Intelligibility measurements apply to mass communication or siren systems that allow for the dissemination of voice messages. ANSI S3.2 (2009), *Method for Measuring the Intelligibility of Speech over Communication Systems*, presents a standardized method for evaluating the intelligibility of a voice communication system. This method involves comparing the monosyllabic words trained listeners receive (and identify) with the words trained talkers or speech coders speak into a communication system. The communication system connects the talkers with the listeners, all of whom are required to be native speakers of English and have no speech or hearing defects. ISO 9921 (2003), *Ergonomic Assessment of Speech Communication*, standardizes

¹⁷² American National Standards Institute.

¹⁷³ International Organization for Standardization.

ergonomic assessment of speech communication by recommending levels of speech–communication quality required for conveying messages in different applications, including when warning of a hazard or danger. Referenced within ISO 9921 are terms known as the “speech intelligibility index” and “speech transmission index.” Both refer to objective measures for predicting the intelligibility of speech. ANSI recently updated its standard on one method, which is now entitled ANSI S3.5 (1997), *Methods for the Calculation of the Speech Intelligibility Index (SII)*, and the IEC also updated their standard on a different method, which is referred to as IEC 60268, Part 16, “Objective Rating of Speech Intelligibility by Speech Transmission Index.”

There are also standards that are devoted to the individual physical components that make up communication systems. Two examples follow:

- UL 1480 (2010), *Standard for Speakers for Fire Alarm, Emergency, and Commercial and Professional Use*
- UL 1989 (2010), *Standard for Standby Batteries*

The one most specific to emergency communication is UL 1480 (2010), *Standard for Speakers for Fire Alarm, Emergency, and Commercial and Professional Use*. This standard lists requirements for the construction of these types of speakers as well as various types of speaker performance tests. Similar standards are available for other components of communication systems, such as the UL 1989 (2010) standard on standby batteries.

In sum, no national codes or standards exist to provide requirements or standardization on the ways in which outdoor tornado siren systems should be used to disseminate emergency communications before or during tornadoes. Instead, as indicated above, current codes and standards focus on the construction, performance, and testing of the physical components of such systems. NFPA 72 has begun to provide guidance on the types of messages that should be disseminated via wide–area voice communication systems (typically used in communities); however, this guidance does not assist those communities that must rely on tone–based sirens (i.e., systems without the ability to send public address announcements).

Appendix M

NOAA/NWS Warning Text for the Joplin Tornado

M.1 WARNING ISSUED AT 5:09 PM CDT

WFUS53 KSGF 222209

TORSGF

MOC097-222300-

/O.NEW.KSGF.TO.W.0030.110522T2209Z-110522T2300Z/

BULLETIN – EAS ACTIVATION REQUESTED

TORNADO WARNING

NATIONAL WEATHER SERVICE SPRINGFIELD MO

509 PM CDT SUN MAY 22 2011

THE NATIONAL WEATHER SERVICE IN SPRINGFIELD HAS ISSUED A

* TORNADO WARNING FOR...

WESTERN JASPER COUNTY IN SOUTHWEST MISSOURI...

* UNTIL 600 PM CDT.

* AT 505 PM CDT...NATIONAL WEATHER SERVICE DOPPLER RADAR INDICATED A TORNADO 10 MILES WEST OF CARL JUNCTION...OR 6 MILES EAST OF COLUMBUS...MOVING EAST AT 30 MPH. THIS STORM HAS A HISTORY OF PRODUCING FUNNEL CLOUDS AND TENNIS BALL SIZE HAIL.

* LOCATIONS IMPACTED INCLUDE AIRPORT DRIVE...ALBA...ASBURY...ATLAS...BROOKLYN HEIGHTS...CARL JUNCTION...CARTERVILLE...LAKESIDE...NECK CITY...NORTHEASTERN JOPLIN...OAKLAND PARK...ORONOGO...PURCELL...WACO AND WEBB CITY.

INTERSTATE 44 BETWEEN MILE MARKERS 13 AND 18 WILL ALSO BE IMPACTED BY THIS TORNADO.

IN ADDITION TO A TORNADO...THIS STORM IS CAPABLE OF PRODUCING LARGE DAMAGING HAIL UP TO TENNIS BALL SIZE.

PRECAUTIONARY/PREPAREDNESS ACTIONS...

THE SAFEST PLACE TO BE DURING A TORNADO IS IN A BASEMENT. GET UNDER A WORKBENCH OR OTHER PIECE OF STURDY FURNITURE. IF NO BASEMENT IS AVAILABLE...SEEK SHELTER ON THE LOWEST FLOOR OF THE BUILDING IN AN INTERIOR HALLWAY OR ROOM SUCH AS A CLOSET. USE BLANKETS OR PILLOWS TO COVER YOUR BODY AND ALWAYS STAY AWAY FROM WINDOWS.

IF IN MOBILE HOMES OR VEHICLES...EVACUATE THEM AND GET INSIDE A SUBSTANTIAL SHELTER. IF NO SHELTER IS AVAILABLE...LIE FLAT IN THE NEAREST DITCH OR OTHER LOW SPOT AND COVER YOUR HEAD WITH YOUR HANDS.

&&

LAT...LON 3733 9461 3735 9436 3708 9430 3711 9462 3720 9462

TIME...MOT...LOC 2208Z 260DEG 26KT 3716 9472

HAIL 2.50IN

\$\$

WISE

M.2 WARNING ISSUED AT 5:17 PM CDT

WFUS53 KSGF 222217

TORS GF

KSC021-MOC097-145-222300-

/O.NEW.KSGF.TO.W.0031.110522T2217Z-110522T2300Z/

BULLETIN – EAS ACTIVATION REQUESTED

TORNADO WARNING

NATIONAL WEATHER SERVICE SPRINGFIELD MO

517 PM CDT SUN MAY 22 2011

THE NATIONAL WEATHER SERVICE IN SPRINGFIELD HAS ISSUED A

* TORNADO WARNING FOR...

NORTHWESTERN NEWTON COUNTY IN SOUTHWEST MISSOURI...

SOUTHEASTERN CHEROKEE COUNTY IN SOUTHEAST KANSAS...

SOUTHWESTERN JASPER COUNTY IN SOUTHWEST MISSOURI...

* UNTIL 600 PM CDT.

* AT 514 PM CDT...NATIONAL WEATHER SERVICE DOPPLER RADAR INDICATED A TORNADO NEAR RIVERTON...OR 4 MILES NORTH OF BAXTER SPRINGS...MOVING NORTHEAST AT 40 MPH.

* LOCATIONS IMPACTED INCLUDE BAXTER SPRINGS...CLIFF VILLAGE...DENNIS ACRES...DIAMOND...DUENWEG...DUQUESNE...FIDELITY...GALENA...IRON GATES...JOPLIN...LEAWOOD...LOWELL...REDINGS MILL...RIVERTON...SAGINAW...SHOAL CREEK DRIVE...SHOAL CREEK ESTATES...SHOAL CREEK ESTATE AND SILVER CREEK.

INTERSTATE 44 BETWEEN MILE MARKERS 0 AND 13 WILL ALSO BE IMPACTED BY THIS TORNADO.

IN ADDITION TO A TORNADO...THIS STORM IS CAPABLE OF PRODUCING LARGE DAMAGING HAIL UP TO GOLF BALL SIZE.

THERE IS ADDITIONAL TORNADO WARNING FOR A SEPARATE STORM ACROSS CENTRAL AND NORTHERN JASPER COUNTY.

PRECAUTIONARY/PREPAREDNESS ACTIONS...

THE SAFEST PLACE TO BE DURING A TORNADO IS IN A BASEMENT. GET UNDER A WORKBENCH OR OTHER PIECE OF STURDY FURNITURE. IF NO BASEMENT IS AVAILABLE...SEEK SHELTER ON THE LOWEST FLOOR OF THE BUILDING IN AN INTERIOR HALLWAY OR ROOM SUCH AS A CLOSET. USE BLANKETS OR PILLOWS TO COVER YOUR BODY AND ALWAYS STAY AWAY FROM WINDOWS.

IF IN MOBILE HOMES OR VEHICLES...EVACUATE THEM AND GET INSIDE A SUBSTANTIAL SHELTER. IF NO SHELTER IS AVAILABLE...LIE FLAT IN THE NEAREST DITCH OR OTHER LOW SPOT AND COVER YOUR HEAD WITH YOUR HANDS.

&&

LAT...LON 3716 9479 3707 9426 3697 9430 3701 9479

TIME...MOT...LOC 2216Z 247DEG 36KT 3708 9470

HAIL 1.75IN

\$\$

WISE

Appendix N

METHODS FOR DEVELOPMENT OF EVIDENCE–BASED EXPLANATION OF DECISION–MAKING IN THE JOPLIN TORNADO

The main analysis technique used to develop an evidence–based explanation of decision–making in the Joplin tornado was the analysis method framework (Framework) originally developed by Ritchie and Spencer (1994). The Framework allows the analyst to classify and organize survivor data into themes, concepts, and categories (Ritchie, Spencer, and O’Connor 2003), which can later be developed into a model.

This technique involved a four–step process: (1) data indexing, (2) data sorting, (3) data description, and (4) pattern detection. First, data indexing helps the analyst to organize or manage the data from interview transcripts. All interview transcripts were loaded into Atlas TI. Using a pre–developed code book (containing all categories and accompanying definitions that would be used to tag data later on in the process), analysts applied relevant codes (or data labels) to sections of text in each transcript (Richards and Richards 1994).

The next step was to sort the data so that the text with similar content or properties was located together (Ritchie, Spencer, and O’Connor 2003). In order to complete this step, NIST analysts ran “queries” within Atlas TI that allowed them to capture all text on a particular code or set of codes from all interviews (or a particular set of interviews). What resulted from each query was a document that contained all of the original text from each interview that corresponded with the particular code or set of codes.

Once the data were indexed and sorted, NIST analysts worked to describe the data. All data within a code or category were investigated to identify the range of the content and dimensions within the theme. In other words, the data within each main category was explored for axes of variation so that new, sub–categories could be developed. Once the subcategories within each main category were fully developed, a Microsoft Excel spreadsheet was created to organize all of this new data. A new row was added for each interviewee and all of the columns associated with each person contained data for each main category and the associated subcategories. As the analyst combined and condensed the data using the subcategories, the data became more abstract in nature, and the subcategories could be used in the next stage of the analysis.

The last stage in the Framework was pattern detection. This process allowed the analyst to find links and connections between two or more phenomena in the data (Ritchie, Spencer, and O’Connor 2003). During pattern detection, the data in the spreadsheet were sorted by a variety of factors, including the types of cues perceived, the interpretations developed from these cues, and the actions taken in response to the storm. Each time a behavioral trend was identified among the codes, categories, or subcategories, the analyst developed diagrams and memorandums to document the trend. Within the memorandums, the analyst noted how the level of matching was distributed across the data by recording what percentages of the interviewees were involved in a given behavioral trend. As multiple trends were identified, they were combined into a larger diagram known as an evidence–based explanation of decision–making. A model

to depict this explanation was developed for the 2011 Joplin tornado (see Fig. 4–41 in Chapter 4). The model highlights the factors that influenced NIST interviewees (the sampled survivors, i.e., “decision-makers”) to make decisions and take certain types of actions before the storm hit.

REFERENCES

- Richards, Lyn and Tom Richards. 1994. “From Filing Cabinet to Computer.” Pp. 146–172 in *Analyzing Qualitative Data*, edited by A. Bryman and R.G. Burgess. London: Routledge.
- Ritchie, Jane and Liz Spencer. 1994. “Qualitative Data Analysis for Applied Policy Research.” Pp. 173–194 in *Analyzing qualitative data*, edited by A. Bryman and R. G. Burgess. New York, NY: Taylor & Francis.
- Ritchie, Jane, Liz Spencer, and William O’Connor. 2003. “Carrying out Qualitative Analysis.” Pp. 219–262 in *Qualitative Research Practice, A Guide for Social Science Students and Resarchers*, edited by J. Ritchie and J. Lewis. Thousand Oaks, CA: Sage.

